

formalighting

**working  
catalogue**

**2018 | 19**







































## Products Index

Ala Pendant	283	MultiGiro	62
Ala Wall	285	MultiGiro Deep	67
Aqualuce	118	MultiQuadro	63
Arco	368	MultiQuadro Deep	68
Arena	70	Nano Round	208
Arena Due Surface	192	Nano Square	208
Arena Due Track	154	Nippo	108
Astra	358	Occhio Pin	113
Bullet Floodlight	326	Occhio Slot	115
Bullet Recessed	325	Ola Compasso	132
Canali	286	Optiwall	332
Circo	125	Orbit	344
Circo Pendant	229	Ovo	92
Circo Surface	205	Palla Compasso	146
Coco Pro	150	Palla Pendant	224
Colosseo	76	Palla Round Fixed	30
Comforto	120	Palla Round In & Out	29
Conos	158	Palla Round Wallwasher	31
Conos Due	198	Palla Square Fixed	34
Conos Pendant	234	Palla Square In & Out	33
Continuo	356	Palla Square Wallwasher	35
Cornetto	318	Palla Surface	182
Corolla	320	Piazza LED	58
Cubetto	210	Piazza LED Track	156
Cubox	370	PicoLED	242
Dado Surface	196	Pixo Pendant	216
Dado Track	164	Pixo Surface	172
Disco	342	Polaris	38
DomoLED Round	129	Polaris Pendant	218
DomoLED Round Pendant	239	Polaris Surface	176
DomoLED Round Surface	213	Polaris Track	144
DomoLED Square	130	Polaris Wallwasher	42
DomoLED Square Pendant	240	Polo	364
DomoLED Square Surface	214	Punto Round	96
Eclisse Pro	54	Punto Square	100
Edge	362	Quadro	126
FioreLED	322	Quadro Pendant	230
Flexstrip	244	Quadro Surface	206
Fontanaluce	312	QuadroLED	248
Forlinea	349	Rocket	346
Forlinea Pro	350	Roller In & Out	88
Fronteluce 90	352	Rolo Surface	195
Gala	342	Rolo Track	163
Galaxis Pro	122	Scudo Recessed	329
Galileo Due	337	Scudo Wall	330
Galileo Pendant	338	StellaLED	309
Galileo Surface	335	Sumo	232
Gimbalo	78	Terraluce	298
GirasolLED Round	372	Terraluce Linear	304
GirasolLED Square	372	Trafo	316
Girofix	61	Twist	187
GiroLED	248	Twist & Shout Round	48
Gola Pendant	270	Twist & Shout Square	48
Gola Recessed	254	Twist Deep	188
Gola Surface	260	Vela	174
Guideline	292	Venus Concave Round	13
Infinito	280	Venus Concave Square	18
InoxLED	310	Venus Round	15
Iride	50	Venus Square	20
Mago Round	25	Venus Wallwasher Round	17
Mago Square	26	Venus Wallwasher Square	22
Mago Surface	170	Visor	366
Micron	106	Zero Compasso	134
Miniluce Pendant	236	Zero Due	178
Miniluce Surface	202	Zero Due Track	136
MonoLED	247	Zero Pendant	220
MultiArena	72	Zero Projector	140
MultiGimbalo	82	Zoom	44

## Indoor Lighting

### Recessed









Venus Round	Venus Square	Mago Round	Mago Square	Palla Round	Palla Square
					
13	18	25	26	28	32
Polaris	Zoom	Twist & Shout Round	Twist & Shout Square	Iride	Eclisse Pro
					
38	44	48	48	50	54
Piazza LED	Girofix	MultiGiro	MultiQuadro	MultiGiro Deep	MultiQuadro Deep
					
58	61	62	63	67	68
Arena	MultiArena	Colosseo	Gimbalo	MultiGimbalo	Roller In & Out
					
70	72	76	78	82	88
Ovo	Punto Round	Punto Square	Micron	Nippo Round	Nippo Square
					
92	96	100	106	109	110
Occhio Pin	Occhio Slot	Aqualuce Round	Aqualuce Square	Comforto	Galaxis Pro
					
113	115	118	118	120	122

## Indoor Lighting

### Recessed





















Circo	Quadro	DomoLED Round	DomoLED Square
			
125	126	129	130

### Track

Ola Compasso	Zero Compasso	Zero Due	Zero Projector	Polaris	Palla Compasso
					
132	134	136	140	144	146
Coco Pro	Arena Due	Piazza LED	Conos	Rolo	Dado
					
150	154	156	158	163	164
Eurotype Track System	Low Voltage Mini Track				
					
166	168				

## Indoor Lighting

### Surface

Mago  170	Pixo  172	Vela  174	Polaris  176	Zero Due  178	Palla  182
Twist Round  187	Twist Square  187	Twist Deep Round  188	Twist Deep Square  188	Arena Due  192	Rolo  195
Dado  196	Conos Due  198	Miniluce LED  202	Circo  205	Quadro  206	Nano Round  208
Nano Square  208	Cubetto  210	DomoLED Round  213	DomoLED Square  214		

### Pendant

Pixo  216	Polaris  218	Zero  220	Palla  224	Circo  229	Quadro  230
--	---	--	---	---	--

## Indoor Lighting









### Pendant

Sumo  232	Conos  234	Miniluce  236	DomoLED Round  239	DomoLED Square  240
--	---	--	---	--



































### Showcase

PicoLED  242	Flexstrip  244	MonoLED  247	GiroLED  248	QuadroLED  248
---	---	---	---	---

### Systems

Gola Recessed 40/60/95/160  254	Gola Wall 40/60/95/160  260	Gola Ceiling 40/60/95/160  266	Gola Pendant 40/60/95/160  270	Infinito  280	Ala Pendant  283
Ala Wall  285	Canali  286	Guideline  292			

## Outdoor Lighting

Terraluce  298	Teraluce Linear  304	StellaLED  309	InoxLED  310	Fontanaluce  312	Trafo  316
Cornetto  318	Corolla  320	FioreLED  322	Bullet Recessed  325	Bullet Floodlight  326	Scudo Recessed  329
Scudo Wall  331	Scudo Wall/Ground  330	Optiwall  332	Galileo Surface Mounted  334	Galileo Pendant  338	Disco  342
Gala  342	Orbit Round  344	Orbit Square  344	Rocket  346	Forlinea  349	Forlinea Pro  350
Fronteluce  352	Continuo  356	Astra  358	Edge  362	Polo  364	Visor  366
Arco  368	Cubox  370	GirasoLED Round  372	GirasoLED Square  372		

Welcome to the  
era of MOTOLUX

New series  
NOW available



**MOTOLUX**  
Motorized Remote Controlled Lighting

All its power in your hands

**revolutionary lighting technology controlled at the touch of a button**

MOTOLUX, an award winning, revolutionary lighting concept using patented technology to easily and fully control light orientation, intensity and tune the white colour temperature by a hand held transmitter or CASAMBI™ or DMX-512.

The elegant design of Moto-Ola discreetly incorporates advanced engineered miniature motors, controlled at the touch of a button by the Motolux patented remote control technology to select

an individual or infinite group of fixtures (from floor-level and from a distance of up to 12 meters) and drive tilt movements up to +/- 100° and pan movements up to +/- 160°.

Moto-Ola stands out from the crowd thanks to its elegant design united with fine Italian craftsmanship. With its flexibility in light direction and ease for frequent changes of light scenes is the ideal solution for museum and hospitality environments.

\* For complete information, please check our MOTOLUX brochure or go to our website.

# Venus

Recessed Round & Square 70 / 125

## Concave Fixed & Adjustable



## Fixed & Adjustable



## Wallwasher



## Body

Round or square luminaire with concave or flat shape.

Mounting trim in cast aluminium with brackets for trim installation on ceiling thickness max. 32mm or trimless installation on ceiling thickness max. 25mm.

Luminaire body in cast aluminium with catch retainer for easy trim insertion/removal and integrated steel sheet, inclusive of tool-less locking point and safety cable.

Adjustable version tiltable vertically up to 40° and rotatable horizontally 350°.

## Accessories

Snap System™ accessories available for SORAA SLE series with narrow beam angle.

## Finish

Powder coat in black or white colour.

## LED sources

Citizen CLU Series, Xicato Artist, Beauty and Designer Series, SORAA SLE Optical Light Engine.  
CRI: 90, 95, 98 | CCT: 2700K, 3000K, 4000K.  
Other CRI and CCT options, Tuneable White and DimToWarm versions available on request.

## Related Products



## Optic

Reflector + diffuser. Narrow, medium and wide beam angle available.

## Driver

Supplied with No-dimable remote driver.  
Dimming Options: 0-10V Dim, DALI, Phase, CASAMBI.

## Applications

Represent the pinnacle of innovation and design of small aperture recessed luminaires that easily blend into the architecture to meet the need of designers.  
Application areas: retail, showrooms, residential, restaurants, hotels.

# Venus Concave Round



## Venus 125 Concave Fixed Round Trim

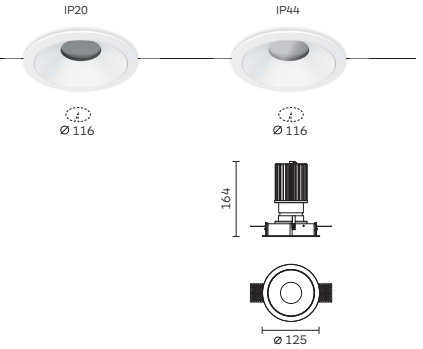

## Venus 125 Concave Fixed Round Trimless

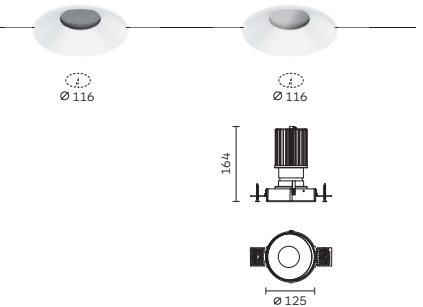

Code ordering example: **R 0 1 9 M C 2 2 - 9 0 3 0 2 0 0 1 0**

	Product Code	Ingress Protection	Light Source Code*	>CRI	CCT**	LED Power	Nominal Lumen	Beam Angle (BA°)	Driver Options	Finish
Venus Concave 125	<b>RO19</b>	IP20	<b>MC22</b>	<b>90</b>	<b>30</b> 3000K	22W	2418 lm	<b>20 / 32</b>	<b>D0</b> No Dim	<b>10</b> Black
Fixed Round	<b>RO20</b>				<b>40</b> 4000K		2456 lm		<b>DA</b> Dali Dim	<b>11</b> White
	<b>RO21</b>	IP44							<b>DP</b> Phase Dim	
	<b>RO22</b>								<b>DC</b> CASAMBI	
									<b>D1</b> 0-10V Dim	

## Notes:

\* For complete code ordering information, please see page 377.

\*\* For other CCT options, please contact us.

## Venus Concave Round

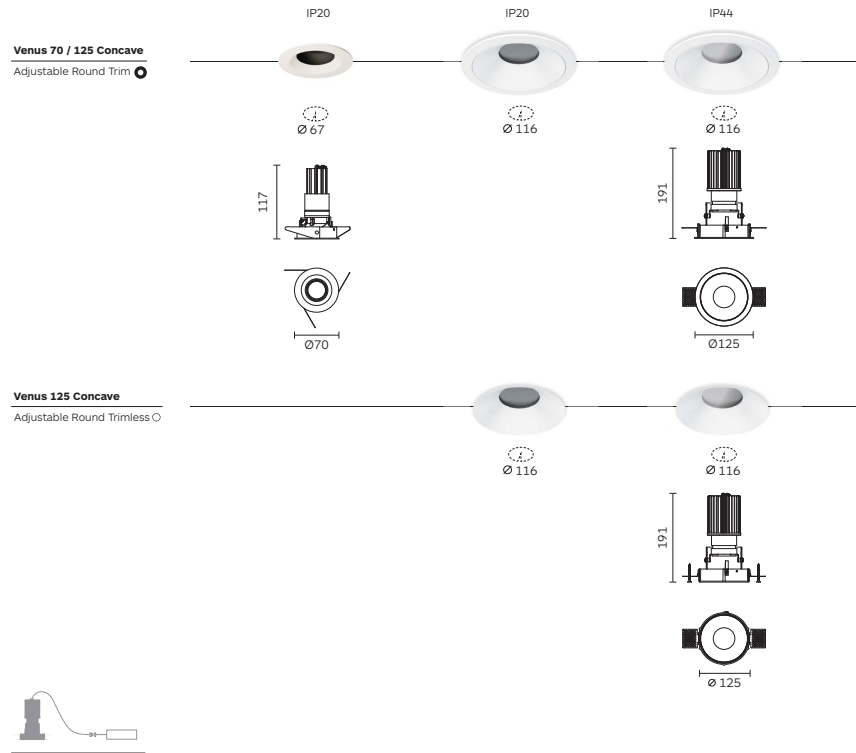

Code ordering example: **R 0 4 0 M C 3 1 - 9 0 3 0 1 2 D 0 1 0**

	Product Code	Ingress Protection	Light Source Code*	>CRI	CCT**	LED Power	Nominal Lumen	Beam Angle (BA°)	Driver Options	Finish
Venus Concave 70 Adjustable Round	<b>RO40</b> ○	IP20	<b>MC31</b>	<b>90</b>	<b>30</b> 3000K	6W	616 lm	<b>12 / 24 / 32</b>	<b>D0</b> No Dim	<b>10</b> ■ Black
					<b>40</b> 4000K		643 lm		<b>DA</b> Dali Dim	<b>11</b> □ White
Venus Concave 125 Adjustable Round	<b>RN59</b> ○		<b>MC22</b>			22W	2418 lm	<b>20 / 32</b>	<b>DP</b> Phase Dim	
							2456 lm		<b>DC</b> CASAMBI	
									<b>D1</b> 0-10V Dim	

**Notes:**  
 \* For complete code ordering information, please see page 377.  
 \*\* For other CCT options, please contact us.

## Venus Round

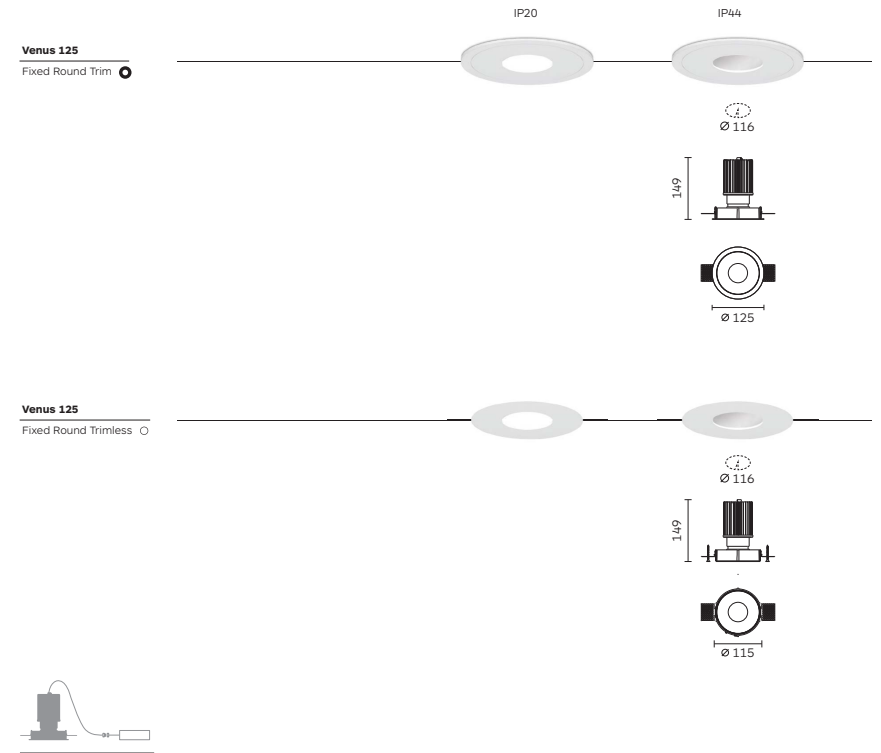

Code ordering example: **R G 3 8 M C 2 2 - 9 0 3 0 2 0 D 0 1 0**

	Product Code	Ingress Protection**	Light Source Code*	>CRI	CCT**	LED Power	Nominal Lumen	Beam Angle (BA°)	Driver Options	Finish
Venus 125 Fixed Round	<b>RG38</b> ○	IP20	<b>MC22</b>	<b>90</b>	<b>30</b> 3000K	22W	2418 lm	<b>20 / 32</b>	<b>D0</b> No Dim	<b>10</b> ■ Black
					<b>40</b> 4000K		2456 lm		<b>DA</b> Dali Dim	<b>11</b> □ White
Venus 125 Fixed Round Trimless	<b>RO24</b> ○	IP44							<b>DP</b> Phase Dim	
									<b>DC</b> CASAMBI	
									<b>D1</b> 0-10V Dim	

**Notes:**  
 \* For complete code ordering information, please see page 377.  
 \*\* For other CCT options, please contact us.



# Venus Round

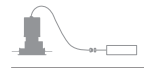
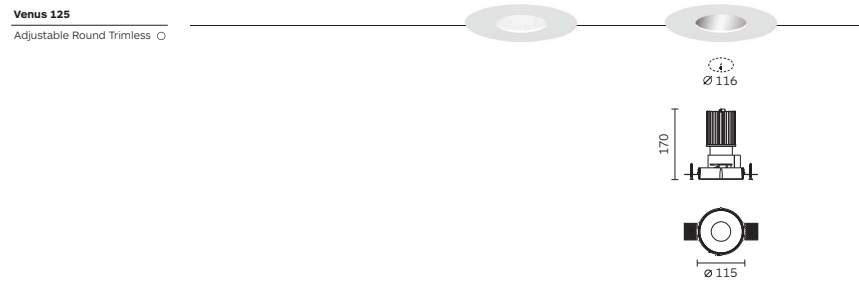
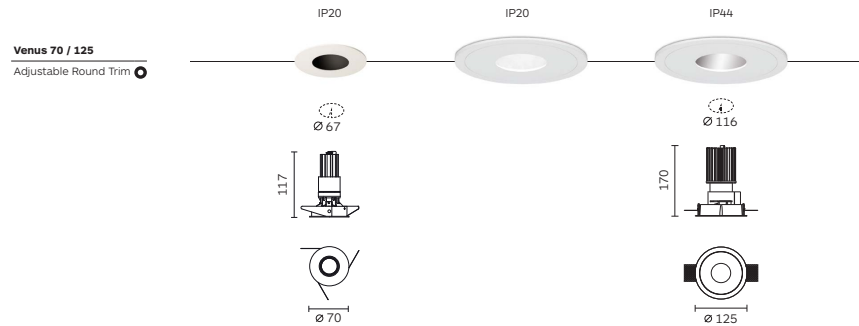

Code ordering example: **R 0 3 8 M C 3 1 - 9 0 3 0 1 2 D 0 1 0**

	Product Code	Ingress Protection**	Light Source Code*	>CRI	CCT**	LED Power	Nominal Lumen	Beam Angle (BA°)	Driver Options	Finish
Venus 70 Adjustable Round	<b>RO38</b> <input checked="" type="radio"/>	IP20	<b>MC31</b>	<b>90</b>	<b>30</b> 3000K	6W	616 lm	<b>12 / 24 / 32</b>	<b>D0</b> No Dim	<b>10</b> <input checked="" type="checkbox"/> Black
				<b>40</b>	4000K		643 lm		<b>DA</b> Dali Dim	<b>11</b> <input type="checkbox"/> White
Venus 125 Adjustable Round	<b>RG30</b> <input checked="" type="radio"/>		<b>MC22</b>			22W	2418 lm	<b>20 / 32</b>	<b>DP</b> Phase Dim	
	<b>RG31</b> <input type="radio"/>						2456 lm		<b>DC</b> CASAMBI	
	<b>RO25</b> <input checked="" type="radio"/>	IP44							<b>D1</b> 0-10V Dim	
	<b>RO29</b> <input type="radio"/>									

**Notes:**  
 \* For complete code ordering information, please see page 377.  
 \*\* For other CCT options, please contact us.

# Venus Round



Code ordering example: **R G 4 6 M C 2 2 - 9 0 3 0 W W D 0 1 0**

	Product Code	Ingress Protection**	Light Source Code*	>CRI	CCT**	LED Power	Nominal Lumen	Beam Angle (BA°)	Driver Options	Finish
Venus 125 Wallwasher Round	<b>RG46</b> <input checked="" type="radio"/>	IP40	<b>MC22</b>	<b>90</b>	<b>30</b> 3000K	22W	2418 lm	<b>WW</b>	<b>D0</b> No Dim	<b>10</b> <input checked="" type="checkbox"/> Black
	<b>RG47</b> <input type="radio"/>				<b>40</b> 4000K		2456 lm		<b>DA</b> Dali Dim	<b>11</b> <input type="checkbox"/> White
									<b>DP</b> Phase Dim	
									<b>DC</b> CASAMBI	
									<b>D1</b> 0-10V Dim	

**Notes:**  
 \* For complete code ordering information, please see page 377.  
 \*\* For other CCT options, please contact us.  
 IP44 version available on request.

# Venus Concave Square



**Venus 125 Concave**  
Fixed Square Trim

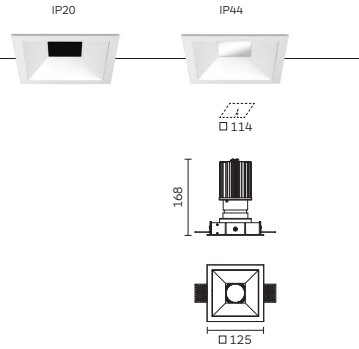

**Venus 125 Concave**  
Fixed Square Trimless

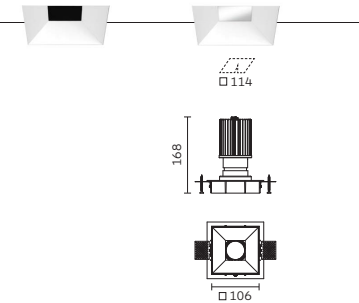

Code ordering example: **R H 5 2 M C 2 2 - 9 0 3 0 2 0 D 0 1 0**

	Product Code	Ingress Protection	Light Source Code*	>CRI	CCT**	LED Power	Nominal Lumen	Beam Angle (BA°)	Driver Options	Finish
Venus 125 Concave Fixed Square	<b>RH52</b> <input checked="" type="checkbox"/>	IP20	<b>MC22</b>	<b>90</b>	<b>30</b> 3000K	22W	2418 lm	<b>20 / 32</b>	<b>D0</b> No Dim	<b>10</b> <input checked="" type="checkbox"/> Black
	<b>RH54</b> <input type="checkbox"/>				<b>40</b> 4000K		2456 lm		<b>DA</b> Dali Dim	<b>11</b> <input type="checkbox"/> White
	<b>RJ03</b> <input checked="" type="checkbox"/>	IP44							<b>DP</b> Phase Dim	
	<b>RJ05</b> <input type="checkbox"/>								<b>DC</b> CASAMBI	
									<b>D1</b> 0-10V Dim	

**Notes:**  
\* For complete code ordering information, please see page 377.  
\*\* For other CCT options, please contact us.

# Venus Concave Square



**Venus 70 / 125 Concave**  
Adjustable Square Trim

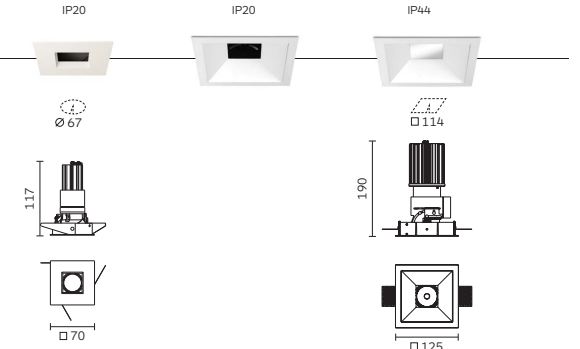

**Venus 125 Concave**  
Adjustable Square Trimless

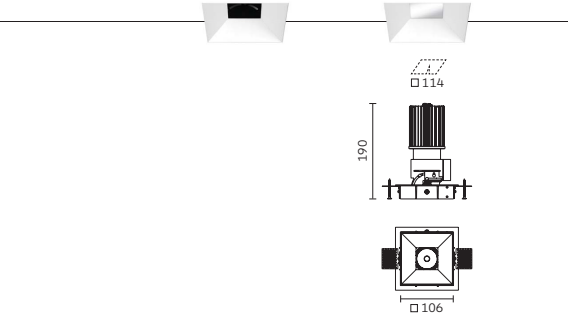

Code ordering example: **R O 4 1 M C 3 1 - 9 0 3 0 1 2 D 0 1 0**

	Product Code	Ingress Protection	Light Source Code*	>CRI	CCT**	LED Power	Nominal Lumen	Beam Angle (BA°)	Driver Options	Finish
Venus 70 Concave Adjustable Square	<b>RO41</b> <input checked="" type="checkbox"/>	IP20	<b>MC31</b>	<b>90</b>	<b>30</b> 3000K	6W	610 lm	<b>12 / 24 / 32</b>	<b>D0</b> No Dim	<b>10</b> <input checked="" type="checkbox"/> Black
					<b>40</b> 4000K		643 lm		<b>DA</b> Dali Dim	<b>11</b> <input type="checkbox"/> White
Venus 125 Concave Adjustable Square	<b>RH51</b> <input checked="" type="checkbox"/>		<b>MC22</b>			22W	2418 lm	<b>20 / 32</b>	<b>DP</b> Phase Dim	
	<b>RH53</b> <input type="checkbox"/>						2456 lm		<b>DC</b> CASAMBI	
	<b>RJ02</b> <input checked="" type="checkbox"/>	IP44							<b>D1</b> 0-10V Dim	
	<b>RJ04</b> <input type="checkbox"/>									

**Notes:**  
\* For complete code ordering information, please see page 377.  
\*\* For other CCT options, please contact us.

# Venus Square



**Venus 125**  
Fixed Square Trim

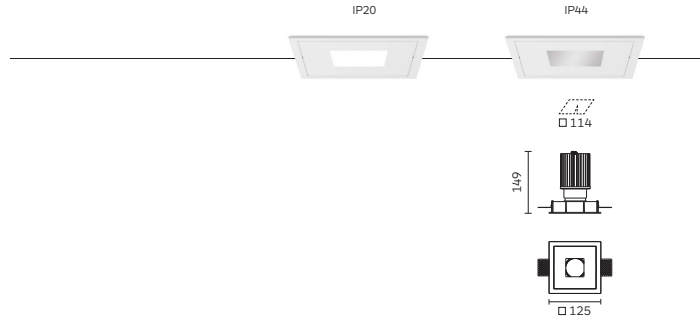

**Venus 125**  
Fixed Square Trimless

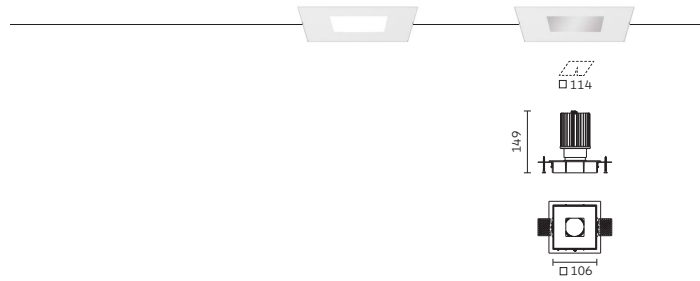

Code ordering example: **R G 7 8 M C 2 2 - 9 0 3 0 2 0 D 0 1 0**

	Product Code	Ingress Protection**	Light Source Code*	>CRI	CCT**	LED Power	Nominal Lumen	Beam Angle (BA°)	Driver Options	Finish
Venus 125 Fixed Square	<b>RG78</b> <input type="checkbox"/>	IP20	<b>MC22</b>	<b>90</b>	<b>30</b> 3000K	22W	2418 lm	<b>20 / 32</b>	<b>D0</b> No Dim	<b>10</b> <input type="checkbox"/> Black
	<b>RG79</b> <input type="checkbox"/>				<b>40</b> 4000K		2456 lm		<b>DA</b> Dali Dim	<b>11</b> <input type="checkbox"/> White
	<b>RO26</b> <input type="checkbox"/>	IP44							<b>DP</b> Phase Dim	
	<b>RO30</b> <input type="checkbox"/>								<b>DC</b> CASAMBI	
									<b>D1</b> 0-10V Dim	

**Notes:**  
\* For complete code ordering information, please see page 377.  
\*\* For other CCT options, please contact us.

# Venus Square



**Venus 70 / 125**  
Adjustable Square Trim

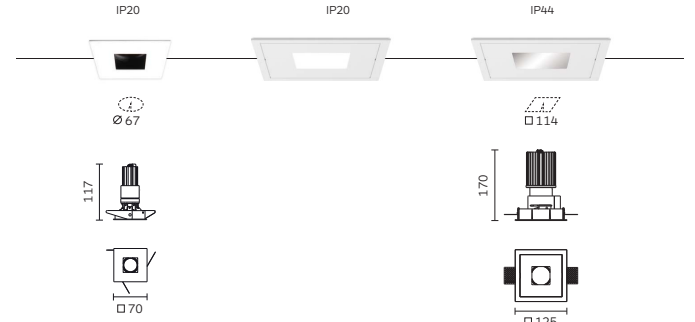

**Venus 125**  
Adjustable Square Trimless

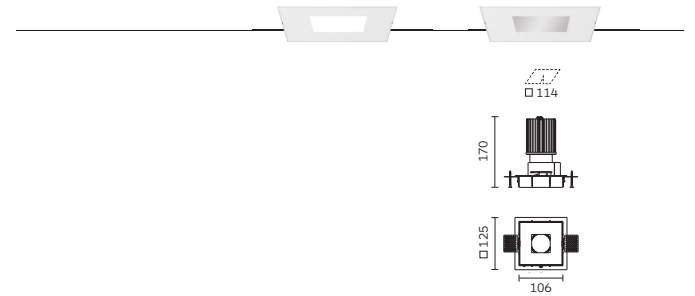

Code ordering example: **R O 3 9 M C 3 1 - 9 0 3 0 1 2 D 0 1 0**

	Product Code	Ingress Protection	Light Source Code*	>CRI	CCT**	LED Power	Nominal Lumen	Beam Angle (BA°)	Driver Options	Finish
Venus 70 Adjustable Square	<b>RO39</b> <input type="checkbox"/>	IP20	<b>MC31</b>	<b>90</b>	<b>30</b> 3000K	6W	616 lm	<b>12 / 24 / 32</b>	<b>D0</b> No Dim	<b>10</b> <input type="checkbox"/> Black
					<b>40</b> 4000K		643 lm		<b>DA</b> Dali Dim	<b>11</b> <input type="checkbox"/> White
Venus 125 Adjustable Square	<b>RG70</b> <input type="checkbox"/>		<b>MC22</b>			22W	2418 lm	<b>20 / 32</b>	<b>DP</b> Phase Dim	
	<b>RG71</b> <input type="checkbox"/>						2456 lm		<b>DC</b> CASAMBI	
	<b>RO27</b> <input type="checkbox"/>	IP44							<b>D1</b> 0-10V Dim	
	<b>RO31</b> <input type="checkbox"/>									

**Notes:**  
\* For complete code ordering information, please see page 377.  
\*\* For other CCT options, please contact us.

# Venus Square



**Venus 125**  
Wallwasher Square Trim

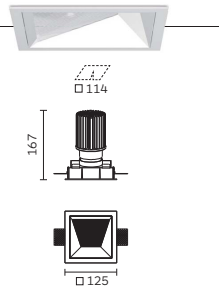

**Venus 125**  
Wallwasher Square Trimless

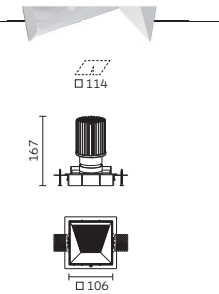

Code ordering example: R G 5 2 M C 2 2 - 9 0 3 0 W W D 0 1 0

	Product Code	Ingress Protection	Light Source Code*	>CRI	CCT**	LED Power	Nominal Lumen	Beam Angle (BA°)	Driver Options	Finish
Venus 125 Wallwasher Square	<b>RG52</b>	<input checked="" type="checkbox"/> IP40	<b>MC22</b>	<b>90</b>	<b>30</b> 3000K	22W	2418 lm	<b>WW</b>	<b>D0</b> No Dim	<b>10</b> <input checked="" type="checkbox"/> Black
	<b>RG53</b>	<input type="checkbox"/>			<b>40</b> 4000K		2456 lm		<b>DA</b> Dali Dim <b>DP</b> Phase Dim <b>DC</b> CASAMBI <b>D1</b> 0-10V Dim	<b>11</b> <input type="checkbox"/> White

**Notes:**  
\* For complete code ordering information, please see page 377.  
\*\* For other CCT options, please contact us.  
IP44 version available on request.

# Venus Recessed Family configuration options

Code ordering example: R 0 3 8 M C 3 1 - 9 0 3 0 1 2 D 0 1 0

## Venus 70 Round & Square

\*Concave Adjustable | Adjustable

Product Code	Ingress Protection	Light Source Code	>CRI	CCT	LED Power	Nominal Lumen	Beam Angle (BA°)	Driver Options	Finish
<b>RO38</b> <input checked="" type="checkbox"/> Adjustable	IP20	<b>MC31</b> Citizen COB	<b>90</b>	<b>30</b> 3000K	6W	616 lm	<b>12 / 24 / 32</b>	<b>D0</b> No Dim	<b>10</b> <input checked="" type="checkbox"/> Black
<b>RO40</b> <input checked="" type="checkbox"/> Adjustable*	IP20			<b>40</b> 4000K		643 lm		<b>DA</b> Dali Dim	<b>11</b> <input type="checkbox"/> White
<b>RO39</b> <input checked="" type="checkbox"/> Adjustable	IP20	<b>MS62</b> Soraa SLE-11	<b>95</b>		6.7W	430 lm	<b>25 / 36</b>	<b>DP</b> Phase Dim	
<b>RO41</b> <input checked="" type="checkbox"/> Adjustable*	IP20					450 lm		<b>DC</b> CASAMBI <b>D1</b> 0-10V Dim	

## Venus 125 Round & Square

\*Concave Fixed & Adjustable | Fixed | Adjustable | \*\*Wallwasher

Product Code	Ingress Protection	Light Source Code	>CRI	CCT	LED Power	Nominal Lumen	Beam Angle (BA°)	Driver Options	Finish
<b>RO19</b> <input checked="" type="checkbox"/> Fixed*	IP20	<b>MC22</b> Citizen COB	<b>90</b>	<b>30</b> 3000K	22W	2418 lm	<b>20 / 32 / WW**</b>	<b>D0</b> No Dim	<b>10</b> <input checked="" type="checkbox"/> Black
<b>RO20</b> <input type="checkbox"/> Fixed*	IP20			<b>40</b> 4000K		2456 lm		<b>DA</b> Dali Dim	<b>11</b> <input type="checkbox"/> White
<b>RO21</b> <input checked="" type="checkbox"/> Fixed*	IP44	<b>MS11</b> Soraa SLE-16	<b>95</b>		8.1W	460 lm	<b>10</b>	<b>DP</b> Phase Dim	
<b>RO22</b> <input type="checkbox"/> Fixed*	IP44					480 lm		<b>DC</b> CASAMBI	
<b>RG38</b> <input checked="" type="checkbox"/> Fixed	IP20				12.2W	720 lm	<b>15 / 25 / 36</b>	<b>D1</b> 0-10V Dim	
<b>RG39</b> <input type="checkbox"/> Fixed	IP20					755 lm			
<b>RO24</b> <input checked="" type="checkbox"/> Fixed	IP44	<b>MX22</b> Xicato Artist XTM	<b>98</b>	<b>27</b> 2700K	10.6W	700 lm	<b>16 / 28 / 38</b>		
<b>RO28</b> <input type="checkbox"/> Fixed	IP44	<b>MX61</b> XIM			11.5W				
<b>RN59</b> <input checked="" type="checkbox"/> Adjustable*	IP20	<b>MX31</b> Beauty XTM	<b>95</b>		9.5W	931 lm	<b>28 / 35 / 45</b>		
<b>RN60</b> <input type="checkbox"/> Adjustable*	IP20	<b>MX71</b> XIM			11.5W				
<b>RN61</b> <input checked="" type="checkbox"/> Adjustable*	IP44	<b>MX41</b> Designer XTM	<b>90</b>		11.4W	1300 lm			
<b>RN62</b> <input type="checkbox"/> Adjustable*	IP44	<b>MX81</b> XIM			13.2W				
<b>RG30</b> <input type="checkbox"/> Adjustable	IP20	<b>GU53</b> Retrofit MR16-GU5.3	<b>00</b>	<b>00</b>	/	/	<b>00</b>	<b>00</b> No Driver	
<b>RG31</b> <input type="checkbox"/> Adjustable	IP20								
<b>RO25</b> <input checked="" type="checkbox"/> Adjustable	IP44								
<b>RO29</b> <input type="checkbox"/> Adjustable	IP44								
<b>RG46</b> <input checked="" type="checkbox"/> Wallwasher	IP40								
<b>RG47</b> <input type="checkbox"/> Wallwasher	IP40								
<b>RH52</b> <input checked="" type="checkbox"/> Fixed*	IP20								
<b>RH54</b> <input type="checkbox"/> Fixed*	IP20								
<b>RJ03</b> <input checked="" type="checkbox"/> Fixed*	IP44								
<b>RJ05</b> <input type="checkbox"/> Fixed*	IP44								
<b>RG78</b> <input checked="" type="checkbox"/> Fixed	IP20								
<b>RG79</b> <input type="checkbox"/> Fixed	IP20								
<b>RO26</b> <input checked="" type="checkbox"/> Fixed	IP44								
<b>RO30</b> <input type="checkbox"/> Fixed	IP44								
<b>RH51</b> <input checked="" type="checkbox"/> Adjustable*	IP20								
<b>RH53</b> <input type="checkbox"/> Adjustable*	IP20								
<b>RJ02</b> <input checked="" type="checkbox"/> Adjustable*	IP44								
<b>RJ04</b> <input type="checkbox"/> Adjustable*	IP44								
<b>RG70</b> <input checked="" type="checkbox"/> Adjustable	IP20								
<b>RG71</b> <input type="checkbox"/> Adjustable	IP20								
<b>RO27</b> <input checked="" type="checkbox"/> Adjustable	IP44								
<b>RO31</b> <input type="checkbox"/> Adjustable	IP44								
<b>RG52</b> <input checked="" type="checkbox"/> Wallwasher	IP40								
<b>RG53</b> <input type="checkbox"/> Wallwasher	IP40								

**Notes:**  
For other CCT options, please contact us.

# Mago

Recessed Round & Square 115 | 145



## Body

Round or square shape mounting trim in cast aluminium with brackets for trim installation on ceiling thickness max. 25 mm or trimless installation on ceiling thickness max. 30 mm.

Luminaire body in cast aluminium inclusive of a convex lens. Transparent safety cover included.

## LED sources

Citizen CLU Series.  
CRI: 90 | CCT: 3000K, 4000K.  
Other CRI and CCT options, Tuneable White and DimToWarm versions available on request.

## Optic

Convex Lens.  
Wide beam angle available.

## Accessories

No accessories available.

## Finish

Powder coat in black and white colour.

## Driver

Supplied with No-dimable remote driver.  
Dimming Options: 0-10V Dim, DALI, Phase, CASAMBI.

## Applications

The revolutionary convex lens provides an evenly and effective light, minimizing the glare. Its affordable price combined with its wide light distribution, make it the ideal solution for a vast range of uses.  
Application areas: office, hotels, restaurants, lobbies, corridors, conference rooms.

## Related Products



## Mago Round



**Mago 115 / 145**  
Round Trim



Ø 120



Ø 150

**Mago 115 / 145**  
Round Trimless



Ø 132



Ø 162

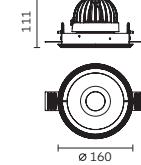
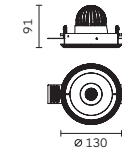

Code ordering example: **R N 8 6 B C 2 2 - 9 0 3 0 4 0 D 0 1 0**

	Product Code	Light Source Code*	>CRI	CCT**	LED Power	Nominal Lumen	Beam Angle (BA°)	Driver Options	Finish
Mago 115 Round	<b>RN86</b> <input checked="" type="radio"/>	<b>BC22</b>	<b>90</b>	<b>30</b> 3000K	12W	1500 lm	<b>40</b>	<b>D0</b> No Dim	<b>10</b> <input checked="" type="checkbox"/> Black
	<b>RN87</b> <input type="radio"/>			<b>40</b> 4000K		1600 lm		<b>DA</b> Dali Dim	<b>11</b> <input type="checkbox"/> White
Mago 145 Round	<b>RN90</b> <input checked="" type="radio"/>	<b>BC33</b>			21W	2200 lm	<b>45</b>	<b>DP</b> Phase Dim	
	<b>RN91</b> <input type="radio"/>					2350 lm		<b>DC</b> CASAMBI	
								<b>D1</b> 0-10V Dim	

### Notes:

\* For complete code ordering information, please see page 377.

\*\* For other CCT options, please contact us.

# Mago Square



**Mago 115 / 145**  
Square Trim

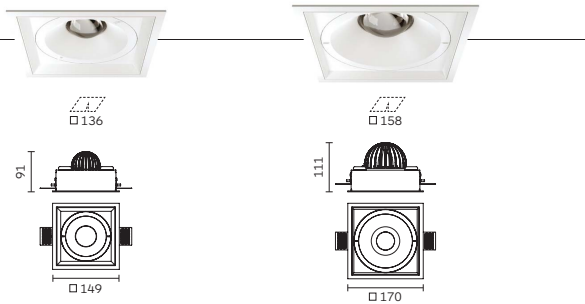

**Mago 115 / 145**  
Square Trimless

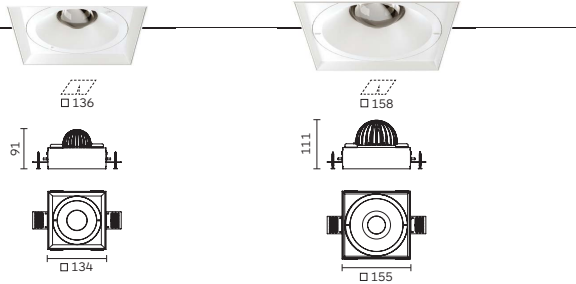

Code ordering example: **R N 9 6 B C 2 2 - 9 0 3 0 4 0 D 0 1 0**

	Product Code	Light Source Code*	>CRI	CCT**	LED Power	Nominal Lumen	Beam Angle (BA°)	Driver Options	Finish
Mago 115 Fixed Square	<b>RN96</b> <input checked="" type="checkbox"/>	<b>BC22</b>	<b>90</b>	<b>30</b> 3000K	12W	1500 lm	<b>40</b>	<b>D0</b> No Dim	<b>10</b> <input checked="" type="checkbox"/> Black
	<b>RN97</b> <input type="checkbox"/>			<b>40</b> 4000K		1600 lm		<b>DA</b> Dali Dim	<b>11</b> <input type="checkbox"/> White
Mago 145 Fixed Square	<b>RO01</b> <input checked="" type="checkbox"/>	<b>BC33</b>			21W	2200 lm	<b>45</b>	<b>DP</b> Phase Dim	
	<b>RO02</b> <input type="checkbox"/>					2350 lm		<b>DC</b> CASAMBI <b>D1</b> 0-10V Dim	

**Notes:**  
\* For complete code ordering information, please see page 377.  
\*\* For other CCT options, please contact us.

# Mago Recessed Family configuration options

Code ordering example: **R N 8 6 B C 2 2 - 9 0 3 0 4 0 D 0 1 0**

## Mago 115 Round & Square

Fixed

Product Code	Light Source Code	>CRI	CCT	LED Power	Nominal Lumen	Beam Angle (BA°)	Driver Options	Finish
<b>RN86</b> <input checked="" type="checkbox"/>	<b>BC22</b> Citizen COB	<b>90</b>	<b>30</b> 3000K	12W	1500 lm	<b>40</b>	<b>D0</b> No Dim	<b>10</b> <input checked="" type="checkbox"/> Black
<b>RN87</b> <input type="checkbox"/>			<b>40</b> 4000K		1600 lm		<b>DA</b> Dali Dim	<b>11</b> <input type="checkbox"/> White
<b>RN96</b> <input checked="" type="checkbox"/>							<b>DP</b> Phase Dim	
<b>RN97</b> <input type="checkbox"/>							<b>DC</b> CASAMBI <b>D1</b> 0-10V Dim	

## Mago 145 Round & Square

Fixed

Product Code	Light Source Code	>CRI	CCT	LED Power	Nominal Lumen	Beam Angle (BA°)	Driver Options	Finish
<b>RN90</b> <input checked="" type="checkbox"/>	<b>BC33</b> Citizen COB	<b>90</b>	<b>30</b> 3000K	21W	2200 lm	<b>45</b>	<b>D0</b> No Dim	<b>10</b> <input checked="" type="checkbox"/> Black
<b>RN91</b> <input type="checkbox"/>			<b>40</b> 4000K		2350 lm		<b>DA</b> Dali Dim	<b>11</b> <input type="checkbox"/> White
<b>RO01</b> <input checked="" type="checkbox"/>							<b>DP</b> Phase Dim	
<b>RO02</b> <input type="checkbox"/>							<b>DC</b> CASAMBI <b>D1</b> 0-10V Dim	

**Notes:**  
For other CCT options, please contact us.

# Palla

Designed by **Franco Mireni** (Registered)

## In & Out



## Fixed



## Wallwasher



## Body

Round shape mounting trim in cast aluminium with brackets for trim installation on ceiling thickness max. 25 mm or trimless installation on ceiling thickness max. 30 mm.

Luminaire body in cast aluminium and (only for In&Out version) thermoplastic material. Transparent safety cover included. Available in three different sizes.

In&Out version tiltable vertically in two directions (0°-30° In, 0-60° Out) and rotatable horizontally 350°.

## Accessories

Honeycomb louvre.  
Snap System™ accessories available for SORAA SLC series with narrow beam angle.

## Finish

Powder coat in black and white colour.

## LED sources

Citizen CLU Series. Xicato Artist, Beauty and Designer Series. SORAA SLC Optical Light Engine.  
CRI: 90, 95, 98 | CCT: 2700K, 3000K, 4000K.  
Other CRI and CCT options, Tuneable White and DimToWarm versions available on request.

## Optic

Lens.  
Narrow, medium and wide beam angle available.

## Driver

Supplied with No-dimable remote driver.  
Dimming Options: 0-10V Dim, DALI, Phase, CASAMBI.

## Applications

These series of downlights is designed to deliver superior performance, maximum versatility with fast-easy installation and allow lamp aiming while the power is on.  
Application areas: retail, hotels, restaurants, offices, lobbies.

## Related Products

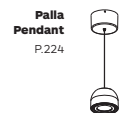
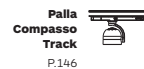

## Palla



### Palla 70 / 100 / 130

In & Out Round Trim



### Palla 70 / 100 / 130

In & Out Round Trimless

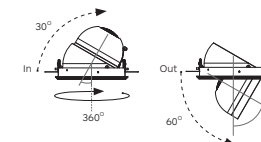
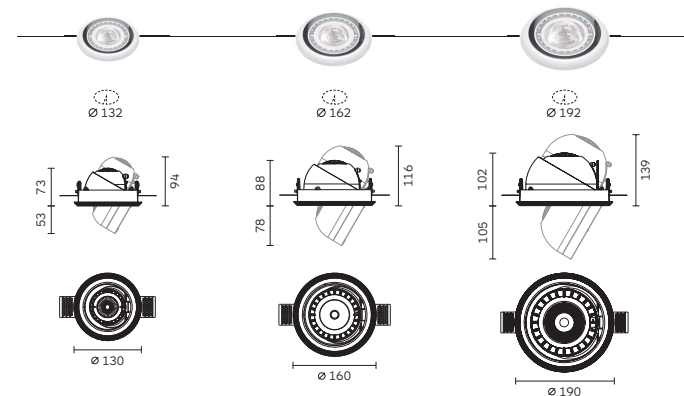

Code ordering example: **R N 6 6 B C 2 2 - 9 0 3 0 1 6 D 0 1 0**

	Product Code	Light Source Code*	>CRI	CCT**	LED Power	Nominal Lumen	Beam Angle (BA°)	Driver Options	Finish
Palla 70	<b>RN66</b>	<b>BC22</b>	<b>90</b>	<b>30</b> 3000K	12W	1500 lm	<b>16 / 25 / 36</b>	<b>D0</b> No Dim	<b>10</b> Black
In & Out Round	<b>RN67</b>			<b>40</b> 4000K		1520 lm		<b>DA</b> Dali Dim	<b>11</b> White
Palla 100	<b>RN68</b>	<b>BC33</b>			21W	2200 lm	<b>15 / 24 / 38</b>	<b>DP</b> Phase Dim	
In & Out Round	<b>RN69</b>					2300 lm		<b>DC</b> CASAMBI	
Palla 130	<b>RN70</b>	<b>BC33</b>			33W	3220 lm	<b>12 / 22 / 32</b>	<b>D1</b> 0-10V Dim	
In & Out Round	<b>RN71</b>					3300 lm			

### Notes:

\* For complete code ordering information, please see page 377.

\*\* For other CCT options, please contact us.

For related accessories, please see page 37.

## Palla



## Palla 70 / 100 / 130

Fixed Round Trim

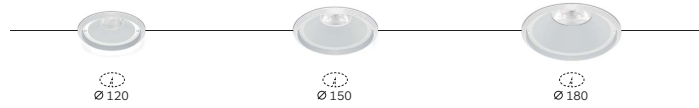

## Palla 70 / 100 / 130

Fixed Round Trimless

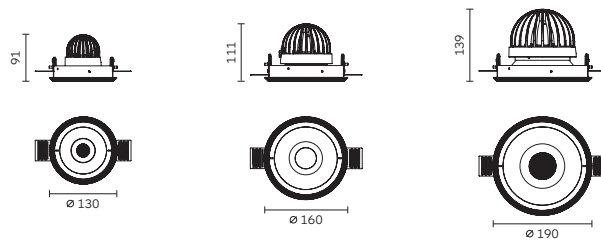
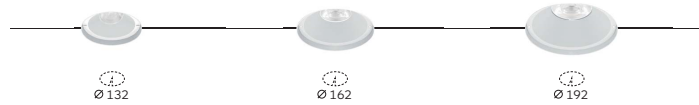
Code ordering example: **R N 8 4 B C 2 2 - 9 0 3 0 1 6 D 0 1 0**

	Product Code	Light Source Code*	>CRI	CCT**	LED Power	Nominal Lumen	Beam Angle (BA°)	Driver Options	Finish
Palla 70 Fixed Round	<b>RN84</b>	<b>BC22</b>	<b>90</b>	<b>30</b> 3000K	12W	1500 lm	<b>16 / 25 / 36</b>	<b>D0</b> No Dim	<b>10</b> Black
	<b>RN85</b>			<b>40</b> 4000K		1520 lm		<b>DA</b> Dali Dim	<b>11</b> White
Palla 100 Fixed Round	<b>RN88</b>	<b>BC33</b>			21W	2200 lm	<b>15 / 24 / 38</b>	<b>DP</b> Phase Dim	
	<b>RN89</b>					2300 lm		<b>DC</b> CASAMBI	
Palla 130 Fixed Round	<b>RN92</b>	<b>BC33</b>			33W	3220 lm	<b>12 / 22 / 32</b>	<b>D1</b> 0-10V Dim	
	<b>RN93</b>					3300 lm			

## Notes:

- \* For complete code ordering information, please see page 377.
  - \*\* For other CCT options, please contact us.
- For related accessories, please see page 37.

## Palla



## Palla 70 / 100 / 130

Wallwasher Round Trim

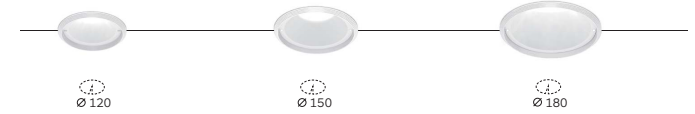

## Palla 70 / 100 / 130

Wallwasher Round Trimless

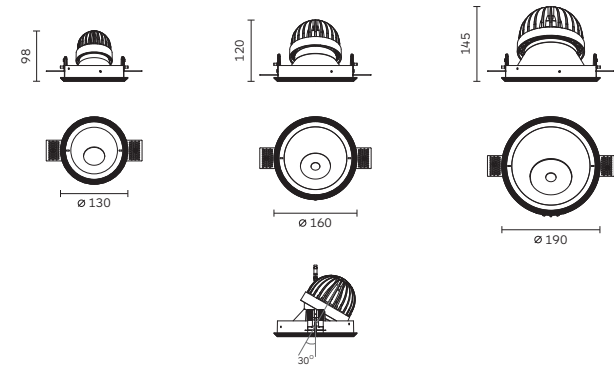
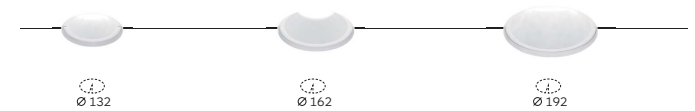
Code ordering example: **R F 1 4 B C 2 2 - 9 0 3 0 W W D 0 1 0**

	Product Code	Light Source Code*	>CRI	CCT**	LED Power	Nominal Lumen	Beam Angle (BA°)	Driver Options	Finish
Palla 70 Wallwasher Round	<b>RF14</b>	<b>BC22</b>	<b>90</b>	<b>30</b> 3000K	12W	1500 lm	<b>WW</b>	<b>D0</b> No Dim	<b>10</b> Black
	<b>RF15</b>			<b>40</b> 4000K		1520 lm		<b>DA</b> Dali Dim	<b>11</b> White
Palla 100 Wallwasher Round	<b>RF10</b>	<b>BC33</b>			21W	2200 lm		<b>DP</b> Phase Dim	
	<b>RF11</b>					2300 lm		<b>DC</b> CASAMBI	
Palla 130 Wallwasher Round	<b>RF06</b>	<b>BC33</b>			33W	3220 lm		<b>D1</b> 0-10V Dim	
	<b>RF07</b>					3300 lm			

## Notes:

- \* For complete code ordering information, please see page 377.
  - \*\* For other CCT options, please contact us.
- For related accessories, please see page 37.



# Palla

Designed by **Franco Mirezni** (Registered)

## In & Out



## Fixed



## Wallwasher



## Body

Square shape mounting trim in cast aluminium with brackets for trim installation on ceiling thickness max. 25 mm or trimless installation on ceiling thickness max. 30 mm.

Luminaire body in cast aluminium and (only for In&Out version) thermoplastic material. Transparent safety cover included. Available in three different sizes.

In&Out version tiltable vertically in two directions (0°-30° In, 0-60° Out) and rotatable horizontally 350°.

## Accessories

Honeycomb louvre.  
Snap System™ accessories available for SORAA SLC series with narrow beam angle.

## Finish

Powder coat in black and white colour.

## LED sources

Citizen CLU Series. Xicato Artist, Beauty and Designer Series. SORAA SLC Optical Light Engine.  
CRI: 90, 95, 98 | CCT: 2700K, 3000K, 4000K.  
Other CRI and CCT options, Tuneable White and DimToWarm versions available on request.

## Optic

Lens.  
Narrow, medium and wide beam angle available.

## Driver

Supplied with No-dimable remote driver.  
Dimming Options: 0-10V Dim, DALI, Phase, CASAMBI.

## Applications

These series of downlights is designed to deliver superior performance, maximum versatility with fast-easy installation and allow lamp aiming while the power is on.  
Application areas: retail, hotels, restaurants, offices, lobbies.

## Related Products

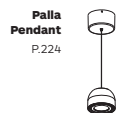
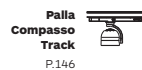

# Palla



## Palla 70 / 100 / 130

In & Out Square Trim

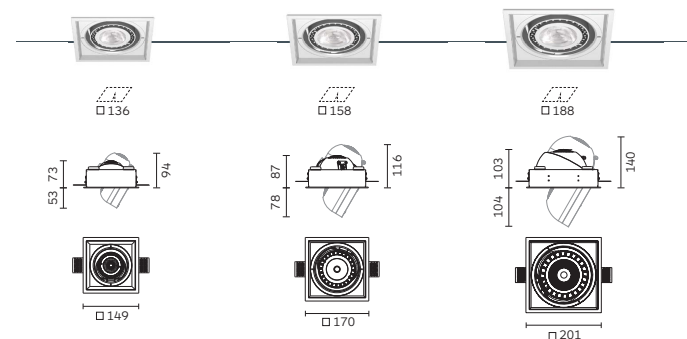

## Palla 70 / 100 / 130

In & Out Square Trimless

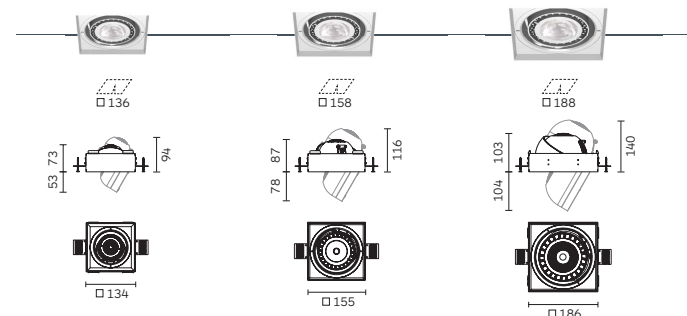

Code ordering example: **R N 7 2 B C 2 2 - 9 0 3 0 1 6 D 0 1 0**

	Product Code	Light Source Code*	>CRI	CCT**	LED Power	Nominal Lumen	Beam Angle (BA°)	Driver Options	Finish
Palla 70	<b>RN72</b> <input checked="" type="checkbox"/>	<b>BC22</b>	<b>90</b>	<b>30</b> 3000K	12W	1500 lm	<b>16 / 25 / 36</b>	<b>D0</b> No Dim	<b>10</b> <input checked="" type="checkbox"/> Black
In & Out Square	<b>RN73</b> <input type="checkbox"/>			<b>40</b> 4000K		1520 lm		<b>DA</b> Dali Dim	<b>11</b> <input type="checkbox"/> White
Palla 100	<b>RN74</b> <input checked="" type="checkbox"/>	<b>BC33</b>			21W	2200 lm	<b>15 / 24 / 38</b>	<b>DP</b> Phase Dim	
In & Out Square	<b>RN75</b> <input type="checkbox"/>					2300 lm		<b>DC</b> CASAMBI	
Palla 130	<b>RN76</b> <input checked="" type="checkbox"/>				33W	3220 lm	<b>12 / 22 / 32</b>	<b>D1</b> 0-10V Dim	
In & Out Square	<b>RN77</b> <input type="checkbox"/>					3300 lm			

## Notes:

\* For complete code ordering information, please see page 377.

\*\* For other CCT options, please contact us.

For related accessories, please see page 37.

For vertical tilt and horizontal rotation refer to the drawing of the round version (see page 29).

# Palla



**Palla 70 / 100 / 130**  
Fixed Square Trim

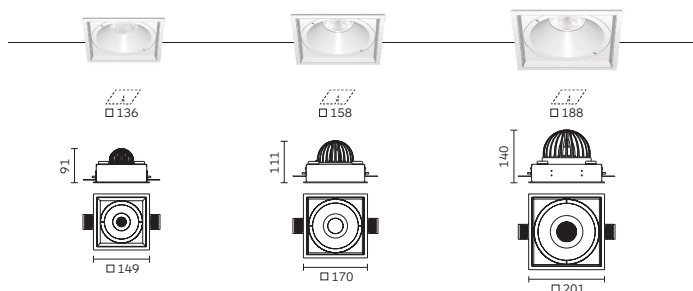

**Palla 70 / 100 / 130**  
Fixed Square Trimless

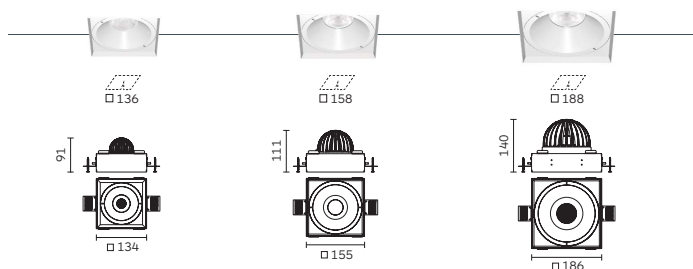

Code ordering example: **R N 9 4 B C 2 2 - 9 0 3 0 1 6 D 0 1 0**

	Product Code	Light Source Code*	>CRI	CCT**	LED Power	Nominal Lumen	Beam Angle (BA°)	Driver Options	Finish
Palla 70 Fixed Square	<b>RN94</b> <input checked="" type="checkbox"/>	<b>BC22</b>	<b>90</b>	<b>30</b> 3000K	12W	1500 lm	<b>16 / 25 / 36</b>	<b>D0</b> No Dim	<b>10</b> <input checked="" type="checkbox"/> Black
	<b>RN95</b> <input type="checkbox"/>			<b>40</b> 4000K		1520 lm		<b>DA</b> Dali Dim	<b>11</b> <input type="checkbox"/> White
Palla 100 Fixed Square	<b>RN98</b> <input checked="" type="checkbox"/>	<b>BC33</b>			21W	2200 lm	<b>15 / 24 / 38</b>	<b>DP</b> Phase Dim	
	<b>RN99</b> <input type="checkbox"/>					2300 lm		<b>DC</b> CASAMBI	
Palla 130 Fixed Square	<b>RO03</b> <input checked="" type="checkbox"/>	<b>BC33</b>			33W	3220 lm	<b>12 / 22 / 32</b>	<b>D1</b> 0-10V Dim	
	<b>RO04</b> <input type="checkbox"/>					3300 lm			

**Notes:**  
\* For complete code ordering information, please see page 377.  
\*\* For other CCT options, please contact us.  
For related accessories, please see page 37.

# Palla



**Palla 70 / 100 / 130**  
Wallwasher Square Trim

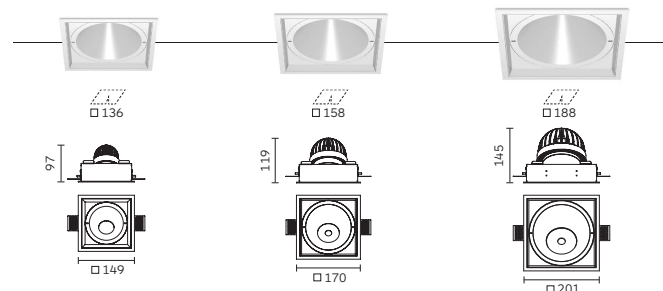

**Palla 70 / 100 / 130**  
Wallwasher Square Trimless

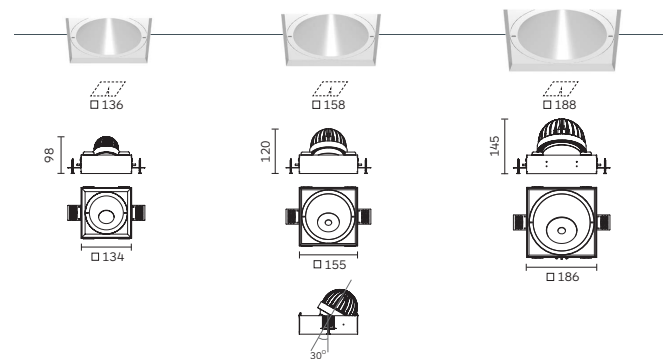

Code ordering example: **R I 4 1 B C 2 2 - 9 0 3 0 W W D 0 1 0**

	Product Code	Light Source Code*	>CRI	CCT**	LED Power	Nominal Lumen	Beam Angle (BA°)	Driver Options	Finish
Palla 70 Wallwasher Square	<b>RI41</b> <input checked="" type="checkbox"/>	<b>BC22</b>	<b>90</b>	<b>30</b> 3000K	12W	1500 lm	<b>WW</b>	<b>D0</b> No Dim	<b>10</b> <input checked="" type="checkbox"/> Black
	<b>RI47</b> <input type="checkbox"/>			<b>40</b> 4000K		1520 lm		<b>DA</b> Dali Dim	<b>11</b> <input type="checkbox"/> White
Palla 100 Wallwasher Square	<b>RI53</b> <input checked="" type="checkbox"/>	<b>BC33</b>			21W	2200 lm		<b>DP</b> Phase Dim	
	<b>RI59</b> <input type="checkbox"/>					2300 lm		<b>DC</b> CASAMBI	
Palla 130 Wallwasher Square	<b>RI65</b> <input checked="" type="checkbox"/>	<b>BC33</b>			33W	3220 lm		<b>D1</b> 0-10V Dim	
	<b>RI71</b> <input type="checkbox"/>					3300 lm			

**Notes:**  
\* For complete code ordering information, please see page 377.  
\*\* For other CCT options, please contact us.  
For related accessories, please see page 37.

## Palla Recessed Family configuration options

Code ordering example: R N 6 6 B C 2 2 - 9 0 3 0 1 6 D 0 1 0

### Palla 70 Round & Square

In & Out | Fixed | Wallwasher

Product Code	Light Source Code	>CRI	CCT	LED Power	Nominal Lumen	Beam Angle (BA°)	Driver Options	Finish
<b>RN66</b> <input checked="" type="radio"/> In & Out	<b>BC22</b> Citizen COB	<b>90</b>	<b>30</b> 3000K	12W	1500 lm	<b>16 / 25 / 36</b>	<b>D0</b> No Dim	<b>10</b> <input checked="" type="checkbox"/> Black
<b>RN67</b> <input type="radio"/> In & Out			<b>40</b> 4000K		1520 lm		<b>DA</b> Dali Dim	<b>11</b> <input type="checkbox"/> White
<b>RN72</b> <input checked="" type="checkbox"/> In & Out	<b>BS12</b> Soraa SLC-16	<b>95</b>		10W	500 lm	<b>10 / 25 / 36</b>	<b>DP</b> Phase Dim	
<b>RN73</b> <input type="checkbox"/> In & Out					525 lm		<b>DC</b> CASAMBI	
<b>RN84</b> <input checked="" type="radio"/> Fixed							<b>D1</b> 0-10V Dim	
<b>RN85</b> <input type="radio"/> Fixed								
<b>RN94</b> <input checked="" type="checkbox"/> Fixed								
<b>RN95</b> <input type="checkbox"/> Fixed								
<b>RF14</b> <input checked="" type="radio"/> Wallwasher								
<b>RF15</b> <input type="radio"/> Wallwasher								
<b>RI41</b> <input checked="" type="checkbox"/> Wallwasher								
<b>RI47</b> <input type="checkbox"/> Wallwasher								

### Palla 100 Round & Square

In & Out | Fixed | Wallwasher

Product Code	Light Source Code	>CRI	CCT	LED Power	Nominal Lumen	Beam Angle (BA°)	Driver Options	Finish
<b>RN68</b> <input checked="" type="radio"/> In & Out	<b>BC33</b> Citizen COB	<b>90</b>	<b>30</b> 3000K	21W	2200 lm	<b>15 / 24 / 38</b>	<b>D0</b> No Dim	<b>10</b> <input checked="" type="checkbox"/> Black
<b>RN69</b> <input type="radio"/> In & Out			<b>40</b> 4000K		2300 lm		<b>DA</b> Dali Dim	<b>11</b> <input type="checkbox"/> White
<b>RN74</b> <input checked="" type="checkbox"/> In & Out	<b>BS12</b> Soraa SLC-16	<b>95</b>		14W	800 lm	<b>10 / 25 / 36</b>	<b>DP</b> Phase Dim	
<b>RN75</b> <input type="checkbox"/> In & Out					850 lm		<b>DC</b> CASAMBI	
<b>RN88</b> <input checked="" type="radio"/> Fixed	<b>BX25</b> Xicato Artist XTM	<b>98</b>	<b>27</b> 2700K	13W	1400 lm	<b>16 / 28 / 38</b>	<b>D1</b> 0-10V Dim	
<b>RN89</b> <input type="radio"/> Fixed	<b>BX31</b> Beauty XTM	<b>95</b>		9.5W	931 lm			
<b>RN98</b> <input checked="" type="checkbox"/> Fixed	<b>BX41</b> Designer XTM	<b>90</b>		11.4W	1300 lm			
<b>RN99</b> <input type="checkbox"/> Fixed								
<b>RF10</b> <input checked="" type="radio"/> Wallwasher								
<b>RF11</b> <input type="radio"/> Wallwasher								
<b>RI53</b> <input checked="" type="checkbox"/> Wallwasher								
<b>RI59</b> <input type="checkbox"/> Wallwasher								

### Palla 130 Round & Square

In & Out | Fixed | Wallwasher

Product Code	Light Source Code	>CRI	CCT	LED Power	Nominal Lumen	Beam Angle (BA°)	Driver Options	Finish
<b>RN70</b> <input checked="" type="radio"/> In & Out	<b>BC33</b> Citizen COB	<b>90</b>	<b>30</b> 3000K	33W	3220 lm	<b>12 / 22 / 32</b>	<b>D0</b> No Dim	<b>10</b> <input checked="" type="checkbox"/> Black
<b>RN71</b> <input type="radio"/> In & Out			<b>40</b> 4000K		3300 lm		<b>DA</b> Dali Dim	<b>11</b> <input type="checkbox"/> White
<b>RN76</b> <input checked="" type="checkbox"/> In & Out	<b>BS22</b> SORAA SLE-30	<b>95</b>		20W	1200 lm	<b>09 / 25 / 36</b>	<b>DP</b> Phase Dim	
<b>RN77</b> <input type="checkbox"/> In & Out					1300 lm		<b>DC</b> CASAMBI	
<b>RN92</b> <input checked="" type="radio"/> Fixed	<b>BX25</b> XICATO Artist XTM	<b>98</b>	<b>27</b> 2700K	20W	2000 lm	<b>25 / 36 / 45</b>	<b>D1</b> 0-10V Dim	
<b>RN93</b> <input type="radio"/> Fixed	<b>BX32</b> Beauty XTM	<b>95</b>						
<b>RO03</b> <input checked="" type="checkbox"/> Fixed	<b>BX43</b> Designer XTM	<b>90</b>		25.7W	3000 lm			
<b>RO04</b> <input type="checkbox"/> Fixed								
<b>RF06</b> <input checked="" type="radio"/> Wallwasher								
<b>RF07</b> <input type="radio"/> Wallwasher								
<b>RI65</b> <input checked="" type="checkbox"/> Wallwasher								
<b>RI71</b> <input type="checkbox"/> Wallwasher								

#### Notes:

For other CCT options, please contact us.

## Optical Accessories

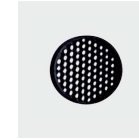

Product / Optical Accessories\* Honeycomb Louvre  
Colour 10

Palla 70 Recessed **2B95**

Palla 100 Recessed **2B99**

Palla 130 Recessed **2C04**

\* Optical accessories are not available for wallwasher version.  
For SORAA specific accessories, please contact us and we will provide the detailed information.

#### Notes:

\* Snoot accessory available upon request.

# Polaris

Designed by Franco Mirezzi (Registered)

## Fixed



## Adjustable



## Body

Square shape mounting trim in cast aluminium with springs for trim installation on ceiling thickness 2-25mm or brackets for trimless installation on ceiling thickness 2-25mm.

Luminaire body in cast aluminium with integrated diamond faceted screen made from thermoplastic and metalized polycarbonate reflector. Available in different configurations up to 16 light heads.

Light heads collectively tiltable in two directions from 0° to 35°.

## Accessories

No accessories available.

## Finish

Light body powder coat in black or white finish. Integrated louvre available in black or white finish.

## LED sources

Citizen CLU Series, Osram high power led  
CRI: 90 | CCT: 3000K, 4000K.  
Other CRI and CCT options, TuneableWhite version (30) available on request.

## Optic

Reflector. Medium and wide beam angle available.  
UGR<13 for a better visual comfort.

## Driver

Supplied with No-dimable remote driver.  
Dimming Options: 0-10V Dim, DALI, Phase, CASAMBI.

## Applications

An innovative solution for high brilliance and performance. The light source is barely visible, as the miniature light heads create a high contrast and circular light emission.  
Application areas: residential, hotels, restaurants, retail, corridors.

## Related Products

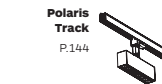

## Polaris 30



### Polaris 30

Fixed Trim

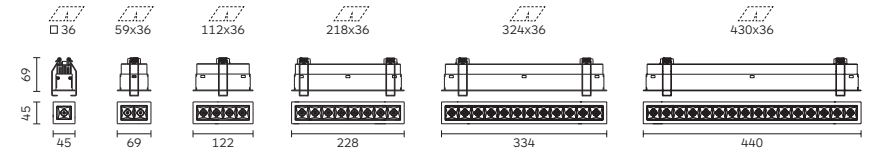

### Polaris 30

Fixed Trimless

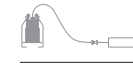
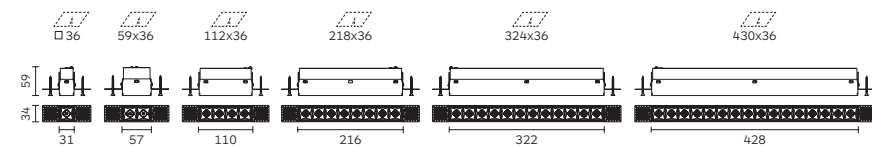

Code ordering example: **R J 3 4 B O 1 1 - 9 0 3 0 3 4 D 0 1 0**

	Product Code	Light Source Code*	>CRI	CCT**	LED Power	Nominal Lumen	Beam Angle (BA°)	Driver Options	Finish
Polaris 30	<b>RJ34</b> <input type="checkbox"/> x1	<b>BO11</b> Osram 3030	<b>90</b>	<b>30</b> 3000K	2W	190 lm	<b>34 / 50</b>	<b>D0</b> No Dim	<b>10</b> <input type="checkbox"/> Black
Fixed	<b>RJ35</b> <input type="checkbox"/>			<b>40</b> 4000K		240 lm		<b>DA</b> Dali Dim	<b>11</b> <input type="checkbox"/> White
	<b>RL83</b> <input type="checkbox"/> x2				2x2W	380 lm		<b>DP</b> Phase Dim	<b>17</b> <input type="checkbox"/> B/W
	<b>RL79</b> <input type="checkbox"/>					480 lm		<b>DC</b> CASAMBI	
	<b>RJ36</b> <input type="checkbox"/> x4				4x2W	760 lm		<b>D1</b> 0-10V Dim	
	<b>RJ37</b> <input type="checkbox"/>					960 lm			
	<b>RJ38</b> <input type="checkbox"/> x8				8x2W	1520 lm			
	<b>RJ39</b> <input type="checkbox"/>					1920 lm			
	<b>RJ40</b> <input type="checkbox"/> x12				12x2W	2280 lm			
	<b>RJ41</b> <input type="checkbox"/>					2880 lm			
	<b>RJ42</b> <input type="checkbox"/> x16				16x2W	3040 lm			
	<b>RJ43</b> <input type="checkbox"/>					3840 lm			

### Notes:

\* For complete code ordering information, please see page 377.

\*\* For other CCT options, please contact us.

IP65 version available on request.

**17:** White housing with black louvre. For black body with white integrated louvre consult us.

## Polaris 30



**Polaris 30**  
Adjustable Trim

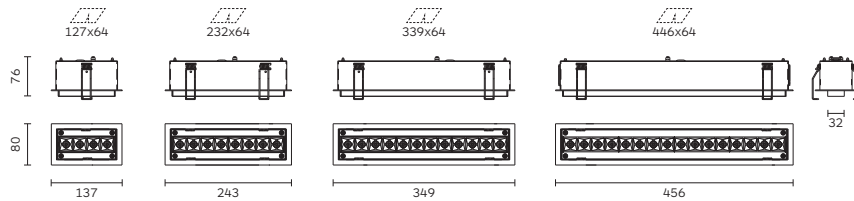

**Polaris 30**  
Adjustable Trimless

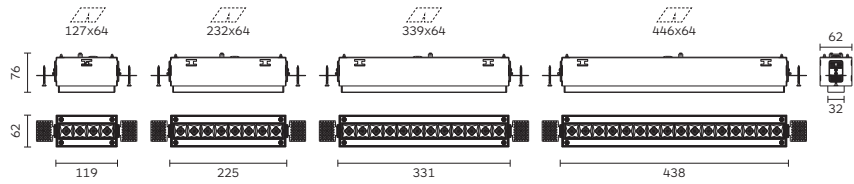
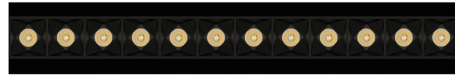

Code ordering example: **RL71 B011-90 30 34 D0 10**

	Product Code	Light Source Code*	>CRI	CCT**	LED Power	Nominal Lumen	Beam Angle (BA°)	Driver Options	Finish
Polaris 30 Adjustable	<b>RL71</b> <input checked="" type="checkbox"/> x4	<b>B011</b> Osram 3030	<b>90</b>	<b>30</b> 3000K	4x2W	760 lm	<b>34 / 50</b>	<b>D0</b> No Dim	<b>10</b> <input checked="" type="checkbox"/> Black
	<b>RL72</b> <input type="checkbox"/>			<b>40</b> 4000K		960 lm		<b>DA</b> Dali Dim	<b>11</b> <input type="checkbox"/> White
	<b>RL73</b> <input checked="" type="checkbox"/> x8				8x2W	1520 lm		<b>DP</b> Phase Dim	<b>17</b> <input checked="" type="checkbox"/> B/W
	<b>RL74</b> <input type="checkbox"/>					1920 lm		<b>DC</b> CASAMBI	
	<b>RL75</b> <input checked="" type="checkbox"/> x12				12x2W	2280 lm		<b>D1</b> 0-10V Dim	
	<b>RL76</b> <input type="checkbox"/>					2880 lm			
	<b>RL77</b> <input checked="" type="checkbox"/> x16				16x2W	3040 lm			
	<b>RL78</b> <input type="checkbox"/>					3840 lm			

### Notes:

\* For complete code ordering information, please see page 377.

\*\* For other CCT options, please contact us.

**17**: white light body with black integrated louvre. For black body with white integrated louvre consult us.

## Polaris 65



**Polaris 65**  
Fixed Trim

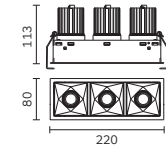
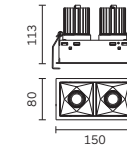
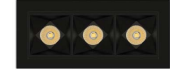

**Polaris 65**  
Fixed Trimless

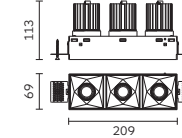
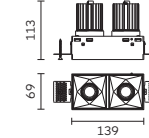
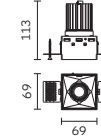
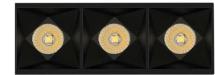
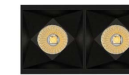

Code ordering example: **RJ44 BC22-90 30 30 D0 10**

	Product Code	Light Source Code*	>CRI	CCT**	LED Power	Nominal Lumen	Beam Angle (BA°)	Driver Options	Finish
Polaris 65 Fixed	<b>RJ44</b> <input checked="" type="checkbox"/> x1	<b>BC22</b> Citizen COB	<b>90</b>	<b>30</b> 3000K	12W	1495 lm	<b>30 / 53</b>	<b>D0</b> No Dim	<b>10</b> <input checked="" type="checkbox"/> Black
	<b>RJ45</b> <input type="checkbox"/>			<b>40</b> 4000K		1518 lm		<b>DA</b> Dali Dim	<b>11</b> <input type="checkbox"/> White
	<b>RJ46</b> <input checked="" type="checkbox"/> x2				2x12W	2990 lm		<b>DP</b> Phase Dim	<b>17</b> <input checked="" type="checkbox"/> B/W
	<b>RJ47</b> <input type="checkbox"/>					3036 lm		<b>DC</b> CASAMBI	
	<b>RJ48</b> <input checked="" type="checkbox"/> x3				3x12W	4485 lm		<b>D1</b> 0-10V Dim	
	<b>RJ49</b> <input type="checkbox"/>					4554 lm			

### Notes:

\* For complete code ordering information, please see page 377.

\*\* For other CCT options, please contact us.

**17**: white light body with black integrated louvre. For black body with white integrated louvre consult us.

# Polaris

Designed by **Franco Mirezzi** (Registered)



## Body

Square shape mounting trim in cast aluminium with springs for trim installation on ceiling thickness 2-25mm or brackets for trimless installation on ceiling thickness 2-25mm.

Luminaire body in cast aluminium with integrated layers of diffusers and reflectors made from thermoplastic and super pure aluminium.

## LED sources

Osram Oslon power led  
CRI: 90 | CCT: 3000K, 4000K.  
Other CRI and CCT options available on request.

## Optic

Set of PMMA lenses.

## Accessories

No accessories available.

## Finish

Light body powder coat in black or white finish. Integrated louvre available in black or white finish.

## Driver

Supplied with No-dimable remote driver.  
Dimming Options: 0-10V Dim, DALI, Phase, CASAMBI.

## Applications

High performance, linear wall washer with its layers special PMMA lenses, offers the possibility of extensive uniform wall-washing in open-plan spaces for general lighting applications.

Application areas: galleries, museums, commercial, hotels.

### Related Products

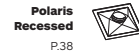

# Polaris

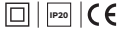

**Polaris 30**  
Wallwasher Trim

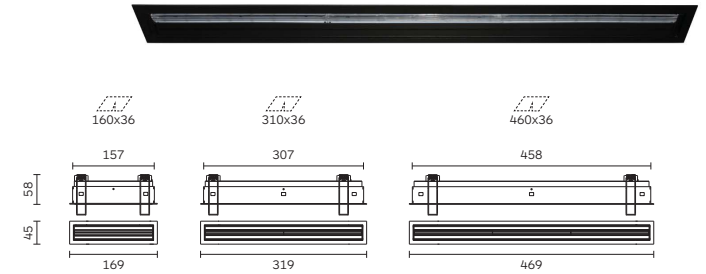

**Polaris 30**  
Wallwasher Trimless

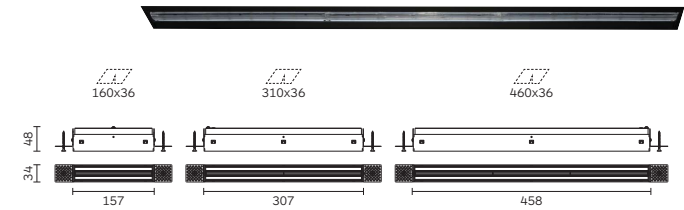

Code ordering example: **R L 6 5 B O 1 1 - 9 0 3 0 W W D 0 1 0**

	Product Code	Light Source Code*	>CRI	CCT**	LED Power	Nominal Lumen	Beam Angle (BA°)	Driver Options	Finish
Polaris 30 Wallwasher	<b>RL65</b> <input type="checkbox"/> x8	<b>BO11</b> Osram 3030	<b>90</b>	<b>30</b> 3000K	8x2W	1520 lm	<b>WW</b>	<b>D0</b> No Dim	<b>10</b> <input type="checkbox"/> Black
	<b>RL68</b> <input type="checkbox"/>			<b>40</b> 4000K		1920 lm		<b>DA</b> Dali Dim	<b>11</b> <input type="checkbox"/> White
	<b>RL66</b> <input type="checkbox"/> x16				16x2W	3040 lm		<b>DP</b> Phase Dim	<b>17</b> <input checked="" type="checkbox"/> B/W
	<b>RL69</b> <input type="checkbox"/>					3840 lm		<b>DC</b> CASAMBI	
	<b>RL67</b> <input type="checkbox"/> x24				24x2W	4560 lm		<b>D1</b> 0-10V Dim	
	<b>RL70</b> <input type="checkbox"/>					5760 lm			

### Notes:

\* For complete code ordering information, please see page 377.

\*\* For other CCT options, please contact us.

**17:** white light body with black integrated louvre. For black body with white integrated louvre consult us.

# Zoom

Designed by Ponctuelle



## Body

Square mounting trim in metal with springs/brackets for trim/trimless installation mounting on a ceiling thickness of 1-25mm.

Luminaire body and fully adjustable luminaire light-head in cast aluminium. Available in two sizes and with option of configurations of 1-2-3 light heads.

Created with pull out mechanism for height adjustment. Tilttable in all direction up to 45° and rotatable horizontally 350°.

## Accessories

Zoom 100: coloured filters, linear spread, honeycomb louvre, Visor and snoot.

## Finish

Powder coat in black, white or grey colour.

## LED sources

Citizen CLU Series (100), Cree single power led (50).  
CRI: 90 | CCT: 3000K, 4000K.  
Other CRI and CCT options available on request, Tuneable White and DimToWarm versions available on request only for Zoom 100.

## Optic

Lens. Super narrow, narrow, medium and wide beam angle available.

## Driver

Supplied with No-dimable remote driver.  
Dimming Options: 0-10V Dim, DALI, Phase, CASAMBI.

## Applications

An innovative solution of fully integrated adjustability allows to be extremely flexible for achieving different optic effects by hot aiming to the required direction.  
Application areas: retail, jewelry display, hotel restaurant, residential.

## Related Products

**Twist & Shout Recessed**

P48



**Iride Recessed**

P50



## Zoom 50



### Zoom 50

Adjustable Trim

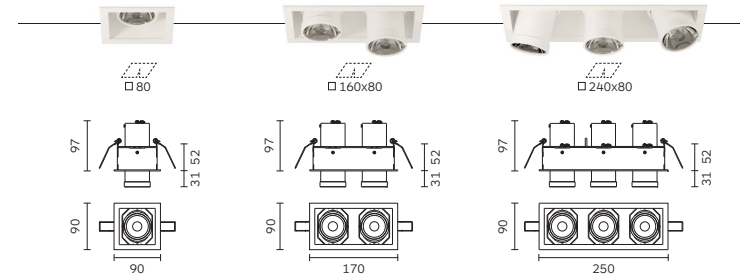

### Zoom 50

Adjustable Trimless

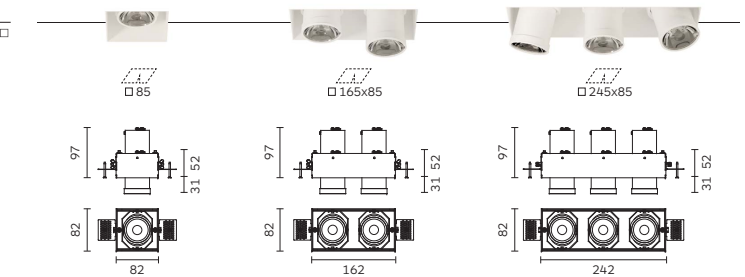

Code ordering example: **R H 8 7 B R 1 2 - 9 0 3 0 0 7 D 0 1 0**

	Product Code	Light Source Code*	>CRI	CCT**	LED Power	Nominal Lumen	Beam Angle (BA°)	Driver Options	Finish
Zoom 50 Adjustable	<b>RH87</b> <input checked="" type="checkbox"/> x1	<b>BR12</b>	<b>90</b>	<b>30</b> 3000K	4W	378 lm	<b>07</b>	<b>D0</b> No Dim	<b>10</b> <input checked="" type="checkbox"/> Black
	<b>RH90</b> <input type="checkbox"/>			<b>40</b> 4000K		463 lm		<b>DA</b> Dali Dim	<b>11</b> <input type="checkbox"/> White
	<b>RH88</b> <input checked="" type="checkbox"/> x2				2x4W	756 lm		<b>DP</b> Phase Dim	
	<b>RH91</b> <input type="checkbox"/>					926 lm		<b>DC</b> CASAMBI	
	<b>RH89</b> <input checked="" type="checkbox"/> x3				3x4W	1134 lm		<b>D1</b> 0-10V Dim	
	<b>RH92</b> <input type="checkbox"/>					1389 lm			

### Notes:

\* For complete code ordering information, please see page 377.

\*\* For other CCT options, please contact us.

For related accessories, please see page 47.

## Zoom 100

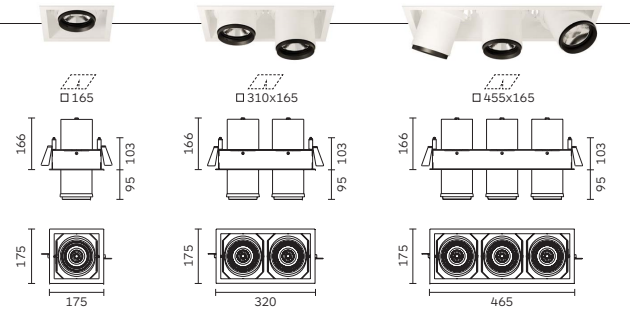

### Zoom 100

Adjustable Trim 

### Zoom 100

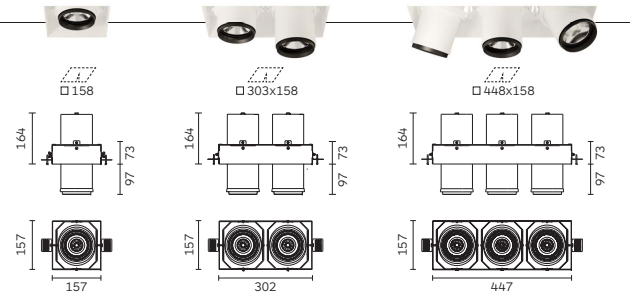
Adjustable Trimless Code ordering example: R J 5 4 B C 3 3 - 9 0 3 0 1 2 D 0 1 0

Product Code	Light Source Code*	>CRI	CCT**	LED Power	Nominal Lumen	Beam Angle (BA°)	Driver Options	Finish
Zoom 100 Adjustable	<b>RJ54</b> <input checked="" type="checkbox"/> x1	<b>BC33</b>	<b>90</b>	<b>30</b> 3000K	3544 lm	<b>12 / 27 / 55</b>	<b>D0</b> No Dim	<b>10</b> <input checked="" type="checkbox"/> Black
	<b>RJ55</b> <input type="checkbox"/>		<b>40</b> 4000K		3693 lm		<b>DA</b> Dali Dim	<b>11</b> <input type="checkbox"/> White
	<b>RJ56</b> <input checked="" type="checkbox"/> x2			2x39W	7088 lm		<b>DP</b> Phase Dim	
	<b>RJ57</b> <input type="checkbox"/>				7386 lm		<b>DC</b> CASAMBI	
	<b>RJ61</b> <input checked="" type="checkbox"/> x3			3x39W	10632 lm		<b>D1</b> 0-10V Dim	
	<b>RJ62</b> <input type="checkbox"/>				11079 lm			

#### Notes:

- \* For complete code ordering information, please see page 377.
- \*\* For other CCT options, please contact us.
- For related accessories, please see page 47.

## Zoom Recessed Family configuration options

Code ordering example: R H 8 7 B R 2 1 - 9 0 3 0 0 7 D 0 1 0

### Zoom 50

Adjustable

Product Code	Light Source Code	>CRI	CCT	LED Power	Nominal Lumen	Beam Angle (BA°)	Driver Options	Finish
<b>RH87</b> <input checked="" type="checkbox"/> x1	<b>BR12</b> CREE 3535	<b>90</b>	<b>30</b> 3000K	4W	378 lm	<b>07</b>	<b>D0</b> No Dim	<b>10</b> <input checked="" type="checkbox"/> Black
<b>RH90</b> <input type="checkbox"/>			<b>40</b> 4000K		463 lm		<b>DA</b> Dali Dim	<b>11</b> <input type="checkbox"/> White
<b>RH88</b> <input checked="" type="checkbox"/> x2				2x4W	756 lm		<b>DP</b> Phase Dim	
<b>RH91</b> <input type="checkbox"/>					926 lm		<b>DC</b> CASAMBI	
<b>RH89</b> <input checked="" type="checkbox"/> x3				3x4W	1134 lm		<b>D1</b> 0-10V Dim	
<b>RH92</b> <input type="checkbox"/>					1389 lm			
	<b>GUS3</b> Retrofit MR16-GU5.3	<b>00</b>	<b>00</b>	/	/	<b>00</b>	<b>DP</b> Phase Dim	

### Zoom 100

Adjustable

Product Code	Light Source Code	>CRI	CCT	LED Power	Nominal Lumen	Beam Angle (BA°)	Driver Options	Finish
<b>RJ54</b> <input checked="" type="checkbox"/> x1	<b>BC33</b> Citizen COB	<b>90</b>	<b>30</b> 3000K	39W	3544 lm	<b>12 / 27 / 55</b>	<b>D0</b> No Dim	<b>10</b> <input checked="" type="checkbox"/> Black
<b>RJ55</b> <input type="checkbox"/>			<b>40</b> 4000K		3693 lm		<b>DA</b> Dali Dim	<b>11</b> <input type="checkbox"/> White
<b>RJ56</b> <input checked="" type="checkbox"/> x2				2x39W	7088 lm		<b>DP</b> Phase Dim	
<b>RJ57</b> <input type="checkbox"/>					7386 lm		<b>DC</b> CASAMBI	
<b>RJ61</b> <input checked="" type="checkbox"/> x3				3x39W	10632 lm		<b>D1</b> 0-10V Dim	
<b>RJ62</b> <input type="checkbox"/>					11079 lm			

## Optical Accessories

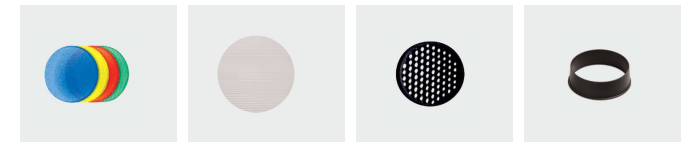

Product / Optical Accessories	Coloured Filters Colours 25, 42, 55, 85	Linear Spread Colour 41	Honeycomb Louvre Colour 10	Snoot Colours 10, 17
Zoom 100	<b>2A47*</b>	<b>2A50</b>	<b>2A53</b>	<b>2A59</b>

\* With holder

#### Notes:

For other CCT options, please contact us.



# Twist & Shout

Recessed Round & Square



## Body

Round or square mounting trim in cast aluminium with springs/brackets for trim installation mounting on a ceiling thickness of 1-25mm or brackets for trimless installation mounting on a ceiling thickness 12.5-15mm.

Luminaire body and fully adjustable luminaire light head in cast aluminium.

Pull out mechanism for height adjustment. Tiltable with up to 40° in all direction and rotatable horizontally 350°.

## Accessories

No accessories available.

## Finish

Powder coat in black, white or grey colour.

## LED sources

Cree single power led, Bridgelux Vero series.  
CRI: 90 | CCT: 3000K, 4000K.  
Other CRI and CCT options available on request.

## Optic

Lens. Super narrow, narrow, medium and wide beam angle available.

## Driver

Supplied with No-dimable remote driver.  
Dimming Options: 0-10V Dim, DALI, Phase, CASAMBI.

## Applications

A system concept that can be tilted and pulled in or out from the ceiling to direct the light beam in any direction to create the desired architectural composition.  
Application areas: residential, restaurants, hotels.

## Related Products



# Twist & Shout Round & Square



**Twist & Shout**  
Adjustable Trim

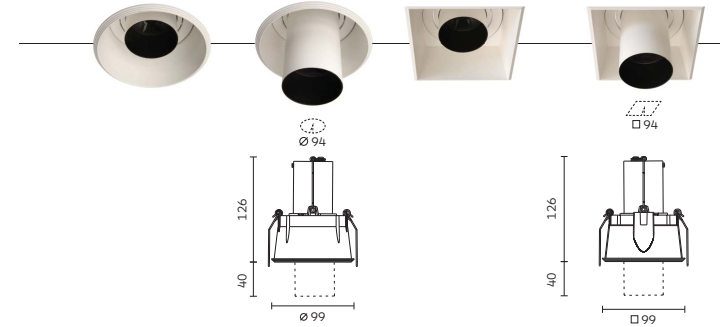

**Twist & Shout**  
Adjustable Trimless

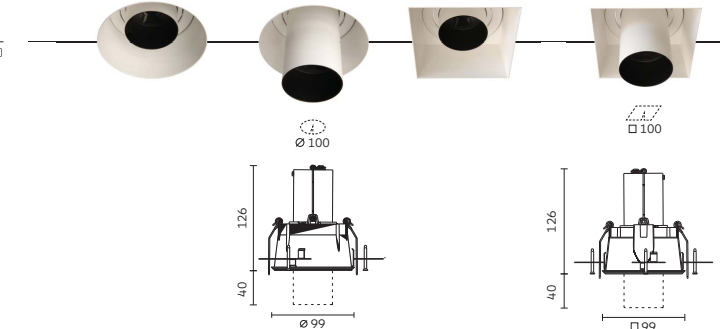

Code ordering example: **R K 6 5 B R 1 2 - 9 0 3 0 0 7 D 0 1 0**

	Product Code	Light Source Code*	>CRI	CCT**	LED Power	Nominal Lumen	Beam Angle (BA°)	Driver Options	Finish
Twist & Shout Adjustable Round	<b>RK65</b> <input checked="" type="checkbox"/>	<b>BR12</b> Osram 3535	<b>90</b>	<b>30</b>	3000K 4W	378 lm	<b>07</b>	<b>D0</b> No Dim	<b>10</b> <input checked="" type="checkbox"/> Black
	<b>RK66</b> <input type="checkbox"/>			<b>40</b>	4000K	463 lm		<b>DA</b> Dali Dim	<b>11</b> <input type="checkbox"/> White
Twist & Shout Adjustable Square	<b>RK67</b> <input checked="" type="checkbox"/>	<b>BB11</b> Bridgelux COB			10W	995 lm	<b>17 / 25 / 32</b>	<b>DP</b> Phase Dim	
	<b>RK68</b> <input type="checkbox"/>					1061 lm		<b>DC</b> CASAMBI	
								<b>D1</b> 0-10V Dim	

## Notes:

\* For complete code ordering information, please see page 377.

\*\* For other CCT options, please contact us.

# Iride

Designed by Walter Amort (Registered)



## Body

Round mounting trim in cast aluminum with springs for trim installation on a ceiling thickness of 1-25mm.

Luminaire body in cast aluminium and thermoplastic materials.

The fully retractable light head is tiltable with up to 35° (Iride 60) or 30° (Iride 85) and rotatable horizontally 350°.

## LED sources

Citizen CLU Series. Xicato Artist, Beauty and Designer Series.

CRI: 90, 95, 98 | CCT: 2700K, 3000K, 4000K.  
Other CRI and CCT options, Tuneable White and DimToWarm versions available on request.

## Optic

Reflector + diffuser.  
Narrow, medium and wide beam angle available.

## Accessories

Coloured filters, honeycomb louvre, linear spread.

## Finish

Powder coat in black, white or grey colour.

## Driver

Supplied with No-dimable remote driver.  
Dimming Options: 0-10V Dim, DALI, Phase, CASAMBI.

## Applications

Its unique pull-down mechanism enables it to function as either a downlight, a recessed accent light with great cut-off, a visible lamp able to emulate a surface or track fixture. Application areas: retail, museums, showrooms, window displays.

## Related Products



# Iride



## Iride 62 / 85

Adjustable Trim

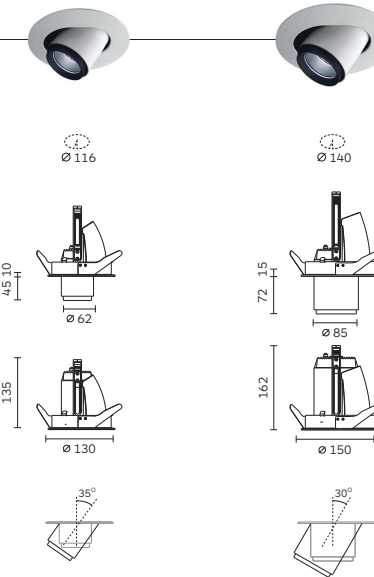

Code ordering example: **5 3 3 8 B C 2 2 - 9 0 3 0 1 8 D 0 1 0**

	Product Code	Light Source Code*	>CRI	CCT**	LED Power	Nominal Lumen	Beam Angle (BA°)	Driver Options	Finish
Iride 62	<b>5338</b>	<b>BC22</b>	<b>90</b>	<b>30</b> 3000K	18W	1790 lm	<b>18 / 26 / 39</b>	<b>D0</b> No Dim	<b>10</b> ■ Black
Adjustable				<b>40</b> 4000K		1850 lm		<b>DA</b> Dali Dim	<b>11</b> □ White
Iride 85	<b>5643</b>	<b>BC33</b>			33W	3000 lm	<b>13 / 26 / 39</b>	<b>DP</b> Phase Dim	
Adjustable						3130 lm		<b>DC</b> CASAMBI	
								<b>D1</b> 0-10V Dim	

## Notes:

\* For complete code ordering information, please see page 377.

\*\* For other CCT options, please contact us.



For related accessories, please see page 53.

## Iride Recessed Family configuration options

Code ordering example: 5 3 3 8 B C 2 2 - 9 0 3 0 1 8 D 0 1 0



### Iride 62

Adjustable

Product Code	Light Source Code	>CRI	CCT	LED Power	Nominal Lumen	Beam Angle (BA°)	Driver Options	Finish
<b>5338</b> 	<b>BC22</b> Citizen COB	<b>90</b>	<b>30</b> 3000K	18W	1790 lm	<b>18 / 26 / 39</b>	<b>D0</b> No Dim	<b>10</b>  Black
			<b>40</b> 4000K		1850 lm		<b>DA</b> Dali Dim	
	<b>BX25</b> Xicato Artist XTM	<b>98</b>	<b>27</b> 2700K	20W	2000 lm	<b>30 / 42 / 55</b>	<b>DP</b> Phase Dim	
<b>BX32</b> Beauty XTM	<b>95</b>		20W	2000 lm	<b>DC</b> CASAMBI		<b>D1</b> 0-10V Dim	

### Iride 85

Adjustable

Product Code	Light Source Code	>CRI	CCT	LED Power	Nominal Lumen	Beam Angle (BA°)	Driver Options	Finish
<b>5643</b> 	<b>BC33</b> Citizen COB	<b>90</b>	<b>30</b> 3000K	33W	3000 lm	<b>13 / 26 / 39</b>	<b>D0</b> No Dim	<b>10</b>  Black
			<b>40</b> 4000K		3130 lm		<b>DA</b> Dali Dim	
	<b>BX26</b> Xicato Artist XTM	<b>98</b>	<b>27</b> 2700K	30.5W	3000 lm	<b>20 / 40 / 60</b>	<b>DP</b> Phase Dim	
<b>BX43</b> Designer XTM	<b>95</b>		25.7W		<b>DC</b> CASAMBI		<b>D1</b> 0-10V Dim	

#### Notes:

For other CCT options, please contact us.

## Optical Accessories

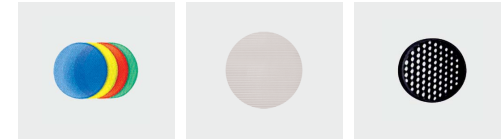

Product / Optical Accessories	Coloured Filters Colours 25, 42, 55, 85	Linear Spread Colour 41	Honeycomb Louvre Colour 10
Iride 62	<b>2C46*</b>	<b>2C45</b>	<b>2065</b>
Iride 85	<b>2B87*</b>	<b>2B88</b>	<b>2633</b>

\* With holder

# Eclisse Pro

Recessed 110 | 155 | 195

Fixed / Adjustable



## Body

Round mounting trim in cast aluminium with springs for trim installation on a ceiling thickness of max. 30mm or brackets for trimless installation on a ceiling thickness of 12-15mm.

Luminaire body and front ring in cast aluminium with integrated superpure aluminium reflector.

Adjustable version tiltable vertically 0-35° and rotatable horizontally 350°.

## LED sources

Bridgelux Vero Series, Citizen CLU Series, Xicato Artist, Beauty and Designer Series.  
CRI: 90, 95, 98 | CCT: 2700K, 3000K, 4000K.  
Other CRI and CCT options, Tuneable White and DimToWarm versions available on request.

## Optic

Inner reflector & secondary reflector.  
Narrow, medium and wide beam angle available.

## Related Products



## Accessories

No accessories available.

## Finish

Powder coat in white or grey colour.

## Driver

Supplied with No-dimable remote driver.  
Dimming Options: 0-10V Dim, DALI, Phase, CASAMBI.

## Applications

A visual simplicity seamless shape designed for excellent visual comfort with full directional light adjustability keeping homogeneous appearance. Ideal for highlighting.  
Application areas: retail, hotels, restaurants, gyms.

# Eclisse Pro



## Eclisse Pro 110 / 155 / 195

Fixed Trim

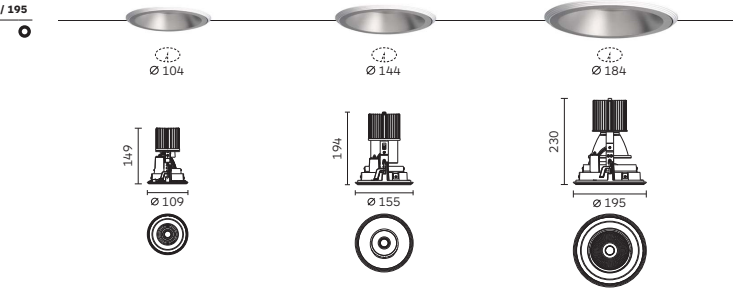

## Eclisse Pro 110 / 155 / 195

Fixed Trimless

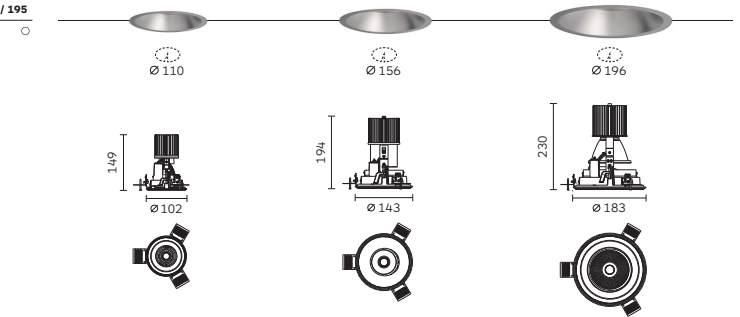

Code ordering example: **R J 9 1 B C 2 2 - 9 0 3 0 1 6 D 0 1 1**

	Product Code	Light Source Code*	>CRI	CCT**	LED Power	Nominal Lumen	Beam Angle (BA°)	Driver Options	Finish
Eclisse Pro 110 Fixed	<b>RJ91</b> <input checked="" type="radio"/>	<b>BC22</b>	<b>90</b>	<b>30</b> 3000K	18W	1800 lm	<b>16 / 27 / 40</b>	<b>D0</b> No Dim	<b>11</b> <input type="checkbox"/> White
	<b>RJ92</b> <input type="radio"/>			<b>40</b> 4000K		1900 lm		<b>DA</b> Dali Dim	<b>75</b> <input type="checkbox"/> Grey
Eclisse Pro 155 Fixed	<b>RF94</b> <input checked="" type="radio"/>	<b>BB12</b>			26W	2030 lm	<b>14 / 27 / 40</b>	<b>DP</b> Phase Dim	
	<b>RG01</b> <input type="radio"/>					2190 lm		<b>DC</b> CASAMBI	
Eclisse Pro 195 Fixed	<b>RF80</b> <input checked="" type="radio"/>	<b>BB11</b>			44W	3500 lm	<b>16 / 29 / 38</b>	<b>D1</b> 0-10V Dim	
	<b>RF88</b> <input type="radio"/>					4000 lm			

## Notes:

\* For complete code ordering information, please see page 377.

\*\* For other CCT options, please contact us.

## Eclipse Pro



### Eclipse Pro 110 / 155 / 195

Adjustable Trim

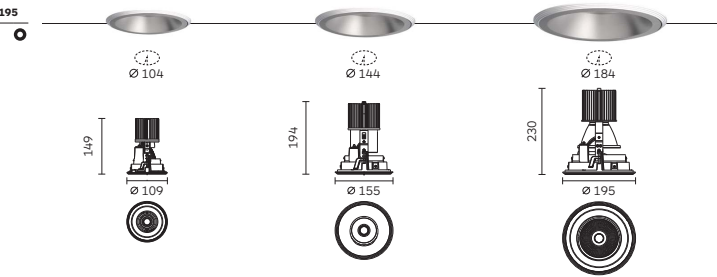

### Eclipse Pro 110 / 155 / 195

Adjustable Trimless

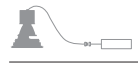
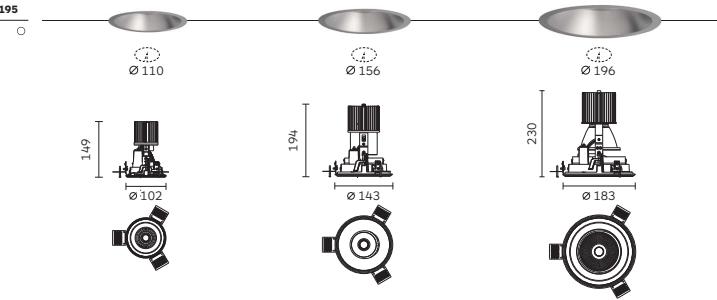
Code ordering example: **R C 4 7 B C 2 2 - 9 0 3 0 1 6 D 0 1 1**

	Product Code	Light Source Code*	>CRI	CCT**	LED Power	Nominal Lumen	Beam Angle (BA°)	Driver Options	Finish
Eclipse Pro 110 Adjustable	<b>RC47</b> <input checked="" type="radio"/>	<b>BC22</b>	<b>90</b>	<b>30</b> 3000K	18W	1800 lm	<b>16 / 27 / 40</b>	<b>D0</b> No Dim	<b>11</b> <input type="checkbox"/> White
	<b>RC48</b> <input type="radio"/>		<b>40</b>	4000K		1900 lm		<b>DA</b> Dali Dim	<b>75</b> <input type="checkbox"/> Grey
Eclipse Pro 155 Adjustable	<b>RC45</b> <input checked="" type="radio"/>	<b>BB12</b>			26W	2030 lm	<b>14 / 27 / 40</b>	<b>DP</b> Phase Dim	
	<b>RC46</b> <input type="radio"/>					2190 lm		<b>DC</b> CASAMBI	
Eclipse Pro 195 Adjustable	<b>RC43</b> <input checked="" type="radio"/>	<b>BB11</b>			44W	3500 lm	<b>16 / 29 / 38</b>	<b>D1</b> 0-10V Dim	
	<b>RC44</b> <input type="radio"/>					4000 lm			

#### Notes:

\* For complete code ordering information, please see page 377.

\*\* For other CCT options, please contact us.

## Eclipse Pro Recessed Family configuration options

Code ordering example: **R J 9 1 B C 2 2 - 9 0 3 0 1 6 D 0 1 1**

### Eclipse Pro 110

Fixed | Adjustable

Product Code	Light Source Code	>CRI	CCT	LED Power	Nominal Lumen	Beam Angle (BA°)	Driver Options	Finish
<b>RJ91</b> <input checked="" type="radio"/> Fixed	<b>BC22</b> Citizen COB	<b>90</b>	<b>30</b> 3000K	18W	1800 lm	<b>16 / 27 / 40</b>	<b>D0</b> No Dim	<b>11</b> <input type="checkbox"/> White
<b>RJ92</b> <input type="radio"/> Fixed		<b>40</b>	4000K		1900 lm		<b>DA</b> Dali Dim	<b>75</b> <input type="checkbox"/> Grey
<b>RC47</b> <input checked="" type="radio"/> Adjustable	<b>BX22</b> Xicato Artist XTM	<b>98</b>	<b>27</b> 2700K	10.6W	700 lm	<b>22 / 38 / 48</b>	<b>DP</b> Phase Dim	
<b>RC48</b> <input type="radio"/> Adjustable	<b>BX61</b>			11.5W			<b>DC</b> CASAMBI	
	<b>BX31</b> Beauty XTM	<b>95</b>		9.5W	931 lm	<b>28 / 35 / 45</b>	<b>D1</b> 1-10V Dim	
	<b>BX71</b>			11.5W				
	<b>BX41</b> Designer XTM	<b>90</b>		11.4W	1300 lm			
	<b>BX81</b>			13.2W				
<b>GU53</b> Retrofit	MR16-GU5.3	<b>00</b>	<b>00</b>	/	/	<b>00</b>	<b>00</b> No Driver	
<b>GU10</b>	GZ10-GU10							

### Eclipse Pro 155

Fixed | Adjustable

Product Code	Light Source Code	>CRI	CCT	LED Power	Nominal Lumen	Beam Angle (BA°)	Driver Options	Finish
<b>RF94</b> <input checked="" type="radio"/> Fixed	<b>BB12</b> Bridgelux COB	<b>90</b>	<b>30</b> 3000K	26W	2030 lm	<b>14 / 27 / 40</b>	<b>D0</b> No Dim	<b>11</b> <input type="checkbox"/> White
<b>RG01</b> <input type="radio"/> Fixed		<b>40</b>	4000K		2190 lm		<b>DA</b> Dali Dim	<b>75</b> <input type="checkbox"/> Grey
<b>RC45</b> <input checked="" type="radio"/> Adjustable	<b>BX22</b> Xicato Artist XTM	<b>98</b>	<b>27</b> 2700K	10.6W	700 lm	<b>22 / 38 / 48</b>	<b>DP</b> Phase Dim	
<b>RC46</b> <input type="radio"/> Adjustable	<b>BX61</b>			11.5W			<b>DC</b> CASAMBI	
	<b>BX31</b> Beauty XTM	<b>95</b>		9.5W	931 lm	<b>28 / 35 / 45</b>	<b>D1</b> 0-10V Dim	
	<b>BX71</b>			11.5W				
	<b>BX41</b> Designer XTM	<b>90</b>		11.4W	1300 lm			
	<b>BX81</b>			13.2W				

### Eclipse Pro 195

Fixed | Adjustable

Product Code	Light Source Code	>CRI	CCT	LED Power	Nominal Lumen	Beam Angle (BA°)	Driver Options	Finish
<b>RF80</b> <input checked="" type="radio"/> Fixed	<b>BB11</b> Bridgelux COB	<b>90</b>	<b>30</b> 3000K	44W	3500 lm	<b>16 / 29 / 38</b>	<b>D0</b> No Dim	<b>11</b> <input type="checkbox"/> White
<b>RF88</b> <input type="radio"/> Fixed		<b>40</b>	4000K		4000 lm		<b>DA</b> Dali Dim	<b>75</b> <input type="checkbox"/> Grey
<b>RC43</b> <input checked="" type="radio"/> Adjustable							<b>DP</b> Phase Dim	
<b>RC44</b> <input type="radio"/> Adjustable							<b>DC</b> CASAMBI	
							<b>D1</b> 0-10V Dim	
<b>AR11</b> Retrofit	AR111	<b>00</b>	<b>00</b>	/	/	<b>00</b>	<b>00</b> No Driver	

#### Notes:

For other CCT options, please contact us.

# Piazza LED

Designed by Franco Mirezzi (Registered)

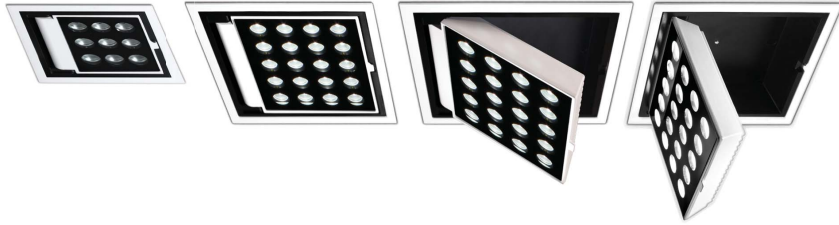

## Body

Square mounting trim in cast aluminium with brackets for trim/trimless installation on a ceiling thickness of 12.5-25mm.

Light head made of cast aluminium and thermoplastic materials with Safety glass and safety cable included. Available in two sizes.

Pivot out mechanism tiltable up to 90°.

## LED sources

Cree Powered.  
CRI: 90 | CCT: 3000K, 4000K, TuneableWhite.  
Other CRI and CCT options available on request.

## Optic

Lens.  
Narrow, medium and wide beam angle available.

## Accessories

No accessories available.

## Finish

Powder coat in black or white colour.

## Driver

Supplied with No-dimable remote driver.  
Dimming Options: 0-10V Dim, DALI, Phase, CASAMBI.

## Applications

A wall washing lighting with the ability to provide effective illumination for display of merchandise. The TuneableWhite version help to optimize the colour of illuminated object.  
Application areas: retail, galleries, hospitality, residential, lobbies.

## Related Products

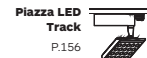

# Piazza LED



**Piazza LED 82 / 144**  
Adjustable Trim

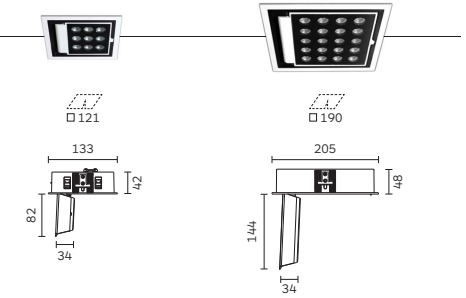

**Piazza LED 82 / 144**  
Adjustable Trimless

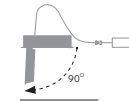
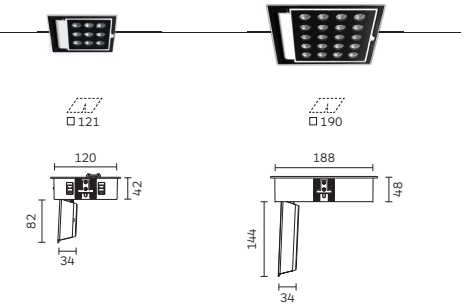

Code ordering example: **R D 5 4 B R 1 1 - 9 0 3 0 1 0 D 0 1 0**

	Product Code	Light Source Code*	>CRI	CCT**	LED Power	Nominal Lumen	Beam Angle (BA°)	Driver Options	Finish
Piazza LED 82 Adjustable	<b>RD54</b> <input checked="" type="checkbox"/>	<b>BR11</b> Cree 3535	<b>90</b>	<b>30</b> 3000K	12W	1393 lm	<b>10/23/46/WW</b>	<b>D0</b> No Dim	<b>10</b> <input checked="" type="checkbox"/> Black
	<b>RD98</b> <input type="checkbox"/>			<b>40</b> 4000K		1502 lm		<b>DA</b> Dali Dim	<b>11</b> <input type="checkbox"/> White
				<b>TW</b> 1800K - 6000K		/		<b>DP</b> Phase Dim	
Piazza LED 144 Adjustable	<b>RD53</b> <input checked="" type="checkbox"/>			<b>30</b> 3000K	40W	4108 lm		<b>DC</b> CASAMBI	
	<b>RD97</b> <input type="checkbox"/>			<b>40</b> 4000K		4396 lm		<b>D1</b> 0-10V Dim	
				<b>TW</b> 1800K - 6000K		/			

## Notes:

\* For complete code ordering information, please see page 377.

\*\* For other CCT options, please contact us.

# Girofix / MultiGiro / MultiQuadro

Recessed



## Body

Round or Square mounting trim in cast aluminium with spring for installation mounting on a ceiling thickness of 1-25mm.

Luminaire body in cast aluminum. Easy relamping tool-free via removable lamp front ring. Available in two different sizes.

Adjustable version (MultiGiro, MultiQuadro) tiltable vertically 0-40° and rotatable horizontally 350°.

## Accessories

Honeycomb louvre, anti-glare cone. Snap System™ accessories available for SORAA SLE series with narrow beam angle.

## Finish

Powder coat in black, white or grey colour.

## LED sources

Citizen CLU Series. Xicato Artist, Beauty and Designer Series. SORAA SLE Optical Light Engine. CRI: 90, 95, 98 | CCT: 2700K, 3000K, 4000K. Other CRI and CCT options, Tuneable White and Dim-ToWarm versions available on request.

## Optic

Lens. Narrow, medium and wide beam angle available.

## Driver

Supplied with No-dimable remote driver. COB version Dimming Options: 0-10V Dim, DALI, Phase, CASAMBI.

## Applications

A fully adjustable light head designed to accommodate any recessed lighting application and allow lamp aiming while power is on. Application areas: retail, shopping centers, corridors, window display.

## Related Products



## Girofix



**Girofix 57 / 80**  
Fixed

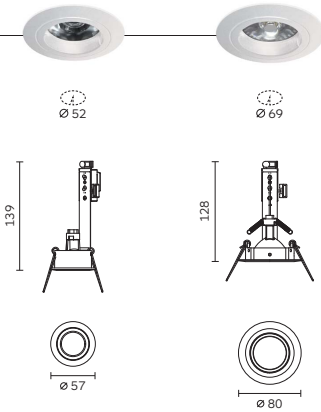

Code ordering example: **5 0 8 5 G U 0 4 - 0 0 0 0 0 0 1 0**

	Product Code	Light Source Code*	>CRI	CCT**	LED Power	Nominal Lumen	Beam Angle (BA°)	Driver Options	Finish
Girofix 57 Fixed	<b>5085</b>	<b>GU04</b>	<b>00</b>	<b>00</b>	/	/	<b>00</b>	<b>00</b> No Driver	<b>10</b> ■ Black <b>11</b> □ White <b>75</b> ■ Grey
Girofix 80 Fixed	<b>5086</b>	<b>GU53</b>							

## Notes:

\* For complete code ordering information, please see page 377.

\*\* For other CCT options, please contact us.

## MultiGiro



## MultiGiro 75 / 89

Adjustable

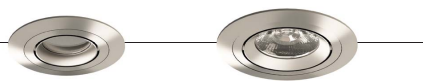
  
Ø 66

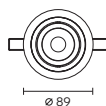
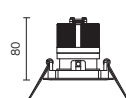
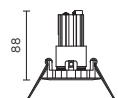
  
Ø 82
Code ordering example: **R N 4 5 M C 3 1 - 9 0 3 0 2 0 D 0 1 0**

	Product Code	Light Source Code*	>CRI	CCT**	LED Power	Nominal Lumen	Beam Angle (BA°)	Driver Options	Finish
MultiGiro 75 Adjustable	<b>RN45</b> <b>MC31</b>		<b>90</b>	<b>30</b> 3000K	6W	616 lm	<b>20 / 30 / 40</b>	<b>D0</b> No Dim	<b>10</b> Black
				<b>40</b> 4000K		643 lm		<b>DA</b> Dali Dim	<b>11</b> White
MultiGiro 89 Adjustable	<b>RN41</b> <b>MC22</b>				10W	1276 lm	<b>18 / 24 / 36</b>	<b>DP</b> Phase Dim	<b>75</b> Grey
						1296 lm		<b>DC</b> CASAMBI	
								<b>D1</b> 0-10V Dim	

## Notes:

\* For complete code ordering information, please see page 377.

\*\* For other CCT options, please contact us.

For related accessories, please see page 65.

## MultiQuadro



## MultiQuadro 75 / 89

Adjustable

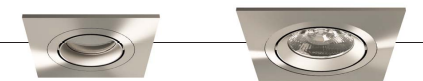
  
□ 66

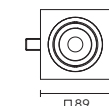
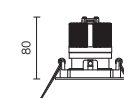
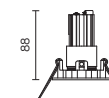
  
□ 82
Code ordering example: **R N 4 6 M C 3 1 - 9 0 3 0 2 0 D 0 1 0**

	Product Code	Light Source Code*	>CRI	CCT**	LED Power	Nominal Lumen	Beam Angle (BA°)	Driver Options	Finish
MultiQuadro 75 Adjustable	<b>RN46</b> <b>MC31</b>		<b>90</b>	<b>30</b> 3000K	6W	616 lm	<b>20 / 30 / 40</b>	<b>D0</b> No Dim	<b>10</b> Black
				<b>40</b> 4000K		643 lm		<b>DA</b> Dali Dim	<b>11</b> White
MultiQuadro 89 Adjustable	<b>RN42</b> <b>MC22</b>				10W	1276 lm	<b>18 / 24 / 36</b>	<b>DP</b> Phase Dim	<b>75</b> Grey
						1296 lm		<b>DC</b> CASAMBI	
								<b>D1</b> 0-10V Dim	

## Notes:

\* For complete code ordering information, please see page 377.

\*\* For other CCT options, please contact us.

For related accessories, please see page 65.



## Girofix/MultiGiro/MultiQuadro Recessed Family configuration options

Code ordering example: R N 4 5 M C 3 1 - 9 0 3 0 2 0 D 0 1 0

### Girofix 57 / MultiGiro 75 / MultiQuadro 75

Fixed / Adjustable

Product Code	Light Source Code	>CRI	CCT	LED Power	Nominal Lumen	Beam Angle (BA°)	Driver Options	Finish
<b>RN45</b> <input checked="" type="radio"/> MultiGiro 75 Adjustable	<b>MC31</b> Citizen COB	<b>90</b>	<b>30</b> 3000K	6W	616 lm	<b>20 / 30 / 40</b>	<b>D0</b> No Dim	<b>10</b> <input checked="" type="checkbox"/> Black
<b>RN46</b> <input type="checkbox"/> MultiQuadro 75 Adjustable			<b>40</b> 4000K		643 lm		<b>DA</b> Dali Dim	<b>11</b> <input type="checkbox"/> White
							<b>DP</b> Phase Dim	<b>75</b> <input type="checkbox"/> Grey
							<b>DC</b> CASAMBI	
							<b>D1</b> 0-10V Dim	
<b>5085</b> <input checked="" type="radio"/> Girofix 57 Fixed	<b>GU04</b> Retrofit MR11-GU4	<b>00</b>	<b>00</b>	/	/	<b>00</b>	<b>00</b> No Driver	
<b>RN45</b> <input checked="" type="radio"/> MultiGiro 75 Adjustable								
<b>RN46</b> <input type="checkbox"/> MultiQuadro 75 Adjustable								

### Girofix 80 / MultiGiro 89 / MultiQuadro 89

Fixed / Adjustable

Product Code	Light Source Code	>CRI	CCT	LED Power	Nominal Lumen	Beam Angle (BA°)	Driver Options	Finish
<b>RN41</b> <input checked="" type="radio"/> MultiGiro 89 Adjustable	<b>MC22</b> Citizen COB	<b>90</b>	<b>30</b> 3000K	10W	1276 lm	<b>18 / 24 / 36</b>	<b>D0</b> No Dim	<b>10</b> <input checked="" type="checkbox"/> Black
<b>RN42</b> <input type="checkbox"/> MultiQuadro 89 Adjustable			<b>40</b> 4000K		1296 lm		<b>DA</b> Dali Dim	<b>11</b> <input type="checkbox"/> White
	<b>MS11</b> Soraa SLE-16	<b>95</b>		8.1W	460 lm	<b>10</b>	<b>DP</b> Phase Dim	<b>75</b> <input type="checkbox"/> Grey
					480 lm		<b>DC</b> CASAMBI	
					12.2W	<b>15 / 25 / 36</b>	<b>D1</b> 0-10V Dim	
					720 lm			
					755 lm			
	<b>MX22</b> Xicato Artist XTM	<b>98</b>	<b>27</b> 2700K	10.6W	700 lm	<b>16 / 28 / 38</b>		
	<b>MX61</b> XIM			11.5W				
	<b>MX31</b> Beauty XTM	<b>95</b>		9.5W	931 lm	<b>28 / 35 / 45</b>		
	<b>MX71</b> XIM			11.5W				
	<b>MX41</b> Designer XTM	<b>90</b>		11.4W	1300 lm			
	<b>MX81</b> XIM			13.2W				
<b>5086</b> <input checked="" type="radio"/> Girofix 80 Fixed	<b>GU10</b> Retrofit GU10/GZ10	<b>00</b>	<b>00</b>	/	/	<b>00</b>	<b>00</b> No Driver	
<b>RN41</b> <input checked="" type="radio"/> MultiGiro 89 Adjustable	<b>GU53</b> Retrofit MR16-GU5.3							
<b>RN42</b> <input type="checkbox"/> MultiQuadro 89 Adjustable								

#### Notes:

For other CCT options, please contact us.

## Optical Accessories

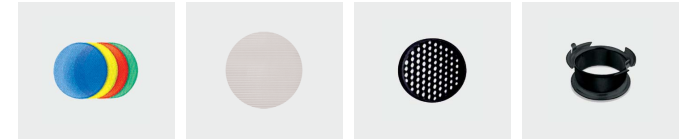

Product / Optical Accessories	Coloured Filters Colours 25, 42, 55, 85	Linear Spread Colour 41	Honeycomb Louvre Colour 10	Anti-glare Cone Colour 10
MultiGiro 89	<b>2C46*</b>	<b>2C45</b>	<b>2065</b>	<b>2661</b>
MultiQuadro 89	<b>2C46*</b>	<b>2C45</b>	<b>2065</b>	<b>2661</b>

\* With holder

For Soraa specific accessories, please contact us and we will provide the detailed information.

# MultiGiro Deep & MultiQuadro Deep

Recessed

## MultiGiro Deep



## MultiQuadro Deep



## Body

Round or Square mounting trim in cast aluminium with springs for trim installation mounting on a ceiling thickness of 1-25mm or brackets for trimless installation mounting on a ceiling thickness 12.5-15mm.

Luminaire body in cast aluminium. Easy relamping tool-free via removable lamp front ring. Available with configuration up to 2 light heads.

Tiltable vertically in two directions 0-25° and rotatable horizontally 350°.

## Accessories

Coloured filters, Honeycomb louvre, anti-glare cone, anti-glare hood. Snap System™ accessories available for SORAA SLE series with narrow beam angle.

## Finish

Powder coat in black, white or grey colour.

## LED sources

Citizen CLU Series. Xicato Artist, Beauty and Designer Series. SORAA SLE Optical Light Engine. CRI: 90, 95, 98 | CCT: 2700K, 3000K, 4000K. Other CRI and CCT options, Tuneable White and DimToWarm versions available on request.

## Optic

Lens. Narrow, medium and wide beam angle available.

## Driver

Supplied with No-dimable remote driver. Dimming Options: 0-10V Dim, DALI, Phase, CASAMBI.

## Applications

A fully adjustable light head designed to accommodate any recessed lighting application and allow lamp aiming while power is on. Application areas: retail, shopping centers, corridors, window display.

## Related Products

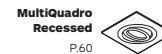

## MultiGiro Deep



### MultiGiro Deep

Adjustable Round Trim

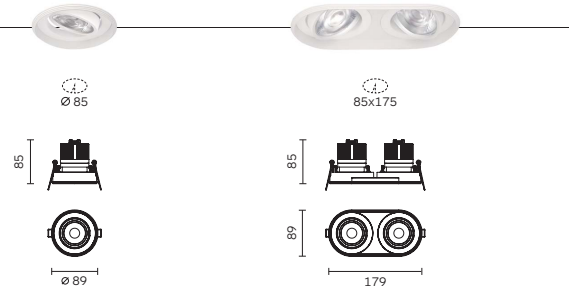

### MultiGiro Deep

Adjustable Round Trimless

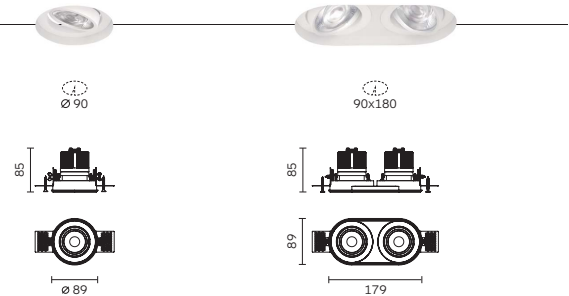

Code ordering example: **RG96MC22-903018D010**

	Product Code	Light Source Code*	>CRI	CCT**	LED Power	Nominal Lumen	Beam Angle (BA°)	Driver Options	Finish
MultiGiro Deep Adjustable Round	<b>RG96</b> x1	<b>MC22</b>	<b>90</b>	<b>30</b> 3000K	10W	1276 lm	<b>18 / 24 / 36</b>	<b>D0</b> No Dim	<b>10</b> Black
	<b>RG97</b>			<b>40</b> 4000K		1296 lm		<b>DA</b> Dali Dim	<b>11</b> White
	<b>RG98</b> x2				2x10W	2552 lm		<b>DP</b> Phase Dim	<b>75</b> Grey
	<b>RG99</b>					2592 lm		<b>DC</b> CASAMBI	
								<b>D1</b> 0-10V Dim	

### Notes:

\* For complete code ordering information, please see page 377.

\*\* For other CCT options, please contact us.

For related accessories, please see page 69.

# MultiQuadro Deep



**MultiQuadro Deep**  
Adjustable Square Trim

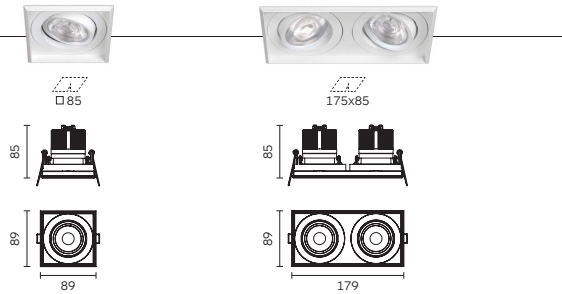

**MultiQuadro Deep**  
Adjustable Square Trimless

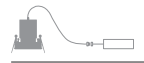
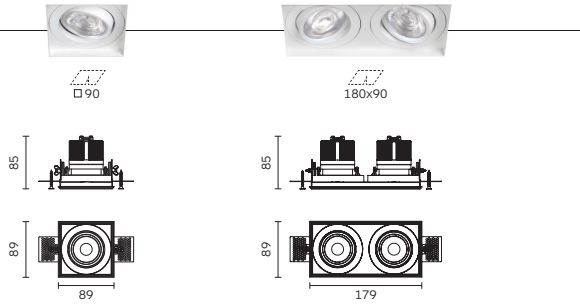

Code ordering example: **R G 1 6 M C 2 2 - 9 0 3 0 1 8 D 0 1 0**

	Product Code	Light Source Code*	>CRI	CCT**	LED Power	Nominal Lumen	Beam Angle (BA°)	Driver Options	Finish
MultiQuadro Deep Adjustable Square	<b>RG16</b> <input checked="" type="checkbox"/> x1	<b>MC22</b>	<b>90</b>	<b>30</b> 3000K	10W	1276 lm	<b>18 / 24 / 36</b>	<b>DO</b> No Dim	<b>10</b> <input checked="" type="checkbox"/> Black
	<b>RG17</b> <input type="checkbox"/> x1			<b>40</b> 4000K		1296 lm		<b>DA</b> Dali Dim	<b>11</b> <input type="checkbox"/> White
	<b>RG18</b> <input checked="" type="checkbox"/> x2				2x10W	2552 lm		<b>DP</b> Phase Dim	<b>75</b> <input checked="" type="checkbox"/> Grey
	<b>RG19</b> <input type="checkbox"/> x2					2592 lm		<b>DC</b> CASAMBI	<b>D1</b> 0-10V Dim

**Notes:**  
\* For complete code ordering information, please see page 377.  
\*\* For other CCT options, please contact us.  
For related accessories, please see page 69.

# MultiGiro Deep & MultiQuadro Deep Recessed Family configuration options

Code ordering example: **R G 9 6 M C 2 2 - 9 0 3 0 1 8 D 0 1 0**

## MultiGiro Deep & MultiQuadro Deep Adjustable

Product Code	Light Source Code	>CRI	CCT	LED Power	Nominal Lumen	Beam Angle (BA°)	Driver Options	Finish
<b>RG96</b> <input checked="" type="checkbox"/> x1 MultiGiro Deep	<b>MC22</b> Citizen COB	<b>90</b>	<b>30</b> 3000K	10W	1276 lm	<b>18 / 24 / 36</b>	<b>DO</b> No Dim	<b>10</b> <input checked="" type="checkbox"/> Black
<b>RG97</b> <input type="checkbox"/> x1			<b>40</b> 4000K		1296 lm		<b>DA</b> Dali Dim	<b>11</b> <input type="checkbox"/> White
<b>RG98</b> <input checked="" type="checkbox"/> x2	<b>MS11</b> Soraa SLE-16	<b>95</b>		8.1W	460 lm	<b>10</b>	<b>DP</b> Phase Dim	<b>75</b> <input checked="" type="checkbox"/> Grey
<b>RG99</b> <input type="checkbox"/> x2					480 lm		<b>DC</b> CASAMBI	<b>D1</b> 0-10V Dim
<b>RG16</b> <input checked="" type="checkbox"/> x1 MultiQuadro Deep				12.2W	720 lm	<b>15 / 25 / 36</b>		
<b>RG17</b> <input type="checkbox"/> x1					755 lm			
<b>RG18</b> <input checked="" type="checkbox"/> x2	<b>MX22</b> Xicato Artist XTM	<b>98</b>	<b>27</b> 2700K	10.6W	700 lm	<b>16 / 28 / 38</b>		
<b>RG19</b> <input type="checkbox"/> x2	<b>MX61</b> XIM			11.5W				
	<b>MX31</b> Beauty XTM	<b>95</b>		9.5W	931 lm	<b>28 / 35 / 45</b>		
	<b>MX71</b> XIM			11.5W				
	<b>MX41</b> Designer XTM	<b>90</b>		11.4W	1300 lm			
	<b>MX81</b> XIM			13.2W				
<b>GU53</b> Retrofit	MR16-GU5.3	<b>00</b>	<b>00</b>	/	/	<b>00</b>	<b>00</b> No Driver	
<b>GU10</b>	GZ10-GU10							

## Optical Accessories

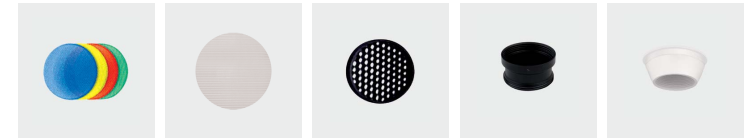

Product / Optical Accessories	Coloured Filters Colours 25, 42, 55, 85	Linear Spread Colour 41	Honeycomb Louvre Colour 10	Anti-Glare Cone Colour 10	Anti-Glare Hood Colours 10, 17
MultiGiro Deep	<b>2614*</b>	<b>2615</b>	<b>2504</b>	<b>2661</b>	<b>2675</b>
MultiQuadro Deep	<b>2614*</b>	<b>2615</b>	<b>2504</b>	<b>2661</b>	<b>2675</b>

\* With holder  
For Soraa specific accessories, please contact us and we will provide the detailed information.

**Notes:**  
For other CCT options, please contact us.

# Arena

Designed by **Franco Mirezzi** (Registered)



## Body

Round mounting trim in cast aluminum with brackets for trim installation on a ceiling thickness max. 30mm.

Luminaire body in cast aluminium designed with integrated heat-sink for a passive heat dissipation. Available in two sizes.

Equipped with easy pull-out mechanism, tiltable vertically 0-90° and rotatable horizontally 350°.

## LED sources

Citizen CLU series. SORAA SLE Optical Light Engine. Bridgelux V8 series.  
CRI: 90, 95 | CCT: 3000K, 4000K.  
Other CRI and CCT options available on request.

## Optic

Lens.  
Narrow, medium and wide beam angle available.

## Accessories

No accessories available.

## Finish

Powder coat in white or grey colour.

## Driver

Supplied with No-dimable remote driver.  
Dimming Options: 0-10V Dim, DALI, Phase, CASAMBI.

## Applications

A wall washing lighting system with the ability to illuminate the vertical surface and upper area of the wall. Provide effective illumination for display of merchandise.  
Application areas: retail, galleries, hospitality, residential, lobbies.

### Related Products



# Arena



## Arena 70 / 130

Adjustable

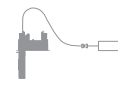
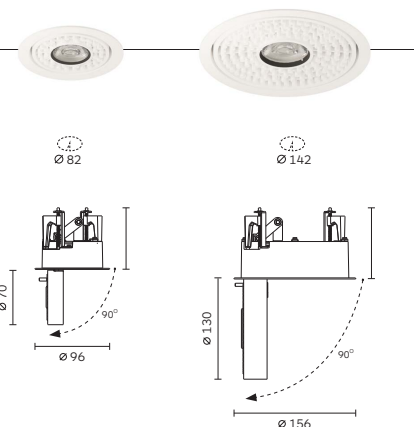

Code ordering example: **5 0 0 2 B C 3 1 - 9 0 3 0 1 9 D 0 1 0**

	Product Code	Light Source Code*	>CRI	CCT**	LED Power	Nominal Lumen	Beam Angle (BA°)	Driver Options	Finish
Arena 70 Adjustable	<b>5002</b> <b>BC31</b>	Citizen COB	<b>90</b>	<b>30</b> 3000K	6W	616 lm	<b>19 / 24 / 34</b>	<b>D0</b> No Dim	<b>10</b> Black
				<b>40</b> 4000K		643 lm		<b>DA</b> Dali Dim	<b>11</b> White
Arena 130 Adjustable	<b>5001</b> <b>BC22</b>	Citizen COB	<b>95</b>		12W	1552 lm		<b>DP</b> Phase Dim	
						1577 lm		<b>DC</b> CASAMBI	
						547 lm			
		<b>BS12</b> Soraa SLC-16		8.7W	524 lm	<b>10</b>	<b>D1</b> 0-10V Dim		
				9.8W	739 lm	<b>15 / 25 / 36</b>			
						775 lm			

### Notes:

\* For complete code ordering information, please see page 377.

\*\* For other CCT options, please contact us.

# MultiArena

Designed by Franco Mirenyi (Registered)



## Body

Square mounting trim in cast aluminum with clamps for trim/trimless installation mounting on a ceiling thickness max. 25mm.

Luminaire body in cast aluminium designed with integrated heat-sink for a passive heat dissipation. Available in two sizes and with configuration up to 3 light heads.

Tilttable 0-40° in all direction, and rotatable horizontally 350°.

## LED sources

Citizen CLU Series. SORAA SLE Optical Light Engine. CRI: 90, 95 | CCT: 3000K, 4000K. Other CRI and CCT options available on request.

## Optic

Lens. Narrow, medium and wide beam angle available.

## Accessories

No accessories available.

## Finish

Powder coat in black or white colour.

## Driver

Supplied with No-dimable remote driver. Dimming Options: 0-10V Dim, DALI, Phase, CASAMBI.

## Applications

A comprehensive lighting fixture with luminaire housing in crisp high tech material designed to act as heat management for the light source while offering excellent aiming flexibility. Application areas: retail, gyms, restaurants, hotels, window displays.

### Related Products

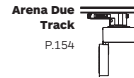

# MultiArena 70



### MultiArena 70 Adjustable Trim

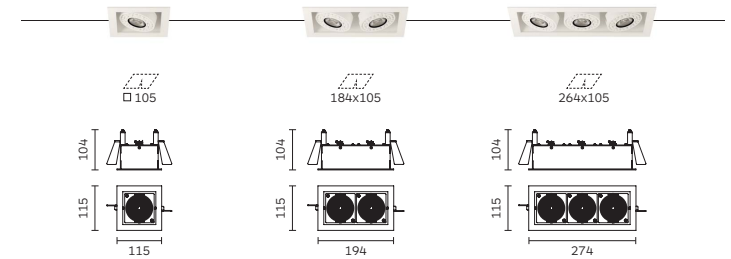

### MultiArena 70 Adjustable Trimless

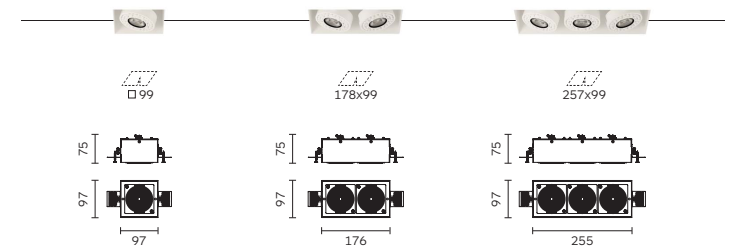

Code ordering example: **RE09BC31-903019D010**

	Product Code	Light Source Code*	>CRI	CCT**	LED Power	Nominal Lumen	Beam Angle (BA°)	Driver Options	Finish
MultiArena 70 Adjustable	<b>RE09</b> <input checked="" type="checkbox"/> x1	<b>BC31</b>	<b>90</b>	<b>30</b> 3000K	6W	616 lm	<b>19 / 24 / 34</b>	<b>D0</b> No Dim	<b>10</b> <input checked="" type="checkbox"/> Black
	<b>RE12</b> <input type="checkbox"/>			<b>40</b> 4000K		643 lm		<b>DA</b> Dali Dim	<b>11</b> <input type="checkbox"/> White
	<b>RE10</b> <input checked="" type="checkbox"/> x2				2x6W	1232 lm		<b>DP</b> Phase Dim	
	<b>RE13</b> <input type="checkbox"/>					1286 lm		<b>DC</b> CASAMBI	
	<b>RE11</b> <input checked="" type="checkbox"/> x3				3x6W	1848 lm		<b>D1</b> 0-10V Dim	
	<b>RE14</b> <input type="checkbox"/>					1929 lm			

### Notes:

\* For complete code ordering information, please see page 377.

\*\* For other CCT options, please contact us.

## MultiArena 130



**MultiArena 130**  
Adjustable Trim

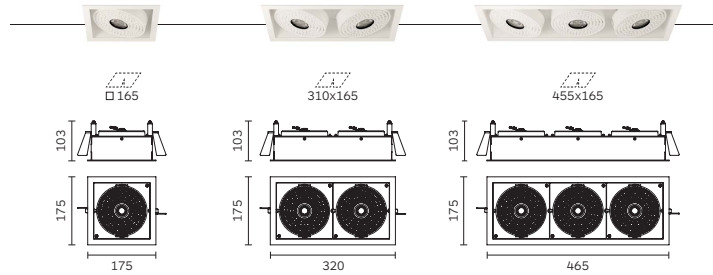

**MultiArena 130**  
Adjustable Trimless

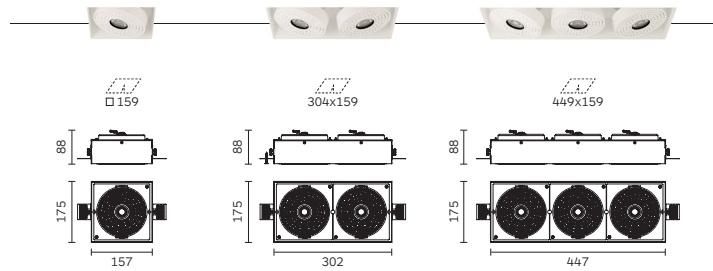

Code ordering example: RE03 BC22 - 90 30 19 D0 10

	Product Code	Light Source Code*	>CRI	CCT**	LED Power	Nominal Lumen	Beam Angle (BA°)	Driver Options	Finish
MultiArena 130 Adjustable	<b>RE03</b> <input checked="" type="checkbox"/> x1	<b>BC22</b>	<b>90</b>	<b>30</b> 3000K	12W	1522 lm	<b>19 / 24 / 34</b>	<b>D0</b> No Dim	<b>10</b> <input checked="" type="checkbox"/> Black
	<b>RE06</b> <input type="checkbox"/>			<b>40</b> 4000K		1577 lm		<b>DA</b> Dali Dim	<b>11</b> <input type="checkbox"/> White
	<b>RE04</b> <input checked="" type="checkbox"/> x2				2x12W	3044 lm		<b>DP</b> Phase Dim	
	<b>RE07</b> <input type="checkbox"/>					3154 lm		<b>DX</b> DMX	
	<b>RE05</b> <input checked="" type="checkbox"/> x3				3x12W	4566 lm		<b>DC</b> CASAMBI	
	<b>RE08</b> <input type="checkbox"/>					4731 lm		<b>D1</b> 0-10V Dim	

**Notes:**

- \* For complete code ordering information, please see page 377.
- \*\* For other CCT options, please contact us.

## MultiArena Recessed Family configuration options

Code ordering example: RE09 BC31 - 90 30 19 D0 10

### MultiArena 70

Adjustable

Product Code	Light Source Code	>CRI	CCT	LED Power	Nominal Lumen	Beam Angle (BA°)	Driver Options	Finish
<b>RE09</b> <input checked="" type="checkbox"/> x1	<b>BC31</b> Citizen COB	<b>90</b>	<b>30</b> 3000K	6W	616 lm	<b>19 / 24 / 34</b>	<b>D0</b> No Dim	<b>10</b> <input checked="" type="checkbox"/> Black
<b>RE12</b> <input type="checkbox"/>			<b>40</b> 4000K		643 lm		<b>DA</b> Dali Dim	<b>11</b> <input type="checkbox"/> White
<b>RE10</b> <input checked="" type="checkbox"/> x2							<b>DP</b> Phase Dim	
<b>RE13</b> <input type="checkbox"/>							<b>DC</b> CASAMBI	
<b>RE11</b> <input checked="" type="checkbox"/> x3							<b>D1</b> 0-10V Dim	
<b>RE14</b> <input type="checkbox"/>								

### MultiArena 130

Adjustable

Product Code	Light Source Code	>CRI	CCT	LED Power	Nominal Lumen	Beam Angle (BA°)	Driver Options	Finish
<b>RE03</b> <input checked="" type="checkbox"/> x1	<b>MC21</b> Citizen COB	<b>90</b>	<b>30</b> 3000K	12W	1552 lm	<b>19 / 24 / 34</b>	<b>D0</b> No Dim	<b>10</b> <input checked="" type="checkbox"/> Black
<b>RE06</b> <input type="checkbox"/>			<b>40</b> 4000K		1577 lm		<b>DA</b> Dali Dim	<b>11</b> <input type="checkbox"/> White
<b>RE04</b> <input checked="" type="checkbox"/> x2	<b>BS12</b> Soraa SLC-16	<b>95</b>		8.7W	524 lm	<b>10</b>	<b>DP</b> Phase Dim	
<b>RE07</b> <input type="checkbox"/>					547 lm		<b>DC</b> CASAMBI	
<b>RE05</b> <input checked="" type="checkbox"/> x3				9.8W	739 lm	<b>15 / 25 / 36</b>	<b>D1</b> 0-10V Dim	
<b>RE08</b> <input type="checkbox"/>					775 lm			

**Notes:**

- For other CCT options, please contact us.

# Colosseo

Recessed 90 | 120



## Body

Round mounting trim in cast aluminium with brackets for trimless installation on a ceiling thickness 6-25 mm.

Luminaire body inclusive of snoot in cast aluminium (with inner part painted in black).  
Easy relamping via removable front ring by snap-in catch action.

Available in 2 sizes.

Tilttable in two directions up to 30°.

## LED sources

Citizen CLU Series.

CRI: 90 | CCT: 3000K, 4000K.

Other CRI and CCT options available on request.

## Optic

Lens.

Narrow, medium and wide beam angle available.

## Accessories

No accessories available.

## Finish

Powder coat in white colour.

Snoot inner part painted in black colour.

## Driver

Supplied with No-dimable remote driver.

Dimming Options: 0-10V Dim, DALI, Phase, CASAMBI.

## Applications

A fully adjustable light head designed to accommodate any recessed lighting application and allow lamp aiming while power is on.

Application areas: retail, shopping centers, corridors, window display.

## Related Products

**MultiGiro  
Deep  
Recessed**



P.66

**Gimbalo  
Recessed**



P.78

# Colosseo



## Colosseo 90 / 120

Adjustable Trim

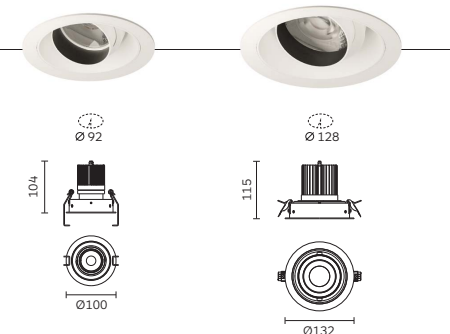

## Colosseo 90 / 120

Adjustable Trimless

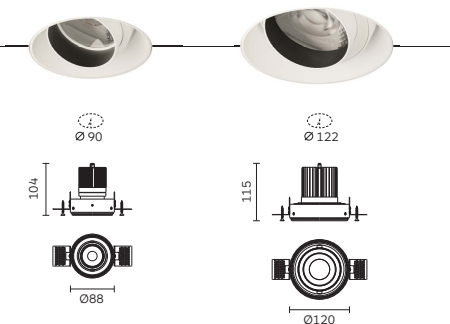

Code ordering example: **R K 8 5 M C 2 2 - 9 0 3 0 1 8 D 0 1 1**

	Product Code	Light Source Code*	>CRI	CCT**	LED Power	Nominal Lumen	Beam Angle (BA°)	Driver Options	Finish	
Colosseo 90 Adjustable	<b>RO32</b>	<b>MC22</b> Citizen	COB	<b>90</b>	<b>30</b> 3000K	18W	1238 lm	<b>18 / 24 / 36</b>	<b>D0</b> No Dim	<b>11</b> White
	<b>RO44</b>			<b>40</b>	4000K		1260 lm		<b>DA</b> Dali Dim	
Colosseo 120 Adjustable	<b>RO33</b>	<b>MC33</b> Citizen	COB			21W	2200 lm	<b>15 / 24 / 38</b>	<b>DP</b> Phase Dim	
	<b>RO23</b>						2300 lm		<b>DC</b> CASAMBI	
									<b>D1</b> 0-10V Dim	

## Notes:

\* For complete code ordering information, please see page 377.

\*\* For other CCT options, please contact us.

# Gimbalo

Recessed 60 | 100 | 130



## Body

Round shape mounting trim in cast aluminium with springs for trim installation on ceiling thickness 1-25mm or bracket for trimless installation on a ceiling thickness 12.5 or -15 mm.

Fully adjustable gimbals and luminaire body in cast aluminium. Available in 3 sizes.

Tilttable on a dual axis gimbals up to 40° in all directions.

## LED sources

Citizen CLU Series. Xicato Artist, Beauty and Designer Series. SORAA SLE Optical Light Engine. CRI: 90, 95, 98 | CCT: 2700K, 3000K, 4000K. Other CRI and CCT options, Tuneable White and DimToWarm versions available on request.

## Optic

Lens. Narrow, medium and wide beam angle available.

## Accessories

Coloured filters, linear spread, honeycomb louvre, anti-glare hood.

Snap System™ accessories available for SORAA SLE series with narrow beam angle.

## Finish

Powder coat in black, white or grey colour.

## Driver

Supplied with No-dimable remote driver. Dimming Options: 0-10V Dim, DALI, Phase, CASAMBI.

## Applications

Features a fully adjustable double gimbal concept design elegant luminaire to accommodate any recessed lighting application.

Application areas: retails, shopping centers, corridors, window display.

## Related Products



# Gimbalo



Gimbalo 60 / 100 / 130  
Adjustable Trim

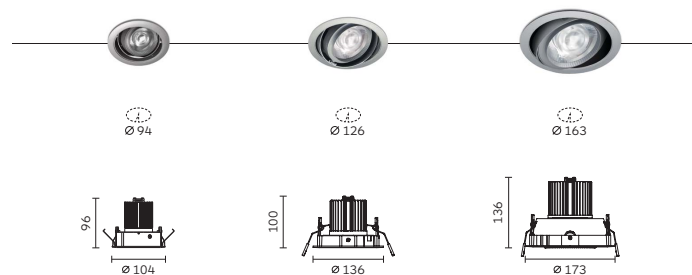

Gimbalo 60 / 100 / 130  
Adjustable Trimless

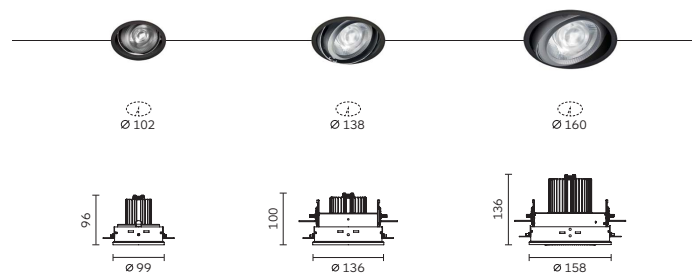

Code ordering example: **R L 5 2 M C 2 2 - 9 0 3 0 1 8 D 0 1 0**

	Product Code	Light Source Code*	>CRI	CCT**	LED Power	Nominal Lumen	Beam Angle (BA°)	Driver Options	Finish
Gimbalo 60 Adjustable	<b>RL52</b> <input checked="" type="radio"/>	<b>MC22</b>	<b>90</b>	<b>30</b> 3000K	11W	1238 lm	<b>18 / 24 / 36</b>	<b>D0</b> No Dim	<b>10</b> <input checked="" type="checkbox"/> Black
	<b>RL53</b> <input type="radio"/>			<b>40</b> 4000K		1260 lm		<b>DA</b> Dali Dim	<b>11</b> <input type="checkbox"/> White
Gimbalo 100 Adjustabel	<b>RG04</b> <input checked="" type="radio"/>	<b>MC33</b>			21W	2200 lm	<b>15 / 24 / 38</b>	<b>DP</b> Phase Dim	<b>75</b> <input checked="" type="checkbox"/> Grey
	<b>RG05</b> <input type="radio"/>					2300 lm		<b>DC</b> CASAMBI	
Gimbalo 130 Adjustable	<b>RH01</b> <input checked="" type="radio"/>				33W	3220 lm	<b>12 / 22 / 32</b>	<b>D1</b> 0-10V Dim	
	<b>RH02</b> <input type="radio"/>					3300 lm			

## Notes:

\* For complete code ordering information, please see page 377.

\*\* For other CCT options, please contact us.

For related accessories, please see page 81.



## Gimbalo Recessed Family configuration options

Code ordering example: R L52 MC22 - 90 30 18 D0 10

### Gimbalo 60

Adjustable

Product Code	Light Source Code	>CRI	CCT	LED Power	Nominal Lumen	Beam Angle (BA°)	Driver Options	Finish
<b>RL52</b> ●	<b>MC22</b> Citizen COB	<b>90</b>	<b>30</b> 3000K	11W	1238 lm	<b>18 / 24 / 36</b>	<b>D0</b> No Dim	<b>10</b> ■ Black
<b>RL53</b> ○			<b>40</b> 4000K		1260 lm		<b>DA</b> Dali Dim	<b>11</b> □ White
	<b>MS11</b> Soraa SLE-16	<b>95</b>		8.1W	460 lm	<b>10</b>	<b>DP</b> Phase Dim	<b>75</b> ■ Grey
					480 lm		<b>DC</b> CASAMBI	
				12.2W	720 lm	<b>25 / 36</b>	<b>D1</b> 0-10V Dim	
					755 lm			
	<b>MX22</b> Xicato Artist XTM	<b>98</b>	<b>27</b> 2700K	10.6W	700 lm	<b>16 / 28 / 38</b>		
	<b>MX61</b>			11.5W				
	<b>MX31</b> Beauty XTM	<b>95</b>		9.5W	931 lm	<b>28 / 35 / 45</b>		
	<b>MX71</b>			11.5W				
	<b>MX41</b> Designer XTM	<b>90</b>		11.4W	1300 lm			
	<b>MX81</b>			13.2W				
	<b>GU53</b> Retrofit MR16-GU5.3	<b>00</b>	<b>00</b>	/	/	<b>00</b>	<b>00</b> No Driver	
	<b>GU10</b> GZ10-GU10							

### Gimbalo 100

Adjustable

Product Code	Light Source Code	>CRI	CCT	LED Power	Nominal Lumen	Beam Angle (BA°)	Driver Options	Finish
<b>RG04</b> ●	<b>MC33</b> Citizen COB	<b>90</b>	<b>30</b> 3000K	21W	2200 lm	<b>15 / 24 / 38</b>	<b>D0</b> No Dim	<b>10</b> ■ Black
<b>RG05</b> ○			<b>40</b> 4000K		2300 lm		<b>DA</b> Dali Dim	<b>11</b> □ White
	<b>MX25</b> Xicato Artist XTM	<b>98</b>	<b>27</b> 2700K	20W	2000 lm	<b>25 / 36 / 45</b>	<b>DP</b> Phase Dim	<b>75</b> ■ Grey
	<b>MX65</b>			24.4W			<b>DC</b> CASAMBI	
	<b>MX32</b> Beauty XTM	<b>95</b>		20W	2000 lm		<b>D1</b> 0-10V Dim	
	<b>MX72</b>			24.4W				
	<b>MX43</b> Designer XTM	<b>90</b>		25.6W	3000 lm			
	<b>MX83</b>			31.8W				

### Gimbalo 130

Adjustable

Product Code	Light Source Code	>CRI	CCT	LED Power	Nominal Lumen	Beam Angle (00°)	Driver Options	Finish
<b>RH01</b> ●	<b>MC33</b> Citizen COB	<b>90</b>	<b>30</b> 3000K	33W	3220 lm	<b>12 / 22 / 32</b>	<b>D0</b> No Dim	<b>10</b> ■ Black
<b>RH02</b> ○			<b>40</b> 4000K		3300 lm		<b>DA</b> Dali Dim	<b>11</b> □ White
	<b>MS21</b> Soraa SLE-30	<b>95</b>		16.1W	1000 lm	<b>9 / 25 / 36</b>	<b>DP</b> Phase Dim	<b>75</b> ■ Grey
					1050 lm		<b>DC</b> CASAMBI	
							<b>D1</b> 0-10V Dim	
	<b>AR11</b> Retrofit AR111	<b>00</b>	<b>00</b>	/	/	<b>00</b>	<b>00</b> No Driver	

#### Notes:

For other CCT options, please contact us.

## Optical Accessories

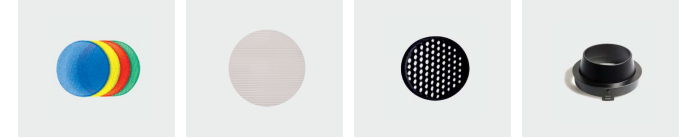

Product / Optical Accessories	Coloured Filters Colours 25, 42, 55, 85	Linear Spread Colour 41	Honeycomb Louvre Colour 10	Anti-Glare Hood Colours 10, 17
Gimbalo 60	<b>2662*</b>	<b>2663</b>	<b>2634</b>	<b>2321</b>
Gimbalo 100	<b>2887*</b>	<b>2888</b>	<b>2633</b>	<b>2869</b>
Gimbalo 130	<b>2599*</b>	<b>2598</b>	<b>2334</b>	<b>2327</b>

\*With holder

For Soraa specific accessories, please contact us and we will provide the detailed information.

# MultiGimbalo

Recessed 60 | 100 | 130



## Body

Square shape mounting trim in cast aluminium with twist and lock mechanism for trim installation on ceiling thickness 1-25mm or bracket for trimless installation on a ceiling thickness 12.5 or 15 mm.

Fully adjustable gimbals and luminaire body in cast aluminium. Available in 3 sizes and in configuration up to 3 light heads.

Tilttable on a dual axis gimbals up to 40° in all directions.

## Accessories

Coloured filters, linear spread, honeycomb louvre, anti-glare hood, anti-glare tube.  
Snap System™ accessories available for SORAA SLE series with narrow beam angle.

## Finish

Powder coat in black, white or grey colour.

## LED sources

Citizen CLU Series. Xicato Artist, Beauty and Designer Series. SORAA SLE Optical Light Engine.  
CRI: 90, 95, 98 | CCT: 2700K, 3000K, 4000K.  
Other CRI and CCT options, Tuneable White and DimToWarm versions available on request.

## Optic

Lens.  
Narrow, medium and wide beam angle available.

## Driver

Supplied with No-dimable remote driver.  
Dimming Options: 0-10V Dim, DALI, Phase, CASAMBI.

## Applications

Luminaire features a fully adjustable double gimbal concept combined with an elegant design. Ideal to accommodate any recessed lighting application.  
Application areas: retail, shopping centers, corridors, window display.

## Related Products



## MultiGimbalo 60



### MultiGimbalo 60 Adjustable Trim

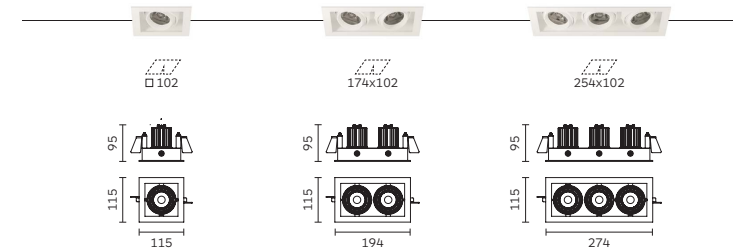

### MultiGimbalo 60 Adjustable Trimless

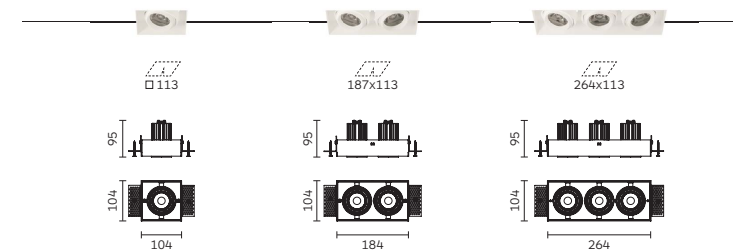

Code ordering example: **R K 8 6 M C 2 2 - 9 0 3 0 1 8 D 0 1 0**

	Product Code	Light Source Code*	>CRI	CCT**	LED Power	Nominal Lumen	Beam Angle (BA°)	Driver Options	Finish
MultiGimbalo 60 Adjustable	<b>RK86</b> <input checked="" type="checkbox"/> x1	<b>MC22</b>	<b>90</b>	<b>30</b> 3000K	11W	1238 lm	<b>18 / 24 / 36</b>	<b>DO</b> No Dim	<b>10</b> <input checked="" type="checkbox"/> Black
	<b>RK89</b> <input type="checkbox"/>			<b>40</b> 4000K		1260 lm		<b>DA</b> Dali Dim	<b>11</b> <input type="checkbox"/> White
	<b>RK87</b> <input checked="" type="checkbox"/> x2				2x11W	2476 lm		<b>DP</b> Phase Dim	<b>75</b> <input type="checkbox"/> Grey
	<b>RK90</b> <input type="checkbox"/>					2520 lm		<b>DC</b> CASAMBI	
	<b>RK88</b> <input checked="" type="checkbox"/> x3				3x11W	3714 lm		<b>D1</b> 0-10V Dim	
	<b>RK91</b> <input type="checkbox"/>					3780 lm			

### Notes:

\* For complete code ordering information, please see page 377.  
\*\* For other CCT options, please contact us.  
For related accessories, please see page 87.

## MultiGimbalo 100



### MultiGimbalo 100

Adjustable Trim

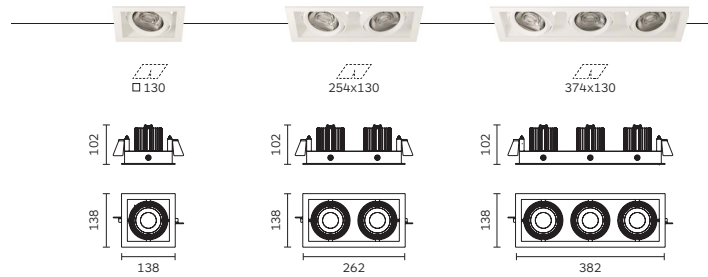

### MultiGimbalo 100

Adjustable Trimless

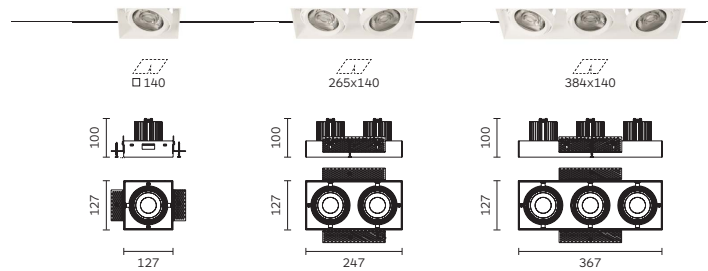

Code ordering example: **R J 2 1 M C 3 3 - 9 0 3 0 1 5 D 0 1 0**

	Product Code	Light Source Code*	>CRI	CCT**	LED Power	Nominal Lumen	Beam Angle (BA°)	Driver Options	Finish
MultiGimbalo 100 Adjustable	<b>RJ21</b> <input checked="" type="checkbox"/> x1	<b>MC33</b>	<b>90</b>	<b>30</b> 3000K	21W	2200 lm	<b>15 / 24 / 38</b>	<b>DO</b> No Dim	<b>10</b> <input type="checkbox"/> Black
	<b>RL24</b> <input type="checkbox"/>			<b>40</b> 4000K		2300 lm		<b>DA</b> Dali Dim	<b>11</b> <input type="checkbox"/> White
	<b>RJ22</b> <input checked="" type="checkbox"/> x2				2x21W	4400 lm		<b>DP</b> Phase Dim	<b>75</b> <input type="checkbox"/> Grey
	<b>RL25</b> <input type="checkbox"/>					4600 lm		<b>DC</b> CASAMBI	
	<b>RJ23</b> <input checked="" type="checkbox"/> x3				3x21W	6600 lm		<b>D1</b> 0-10V Dim	
	<b>RL26</b> <input type="checkbox"/>					6900 lm			

#### Notes:

\* For complete code ordering information, please see page 377.

\*\* For other CCT options, please contact us.

For related accessories, please see page 87.

## MultiGimbalo 130



### MultiGimbalo 130

Adjustable Trim

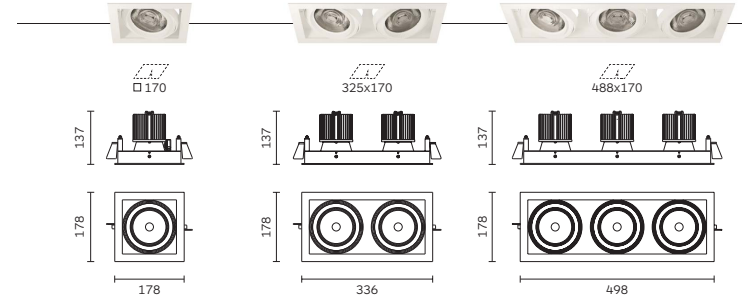

### MultiGimbalo 130

Adjustable Trimless

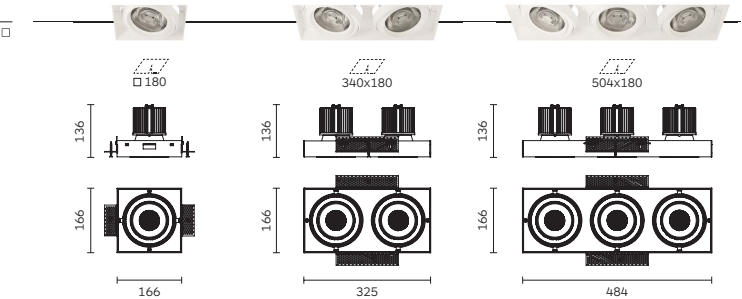

Code ordering example: **R L 2 7 M C 3 3 - 9 0 3 0 1 2 D 0 1 0**

	Product Code	Light Source Code*	>CRI	CCT**	LED Power	Nominal Lumen	Beam Angle (BA°)	Driver Options	Finish
MultiGimbalo 130 Adjustable	<b>RL27</b> <input checked="" type="checkbox"/> x1	<b>MC33</b>	<b>90</b>	<b>30</b> 3000K	33W	3220 lm	<b>12 / 22 / 32</b>	<b>DO</b> No Dim	<b>10</b> <input type="checkbox"/> Black
	<b>RL30</b> <input type="checkbox"/>			<b>40</b> 4000K		3300 lm		<b>DA</b> Dali Dim	<b>11</b> <input type="checkbox"/> White
	<b>RL28</b> <input checked="" type="checkbox"/> x2				2x33W	6440 lm		<b>DP</b> Phase Dim	<b>75</b> <input type="checkbox"/> Grey
	<b>RL31</b> <input type="checkbox"/>					6600 lm		<b>DC</b> CASAMBI	
	<b>RL29</b> <input checked="" type="checkbox"/> x3				3x33W	9660 lm		<b>D1</b> 0-10V Dim	
	<b>RL32</b> <input type="checkbox"/>					9900 lm			

#### Notes:

\* For complete code ordering information, please see page 377.

\*\* For other CCT options, please contact us.

For related accessories, please see page 87.

## MultiGimbalo Recessed Family configuration options

Code ordering example: R K 8 6 M C 2 2 - 9 0 3 0 1 8 D 0 1 0

### MultiGimbalo 60

Adjustable

Product Code	Light Source Code	>CRI	CCT	LED Power	Nominal Lumen	Beam Angle (BA°)	Driver Options	Finish
<b>RK66</b> <input checked="" type="checkbox"/> x1	<b>MC22</b> Citizen COB	<b>90</b>	<b>30</b> 3000K	11W	1238 lm	<b>18 / 24 / 35</b>	<b>D0</b> No Dim	<b>10</b> <input checked="" type="checkbox"/> Black
<b>RK89</b> <input type="checkbox"/>			<b>40</b> 4000K		1260 lm		<b>DA</b> Dali Dim	<b>11</b> <input type="checkbox"/> White
<b>RK87</b> <input checked="" type="checkbox"/> x2	<b>MS11</b> Soraa SLE-16	<b>95</b>		8.1W	460 lm	<b>10</b>	<b>DP</b> Phase Dim	<b>75</b> <input checked="" type="checkbox"/> Grey
<b>RK90</b> <input type="checkbox"/>					480 lm		<b>DC</b> CASAMBI	
<b>RK88</b> <input checked="" type="checkbox"/> x3				12.2W	720 lm	<b>25 / 36</b>	<b>D1</b> 0-10V Dim	
<b>RK91</b> <input type="checkbox"/>					755 lm			
	<b>MX22</b> Xicato Artist XTM	<b>98</b>	<b>27</b> 2700K	10.6W	700 lm	<b>16 / 28 / 38</b>		
	<b>MX61</b> XIM			11.5W				
	<b>MX31</b> Beauty XTM	<b>95</b>		9.5W	931 lm	<b>28 / 35 / 45</b>		
	<b>MX71</b> XIM			11.5W				
	<b>MX41</b> Designer XTM	<b>90</b>		11.4W	1300 lm			
	<b>MX81</b> XIM			13.2W				
	<b>GU53</b> Retrofit MR16-GU5.3	<b>00</b>	<b>00</b>	/	/	<b>00</b>	<b>00</b> No Driver	
	<b>GU10</b> GZ10-GU10							

### MultiGimbalo 100

Adjustable

Product Code	Light Source Code	>CRI	CCT	LED Power	Nominal Lumen	Beam Angle (BA°)	Driver Options	Finish
<b>RJ21</b> <input checked="" type="checkbox"/> x1	<b>MC33</b> Citizen COB	<b>90</b>	<b>30</b> 3000K	21W	2200 lm	<b>15 / 24 / 38</b>	<b>D0</b> No Dim	<b>10</b> <input checked="" type="checkbox"/> Black
<b>RL24</b> <input type="checkbox"/>			<b>40</b> 4000K		2300 lm		<b>DA</b> Dali Dim	<b>11</b> <input type="checkbox"/> White
<b>RJ22</b> <input checked="" type="checkbox"/> x2	<b>MX25</b> Xicato Artist XTM	<b>98</b>	<b>27</b> 2700K	20W	2000 lm	<b>25 / 36 / 45</b>	<b>DP</b> Phase Dim	<b>75</b> <input checked="" type="checkbox"/> Grey
<b>RL25</b> <input type="checkbox"/>	<b>MX65</b> XIM			24.4W			<b>DC</b> CASAMBI	
<b>RJ23</b> <input checked="" type="checkbox"/> x3	<b>MX32</b> Beauty XTM	<b>95</b>		20W	2000 lm		<b>D1</b> 0-10V Dim	
<b>RL26</b> <input type="checkbox"/>	<b>MX72</b> XIM			24.4W				
	<b>MX43</b> Designer XTM	<b>90</b>		25.6W	3000 lm			
	<b>MX83</b> XIM			31.8W				

### MultiGimbalo 130

Adjustable

Product Code	Light Source Code	>CRI	CCT	LED Power	Nominal Lumen	Beam Angle (BA°)	Driver Options	Finish
<b>RL27</b> <input checked="" type="checkbox"/> x1	<b>MC33</b> Citizen COB	<b>90</b>	<b>30</b> 3000K	33W	3200 lm	<b>12 / 22 / 32</b>	<b>D0</b> No Dim	<b>10</b> <input checked="" type="checkbox"/> Black
<b>RL30</b> <input type="checkbox"/>			<b>40</b> 4000K		3300 lm		<b>DA</b> Dali Dim	<b>11</b> <input type="checkbox"/> White
<b>RL28</b> <input checked="" type="checkbox"/> x2	<b>MS21</b> Soraa SLE-30	<b>95</b>		16.1W	1000 lm	<b>9 / 25 / 36</b>	<b>DP</b> Phase Dim	<b>75</b> <input checked="" type="checkbox"/> Grey
<b>RL31</b> <input type="checkbox"/>					1050 lm		<b>DC</b> CASAMBI	
<b>RL29</b> <input checked="" type="checkbox"/> x3							<b>D1</b> 0-10V Dim	
<b>RL32</b> <input type="checkbox"/>	<b>AR11</b> Retrofit AR111	<b>00</b>	<b>00</b>	/	/	<b>00</b>	<b>00</b> No Driver	

#### Notes:

For other CCT options, please contact us.

## Optical Accessories

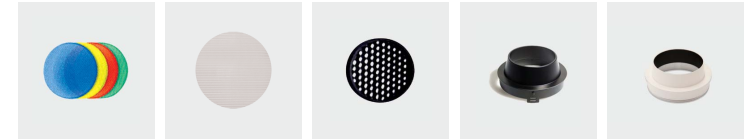

Product / Optical Accessories	Coloured Filters Colours 25, 42, 55, 85	Linear Spread Colour 41	Honeycomb Louvre Colour 10	Anti-Glare Hood Colours 10, 17	Anti-Glare Tube Colours 10, 17
MultiGimbalo 60	<b>2662*</b>	<b>2663</b>	<b>2634</b>	<b>2321</b>	<b>2418</b>
MultiGimbalo 100	<b>2B87*</b>	<b>2B88</b>	<b>2633</b>	<b>2B69</b>	<b>2B82</b>
MultiGimbalo 130	<b>2599*</b>	<b>2598</b>	<b>2334</b>	<b>2327</b>	<b>2C44</b>

\* With holder

For Soraa specific accessories, please contact us and we will provide the detailed information.

# Roller In & Out

Recessed 102 | 136 | 195



## Body

Round mounting trim in cast aluminium with springs for trim installation on a ceiling thickness max. 25mm.

Luminaire body in cast aluminium and thermoplastic materials. Easy relamping via removable front ring by snap-in catch action (195 and 136) or via twist and lock action (102).

Tilttable with In&Out mechanism. **Roller 102:** In 25° - Out 30°; **Roller 136:** In 30° - Out 50°; **Roller 195:** In 40° - Out 60°.

## Accessories

Coloured filters, refractor, honeycomb louvre.

## Finish

Powder coat in black or white colour.

## LED sources

Citizen CLU Series. Xicato Artist, Beauty and Designer Series.

CRI: 90, 95, 98 | CCT: 2700K, 3000K, 4000K.  
Other CRI and CCT options, Tuneable White and DimToWarm versions available on request.

## Optic

Reflector + diffuser.  
Narrow, medium and wide beam angle available.

## Driver

Supplied with No-dimable remote driver.  
Retrofit version Supplied with no driver.  
Dimming Options: 0-10V Dim, DALI, Phase, CASAMBI.

## Applications

An ideal lighting system when there is a special demand for maximum flexibility of lighting coverage.  
Application areas: retail, gyms, galleries, showrooms, residential, restaurants, hotels, window displays.

## Related Products

**Palla In & Out Recessed**  
P.28



## Roller In & Out



**Roller In & Out 102 / 136 / 159**  
Adjustable Trim

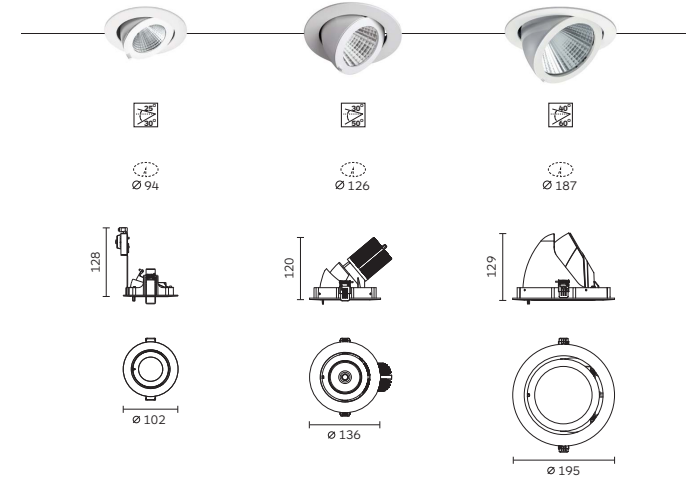

Code ordering example: **5 7 7 2 G U 5 3 - 0 0 0 0 0 0 1 0**

	Product Code	Light Source Code*	>CRI	CCT**	LED Power	Nominal Lumen	Beam Angle (BA°)	Driver Options	Finish
Roller In & Out 102 Adjustable	<b>5772</b>	<b>G U53</b>	<b>00</b>	<b>00</b>	/	/	<b>00</b>	<b>00</b> No Driver	<b>10</b> ■ Black <b>11</b> □ White
Roller In & Out 136 Adjustable	<b>RE29</b>	<b>BC22</b>	<b>90</b>	<b>30</b> 3000K <b>40</b> 4000K	25W	2602 lm 2643 lm	<b>12 / 22 / 38</b>	<b>D0</b> No Dim <b>DA</b> Dali Dim	
Roller In & Out 195 Adjustable	<b>RD29</b>	<b>BC21</b>			38W	4114 lm 4177 lm	<b>12 / 26 / 38</b>	<b>DP</b> Phase Dim <b>DC</b> CASAMBI <b>D1</b> 0-10V Dim	

### Notes:

\* For complete code ordering information, please see page 377.

\*\* For other CCT options, please contact us.



For related accessories, please see page 91.

## Roller In & Out Recessed Family configuration options

Code ordering example: 5 7 7 2 GU53 - 00 00 00 00 10



### Roller In & Out 102

Adjustable

Product Code	Light Source Code	>CRI	CCT	LED Power	Nominal Lumen	Beam Angle (BA°)	Driver Options	Finish
<b>5772</b> 	<b>GU53</b> Retrofit <b>GU10</b>	MR16-GU5.3 GZ10-GU10	<b>00</b>	<b>00</b>	/	/	<b>00</b> No Driver	<b>10</b>  Black <b>11</b>  White



### Roller In & Out 136

Adjustable

Product Code	Light Source Code	>CRI	CCT	LED Power	Nominal Lumen	Beam Angle (BA°)	Driver Options	Finish	
<b>RE29</b> 	<b>MC22</b> Citizen	COB	<b>90</b>	<b>30</b> 3000K	25W	2602 lm	<b>15 / 24 / 36</b>	<b>D0</b> No Dim	<b>10</b>  Black
			<b>40</b>	4000K		2643 lm		<b>DA</b> Dali Dim	<b>11</b>  White
<b>BX25</b>	Xicato	Artist	XTM	<b>98</b>	<b>27</b> 2700K	20W	2000 lm	<b>30 / 42 / 55</b>	<b>DP</b> Phase Dim
<b>BX32</b>		Beauty	XTM	<b>95</b>					<b>DC</b> CASAMBI
<b>BX42</b>		Designer	XTM	<b>90</b>		17.1W			<b>D1</b> 0-10V Dim

### Roller In & Out 195

Adjustable

Product Code	Light Source Code	>CRI	CCT	LED Power	Nominal Lumen	Beam Angle (BA°)	Driver Options	Finish	
<b>RD29</b> 	<b>MC21</b> Citizen	COB	<b>90</b>	<b>30</b> 3000K	38W	4114 lm	<b>12 / 22 / 40</b>	<b>D0</b> No Dim	<b>10</b>  Black
			<b>40</b>	4000K		4177 lm		<b>DA</b> Dali Dim	<b>11</b>  White
<b>BX26</b>	Xicato	Artist	XTM	<b>98</b>	<b>27</b> 2700K	30.5W	3000 lm	<b>20 / 40 / 60</b>	<b>DP</b> Phase Dim
<b>BX43</b>		Designer	XTM	<b>90</b>		25.7W			<b>DC</b> CASAMBI
									<b>D1</b> 0-10V Dim
<b>GU53</b>	Retrofit	MR16-GU5.3	<b>00</b>	<b>00</b>	/	/	<b>00</b>	<b>00</b> No Driver	

#### Notes:

For other CCT options, please contact us.

## Optical Accessories

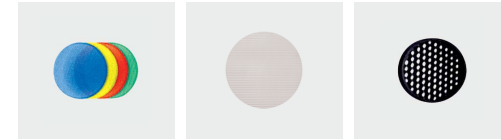

Product / Optical Accessories	Coloured Filters Colours 25, 42, 55, 85	Refractor Colour 41	Honeycomb Louvre Colour 10
Roller In & Out 136	/	/	<b>2368</b>
Roller In & Out 195	<b>2889*</b>	<b>2890</b>	<b>2367</b>

\* With holder

For Soraa specific accessories, please contact us and we will provide the detailed information.

# Ovo

Recessed 65 | 90 | 160

Fixed / Adjustable



## Body

Round shape mounting trim in cast aluminium with brackets (160) or clamps (90, 65) for trim installation on ceiling thickness max. 12mm or brackets for trimless installation on ceiling thickness max. 30mm.

Luminaire body in cast aluminium. Regressed lamp holder position for minimum glare.

Adjustable version: Ovo 65 tiltable vertically 0-25°; Ovo 90 tiltable vertically 0-30°; Ovo 160 tiltable vertically 0-20°. All model rotatable horizontally 350°.

## Accessories

No accessories available.

## Finish

Powder coat in black, white or grey colour.

## LED sources

Citizen CLU Series. Xicato Artist, Beauty and Designer Series. SORAA SLE Optical Light Engine. CRI: 90, 95, 98 | CCT: 2700K, 3000K, 4000K. Other CRI and CCT options, Tuneable White and DimToWarm versions available on request.

## Optic

Lens (65), Reflector + diffuser (90, 160). Narrow, medium and wide beam angle available.

## Driver

Supplied with No-dimable remote driver. Dimming Options: 0-10V Dim, DALI, Phase, CASAMBI.

## Applications

Organic form, provides excellent glare control to minimize impact while piercing through ambient light levels to meet the highest functional requirements of architectural lighting design.

Application areas: hotels, residential, retail, galleries.

### Related Products

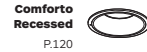

# Ovo



Ovo 65 / 90 / 160  
Fixed Trim

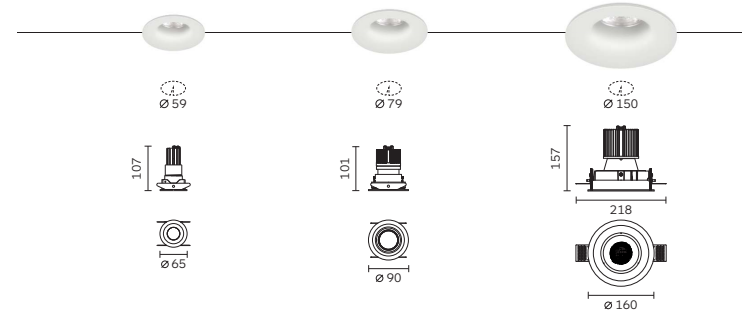

Ovo 65 / 90 / 160  
Fixed Trimless

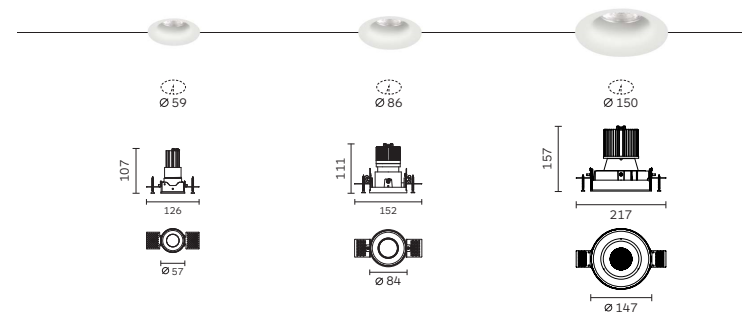

Code ordering example: **R J 7 6 M C 3 1 - 9 0 3 0 1 6 D 0 1 0**

	Product Code	Light Source Code*	>CRI	CCT**	LED Power	Nominal Lumen	Beam Angle (BA°)	Driver Options	Finish
Ovo 65	<b>RJ76</b>	<b>MC31</b>	<b>90</b>	<b>30</b> 3000K	6W	616 lm	<b>16 / 24 / 32</b>	<b>D0</b> No Dim	<b>10</b> Black
Fixed	<b>RJ77</b>			<b>40</b> 4000K		643 lm		<b>DA</b> Dali Dim	<b>11</b> White
Ovo 90	<b>RJ68</b>	<b>MC22</b>			11W	1238 lm	<b>18 / 24 / 34</b>	<b>DP</b> Phase Dim	<b>75</b> Grey
Fixed	<b>RJ72</b>					1260 lm		<b>DC</b> CASAMBI	
Ovo 160	<b>RJ63</b>	<b>MC33</b>			33W	3220 lm	<b>12 / 22 / 32</b>	<b>D1</b> 0-10V Dim	
Fixed	<b>RJ64</b>					3300 lm			

### Notes:

\* For complete code ordering information, please see page 377.

\*\* For other CCT options, please contact us.

## Ovo

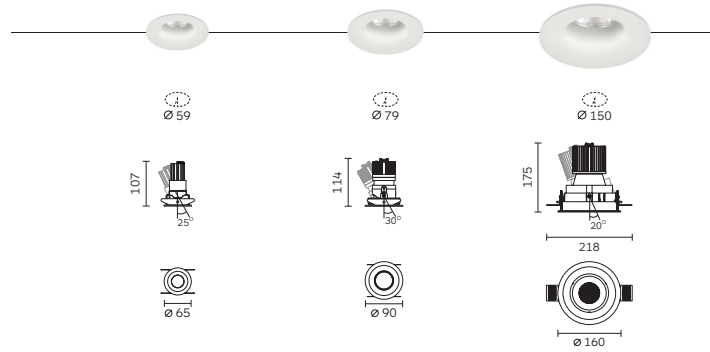

## Ovo 65 / 90 / 160

Adjustable Trim 

## Ovo 65 / 90 / 160

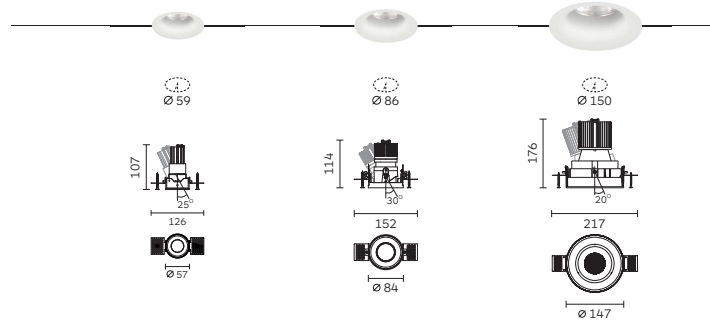
Adjustable Trimless Code ordering example: R J 2 9 M C 3 1 - 9 0 3 0 1 6 D 0 1 0

	Product Code	Light Source Code*	>CRI	CCT**	LED Power	Nominal Lumen	Beam Angle (BA°)	Driver Options	Finish
Ovo 65 Adjustable	<b>RJ29</b> <input checked="" type="radio"/>	<b>MC31</b>	<b>90</b>	<b>30</b> 3000K	6W	616 lm	<b>16 / 24 / 32</b>	<b>D0</b> No Dim	<b>10</b> <input checked="" type="checkbox"/> Black
	<b>RJ30</b> <input type="radio"/>			<b>40</b> 4000K		643 lm		<b>DA</b> Dali Dim	<b>11</b> <input type="checkbox"/> White
Ovo 90 Adjustable	<b>RH31</b> <input checked="" type="radio"/>	<b>MC22</b>			11W	1238 lm	<b>18 / 24 / 34</b>	<b>DP</b> Phase Dim	<b>75</b> <input checked="" type="checkbox"/> Grey
	<b>RJ31</b> <input type="radio"/>					1260 lm		<b>DC</b> CASAMBI	
Ovo 160 Adjustable	<b>RJ32</b> <input checked="" type="radio"/>	<b>MC33</b>			33W	3220 lm	<b>12 / 22 / 32</b>	<b>D1</b> 0-10V Dim	
	<b>RJ33</b> <input type="radio"/>					3300 lm			

## Notes:

\* For complete code ordering information, please see page 377.

\*\* For other CCT options, please contact us.

## Ovo Recessed Family configuration options

Code ordering example: R J 7 6 M C 3 1 - 9 0 3 0 1 6 D 0 1 0

## Ovo 65

Fixed | Adjustable

Product Code	Light Source Code	>CRI	CCT	LED Power	Nominal Lumen	Beam Angle (BA°)	Driver Options	Finish
<b>RJ76</b> <input checked="" type="radio"/> Fixed	<b>MC31</b> Citizen COB	<b>90</b>	<b>30</b> 3000K	6W	616 lm	<b>16 / 24 / 32</b>	<b>D0</b> No Dim	<b>10</b> <input checked="" type="checkbox"/> Black
<b>RJ77</b> <input type="radio"/> Fixed			<b>40</b> 4000K		643 lm		<b>DA</b> Dali Dim	<b>11</b> <input type="checkbox"/> White
<b>RJ29</b> <input checked="" type="radio"/> Adjustable	<b>MS61</b> Soraa SLE-11	<b>95</b>		6.7W	430 lm	<b>25 / 36</b>	<b>DP</b> Phase Dim	<b>75</b> <input checked="" type="checkbox"/> Grey
<b>RJ30</b> <input type="radio"/> Adjustable					450 lm		<b>DC</b> CASAMBI	
							<b>D1</b> 0-10V Dim	

## Ovo 90

Fixed | Adjustable

Product Code	Light Source Code	>CRI	CCT	LED Power	Nominal Lumen	Beam Angle (BA°)	Driver Options	Finish
<b>RJ68</b> <input checked="" type="radio"/> Fixed	<b>MC22</b> Citizen COB	<b>90</b>	<b>30</b> 3000K	11W	1238 lm	<b>18 / 24 / 36</b>	<b>D0</b> No Dim	<b>10</b> <input checked="" type="checkbox"/> Black
<b>RJ72</b> <input type="radio"/> Fixed			<b>40</b> 4000K		1260 lm		<b>DA</b> Dali Dim	<b>11</b> <input type="checkbox"/> White
<b>RH31</b> <input checked="" type="radio"/> Adjustable	<b>MS11</b> Soraa SLE-16	<b>95</b>		8.1W	460 lm	<b>10</b>	<b>DP</b> Phase Dim	<b>75</b> <input checked="" type="checkbox"/> Grey
<b>RJ31</b> <input type="radio"/> Adjustable				12.2W	720 lm	<b>15 / 25 / 36</b>	<b>DC</b> CASAMBI	
					755 lm		<b>D1</b> 0-10V Dim	
<b>MX22</b> Xicato Artist XTM		<b>98</b>	<b>27</b> 2700K	10.6W	700 lm	<b>16 / 28 / 38</b>		
<b>MX61</b> XIM				11.5W				
<b>MX31</b> Beauty XTM		<b>95</b>		9.5W	931 lm	<b>28 / 35 / 45</b>		
<b>MX71</b> XIM				11.5W				
<b>MX41</b> Designer XTM		<b>90</b>		11.4W	1300 lm			
<b>MX81</b> XIM				13.2W				
<b>GU53</b> Retrofit MR16-GU5.3		<b>00</b>	<b>00</b>	/	/	<b>00</b>	<b>00</b> No Driver	

## Ovo 160

Fixed | Adjustable

Product Code	Light Source Code	>CRI	CCT	LED Power	Nominal Lumen	Beam Angle (BA°)	Driver Options	Finish
<b>RJ63</b> <input checked="" type="radio"/> Fixed	<b>MC12</b> Citizen COB	<b>90</b>	<b>30</b> 3000K	33W	3220 lm	<b>12 / 22 / 32</b>	<b>D0</b> No Dim	<b>10</b> <input checked="" type="checkbox"/> Black
<b>RJ64</b> <input type="radio"/> Fixed			<b>40</b> 4000K		3300 lm		<b>DA</b> Dali Dim	<b>11</b> <input type="checkbox"/> White
<b>RJ32</b> <input checked="" type="radio"/> Adjustable	<b>MS21</b> Soraa SLE-30	<b>95</b>		16.7W	1000 lm	<b>09 / 25 / 36</b>	<b>DP</b> Phase Dim	<b>75</b> <input checked="" type="checkbox"/> Grey
<b>RJ33</b> <input type="radio"/> Adjustable					1050lm		<b>DC</b> CASAMBI	
							<b>D1</b> 0-10V Dim	

## Notes:

For other CCT options, please contact us.



# Punto

Recessed Round 76 | 100 | 167

## Fixed



## Adjustable



## Wallwasher



## Body

Round shape mounting trim in cast aluminium with springs for trim installation on a ceiling thickness of max. 25mm or brackets for trimless installation on a ceiling thickness 12.5-15mm.

Luminaire body in cast aluminium. Easy relamping tool-free via removable lamp front ring by twist and lock action.

Adjustable version tiltable vertically 0-25° tilt and rotatable horizontally 350°.

## LED sources

Citizen CLU Series. Xicato Artist, Beauty and Designer Series. SORAA SLE Optical Light Engine. CRI: 90, 95, 98 | CCT: 2700K, 3000K, 4000K. Other CRI and CCT options, Tuneable White and DimToWarm versions available on request.

## Optic

Lens. Narrow, medium and wide beam angle available.

## Accessories

Coloured filters, linear spread, honeycomb louvre, anti-glare cone, anti-glare hood. Snap System™ accessories available for SORAA SLE series with narrow beam angle.

## Finish

Powder coat in black or white colour.

## Driver

Supplied with No-dimable remote driver. Dimming Options: 0-10V Dim, DALI, Phase, CASAMBI.

## Applications

A visual simplicity seamless shape designed for excellent visual comfort versions include full directional light adjustability for maximum versatility keeping homogeneous appearance.

Application areas: retail, hotels, restaurants, hospitals, gyms.

## Related Products

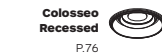
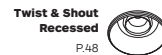

# Punto Round



## Punto 76 / 100 / 167

Fixed Round Trim

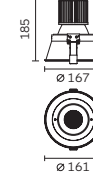
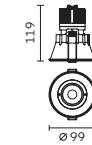

## Palla 76 / 100 / 167

Fixed Round Trimless

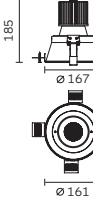
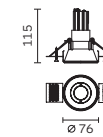
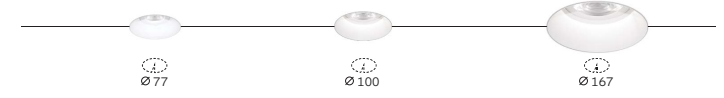

Code ordering example: **R N 2 3 M C 3 1 - 9 0 3 0 2 0 D 0 1 0**

	Product Code	Light Source Code*	>CRI	CCT	LED Power	Nominal Lumen	Beam Angle (00°)	Driver Options	Finish
Punto 76	<b>RN23</b>	<b>MC31</b>	<b>90</b>	<b>30</b> 3000K	6W	616 lm	<b>20 / 30 / 40</b>	<b>D0</b> No Dim	<b>10</b> Black
Fixed Round	<b>RN24</b>			<b>40</b> 4000K		643 lm		<b>DA</b> Dali Dim	<b>11</b> White
Punto 100	<b>RA05</b>	<b>MC22</b>			10W	1276 lm	<b>18 / 24 / 36</b>	<b>DP</b> Phase Dim	
Fixed Round	<b>RA06</b>					1296 lm		<b>DC</b> CASAMBI	
Punto 167	<b>RH13</b>	<b>MC33</b>			33W	3220 lm	<b>12 / 22 / 32</b>	<b>D1</b> 0-10V Dim	
Fixed Round	<b>RH14</b>					3300 lm			

## Notes:

\* For complete code ordering information, please see page 377.

\*\* For other CCT options, please contact us.

For related accessories, please see page 105.

# Punto Round



**Punto 100**  
Adjustable Round Trim

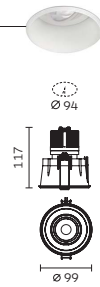

**Punto 100**  
Adjustable Round Trimless

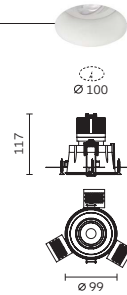

Code ordering example: **RF55 MC22-90 30 18 D0 10**

	Product Code	Light Source Code*	>CRI	CCT**	LED Power	Nominal Lumen	Beam Angle (BA°)	Driver Options	Finish
Punto 100 Adjustable Round	<b>RF55</b> <input checked="" type="radio"/>	<b>MC22</b>	<b>90</b>	<b>30</b> 3000K	10W	1276 lm	<b>18 / 24 / 36</b>	<b>D0</b> No Dim	<b>10</b> <input checked="" type="checkbox"/> Black
	<b>RF56</b> <input type="radio"/>			<b>40</b> 4000K		1296 lm		<b>DA</b> Dali Dim	<b>11</b> <input type="checkbox"/> White
								<b>DP</b> Phase Dim	
								<b>DC</b> CASAMBI	
								<b>D1</b> 0-10V Dim	

**Notes:**  
 \* For complete code ordering information, please see page 377.  
 \*\* For other CCT options, please contact us.  
 For related accessories, please see page 105.

# Punto Round



**Punto 100 / 167**  
Wallwasher Round Trim

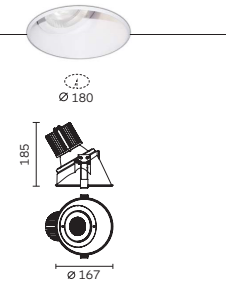
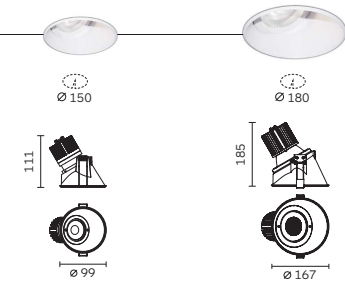

**Punto 100 / 167**  
Wallwasher Round Trimless

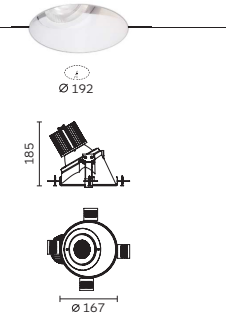

Code ordering example: **RA07 MC22-90 30 WW D0 10**

	Product Code	Light Source Code*	>CRI	CCT**	LED Power	Nominal Lumen	Beam Angle (BA°)	Driver Options	Finish
Punto 100 Wallwasher Round	<b>RA07</b> <input checked="" type="radio"/>	<b>MC22</b>	<b>90</b>	<b>30</b> 3000K	10W	1276 lm	<b>WW</b>	<b>D0</b> No Dim	<b>10</b> <input checked="" type="checkbox"/> Black
	<b>RA08</b> <input type="radio"/>			<b>40</b> 4000K		1296 lm		<b>DA</b> Dali Dim	<b>11</b> <input type="checkbox"/> White
Punto 167 Wallwasher Round	<b>RH15</b> <input checked="" type="radio"/>	<b>MC33</b>			33W	3220 lm		<b>DP</b> Phase Dim	
	<b>RH16</b> <input type="radio"/>					3300 lm		<b>DC</b> CASAMBI	
								<b>D1</b> 0-10V Dim	

**Notes:**  
 \* For complete code ordering information, please see page 377.  
 \*\* For other CCT options, please contact us.  
 For related accessories, please see page 105.

# Punto

Recessed Square 76 | 100 | 167

## Fixed



## Adjustable



## Wallwasher



## Body

Square shape mounting trim in cast aluminium with springs for trim installation on a ceiling thickness of max. 25mm or brackets for trimless installation on a ceiling thickness 12.5-15mm.

Luminaire body in cast aluminium. Easy relamping tool-free via removable lamp front ring by twist and lock action.

Adjustable version tiltable vertically 0-25° tilt and rotatable horizontally 350°.

## LED sources

Citizen CLU Series. Xicato Artist, Beauty and Designer Series. SORAA SLE Optical Light Engine. CRI: 90, 95, 98 | CCT: 2700K, 3000K, 4000K. Other CRI and CCT options, Tuneable White and DimToWarm versions available on request.

## Optic

Lens.  
Narrow, medium and wide beam angle available.

## Accessories

Coloured filters, linear spread, honeycomb louvre, anti-glare cone, anti-glare hood.  
Snap System™ accessories available for SORAA SLE series with narrow beam angle.

## Finish

Powder coat in black or white colour.

## Driver

Supplied with No-dimable remote driver.  
Dimming Options: 0-10V Dim, DALI, Phase, CASAMBI.

## Applications

A visual simplicity seamless shape designed for excellent visual comfort versions include full directional light adjustability for maximum versatility keeping homogeneous appearance.

Application areas: retail, hotels, restaurants, hospitals, gyms.

## Related Products



# Punto Square



## Punto 76 / 100 / 167

Fixed Square Trim

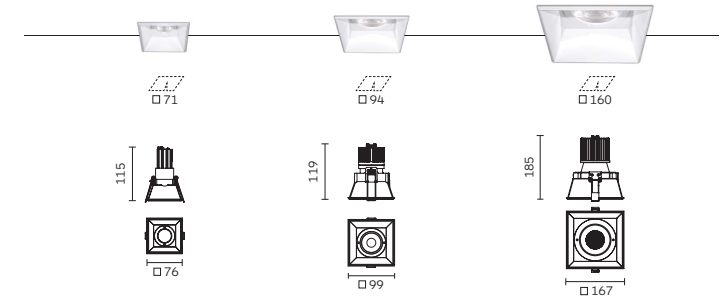

## Punto 70 / 100 / 130

Fixed Square Trimless

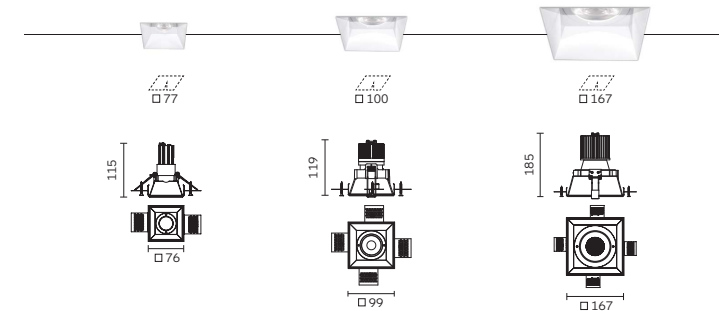

Code ordering example: **R N 2 5 M C 3 1 - 9 0 3 0 2 0 D 0 1 0**

	Product Code	Light Source Code*	>CRI	CCT**	LED Power	Nominal Lumen	Beam Angle (BA°)	Driver Options	Finish
Punto 76	<b>RN25</b>	<b>MC31</b>	<b>90</b>	<b>30</b> 3000K	6W	616 lm	<b>20 / 30 / 40</b>	<b>D0</b> No Dim	<b>10</b> Black
Fixed Square	<b>RN26</b>			<b>40</b> 4000K		643 lm		<b>DA</b> Dali Dim	<b>11</b> White
Punto 100	<b>RA09</b>	<b>MC22</b>			10W	1276 lm	<b>18 / 24 / 36</b>	<b>DP</b> Phase Dim	
Fixed Square	<b>RA10</b>					1296 lm		<b>DC</b> CASAMBI	
Punto 167	<b>RH17</b>	<b>MC33</b>			33W	3220 lm	<b>12 / 22 / 32</b>	<b>D1</b> 0-10V Dim	
Fixed Square	<b>RH18</b>					3300 lm			

## Notes:

\* For complete code ordering information, please see page 377.

\*\* For other CCT options, please contact us.

For related accessories, please see page 105.

## Punto Square



### Punto 100

Adjustable Square Trim

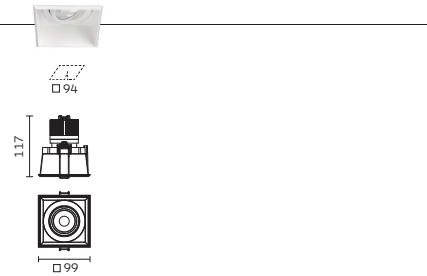

### Punto 100

Adjustable Square Trimless

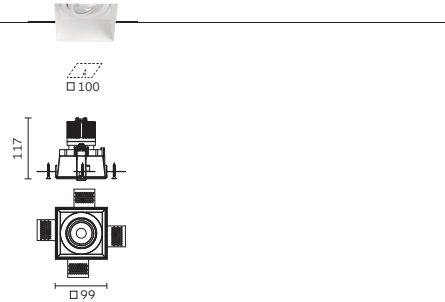

Code ordering example: **R F 5 7 M C 2 2 - 9 0 3 0 1 8 D 0 1 0**

	Product Code	Light Source Code*	>CRI	CCT**	LED Power	Nominal Lumen	Beam Angle (BA°)	Driver Options	Finish
Punto 100 Adjustable Square	<b>RF57</b> <input checked="" type="checkbox"/>	<b>MC22</b>	<b>90</b>	<b>30</b> 3000K	10W	1276 lm	<b>18 / 24 / 36</b>	<b>D0</b> No Dim	<b>10</b> <input checked="" type="checkbox"/> Black
	<b>RF58</b> <input type="checkbox"/>			<b>40</b> 4000K		1296 lm		<b>DA</b> Dali Dim	<b>11</b> <input type="checkbox"/> White
								<b>DP</b> Phase Dim	
								<b>DC</b> CASAMBI	
								<b>D1</b> 0-10V Dim	

#### Notes:

\* For complete code ordering information, please see page 377.  
 \*\* For other CCT options, please contact us.  
 For related accessories, please see page 105.

## Punto Square



### Punto 100 / 167

Wallwasher Square Trim

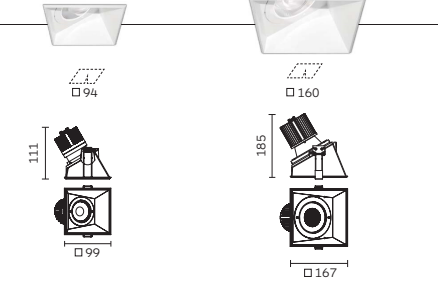

### Punto 100 / 167

Wallwasher Square Trimless

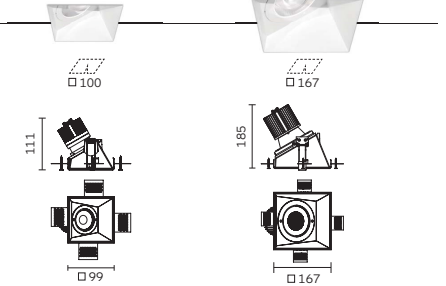

Code ordering example: **R A 1 1 M C 2 2 - 9 0 3 0 WW D 0 1 0**

	Product Code	Light Source Code*	>CRI	CCT**	LED Power	Nominal Lumen	Beam Angle (BA°)	Driver Options	Finish
Punto 100 Wallwasher Square	<b>RA11</b> <input checked="" type="checkbox"/>	<b>MC22</b>	<b>90</b>	<b>30</b> 3000K	10W	1276 lm	<b>WW</b>	<b>D0</b> No Dim	<b>10</b> <input checked="" type="checkbox"/> Black
	<b>RA12</b> <input type="checkbox"/>			<b>40</b> 4000K		1296 lm		<b>DA</b> Dali Dim	<b>11</b> <input type="checkbox"/> White
								<b>DP</b> Phase Dim	
								<b>DC</b> CASAMBI	
								<b>D1</b> 0-10V Dim	
Punto 167 Wallwasher Square	<b>RH19</b> <input checked="" type="checkbox"/>	<b>MC33</b>			33W	3220 lm			
	<b>RH20</b> <input type="checkbox"/>					3300 lm			

#### Notes:

\* For complete code ordering information, please see page 377.  
 \*\* For other CCT options, please contact us.  
 For related accessories, please see page 105.

## Punto Recessed Family configuration options

Code ordering example: R N 2 3 M C 3 1 - 9 0 3 0 2 0 0 1 0

### Punto 76 Round & Square

Fixed

Product code	Light source code	>CRI	CCT	LED Power	Nominal lumen	Beam angle (BA°)	Driver Options	Finish
<b>RN23</b> <input checked="" type="checkbox"/> Fixed	<b>MC31</b> Citizen COB	<b>90</b>	<b>30</b> 3000K	6W	616 lm	<b>20 / 30 / 40</b>	<b>DO</b> No Dim	<b>10</b> <input checked="" type="checkbox"/> Black
<b>RN24</b> <input type="checkbox"/> Fixed			<b>40</b> 4000K		643 lm		<b>DA</b> Dali Dim	<b>11</b> <input type="checkbox"/> White
<b>RN25</b> <input checked="" type="checkbox"/> Fixed	<b>MS61</b> Soraa SLE-11	<b>95</b>		6.7W	430 lm	<b>25 / 36</b>	<b>DP</b> Phase Dim	
<b>RN26</b> <input type="checkbox"/> Fixed					450 lm		<b>DC</b> CASAMBI	
							<b>D1</b> 0-10V Dim	
	<b>GU04</b> Retrofit GU4	<b>00</b>	<b>00</b>	/	/	<b>00</b>	<b>00</b> No Driver	

### Punto 100 Round & Square

Fixed | Adjustable | Wallwasher

Product code	Light source code	>CRI	CCT	LED Power	Nominal lumen	Beam angle (BA°)	Driver Options	Finish
<b>RA05</b> <input checked="" type="checkbox"/> Fixed	<b>MC22</b> Citizen COB	<b>90</b>	<b>30</b> 3000K	10W	1276 lm	<b>18 / 24 / 36</b>	<b>DO</b> No Dim	<b>10</b> <input checked="" type="checkbox"/> Black
<b>RA06</b> <input type="checkbox"/> Fixed			<b>40</b> 4000K		1296 lm		<b>DA</b> Dali Dim	<b>11</b> <input type="checkbox"/> White
<b>RA09</b> <input checked="" type="checkbox"/> Fixed	<b>MS11</b> Soraa SLE-16	<b>95</b>		8.3W	460 lm	<b>10</b>	<b>DP</b> Phase Dim	
<b>RA10</b> <input type="checkbox"/> Fixed					480 lm		<b>DC</b> CASAMBI	
<b>RF55</b> <input checked="" type="checkbox"/> Adjustable				12.2W	720 lm	<b>15 / 25 / 36</b>	<b>D1</b> 0-10V Dim	
<b>RF56</b> <input type="checkbox"/> Adjustable					755lm			
<b>RF57</b> <input checked="" type="checkbox"/> Adjustable	<b>MX22</b> Xicato Artist XTM	<b>98</b>	<b>27</b> 2700K	10.6W	700 lm	<b>16 / 28 / 38</b>		
<b>RF58</b> <input type="checkbox"/> Adjustable	<b>MX61</b>				11.5W			
<b>RA07</b> <input checked="" type="checkbox"/> Wallwasher	<b>MX31</b> Beauty XTM	<b>95</b>		9.5W	931 lm	<b>28 / 35 / 45</b>		
<b>RA08</b> <input type="checkbox"/> Wallwasher	<b>MX71</b>				11.5W			
<b>RA11</b> <input checked="" type="checkbox"/> Wallwasher	<b>MX41</b> Designer XTM	<b>90</b>		11.4W	1300 lm			
<b>RA12</b> <input type="checkbox"/> Wallwasher	<b>MX81</b>				13.2W			
	<b>GU53</b> Retrofit MR16-GU5.3	<b>00</b>	<b>00</b>	/	/	<b>00</b>	<b>00</b> No Driver	
	<b>GU10</b> GZ10-GU10							

### Punto 167 Round & Square

Fixed | Wallwasher

Product code	Light source code	>CRI	CCT	LED Power	Nominal lumen	Beam angle (BA°)	Driver Options	Finish
<b>RH13</b> <input checked="" type="checkbox"/> Fixed	<b>MC33</b> Citizen COB	<b>90</b>	<b>30</b> 3000K	33W	3220 lm	<b>12 / 22 / 32</b>	<b>DO</b> No Dim	<b>10</b> <input checked="" type="checkbox"/> Black
<b>RH14</b> <input type="checkbox"/> Fixed			<b>40</b> 4000K		3300 lm		<b>DA</b> Dali Dim	<b>11</b> <input type="checkbox"/> White
<b>RH17</b> <input checked="" type="checkbox"/> Fixed	<b>BS22</b> Soraa SLE-30	<b>95</b>		20W	1200 lm	<b>09 / 25 / 35</b>	<b>DP</b> Phase Dim	
<b>RH18</b> <input type="checkbox"/> Fixed					1300 lm		<b>DC</b> CASAMBI	
<b>RH15</b> <input checked="" type="checkbox"/> Wallwasher	<b>MX25</b> Xicato Artist XTM	<b>98</b>	<b>27</b> 2700K	20W	2000 lm	<b>25 / 36 / 45</b>	<b>D1</b> 0-10V Dim	
<b>RH16</b> <input type="checkbox"/> Wallwasher	<b>MX32</b> Beauty XTM	<b>95</b>						
<b>RH19</b> <input checked="" type="checkbox"/> Wallwasher	<b>MX43</b> Designer XTM	<b>90</b>		25.7W	3000 lm			
<b>RH20</b> <input type="checkbox"/> Wallwasher	<b>AR111</b> Retrofit AR111	<b>00</b>	<b>00</b>	/	/	<b>00</b>	<b>00</b> No Driver	

#### Notes:

For other CCT options, please contact us.

## Optical Accessories

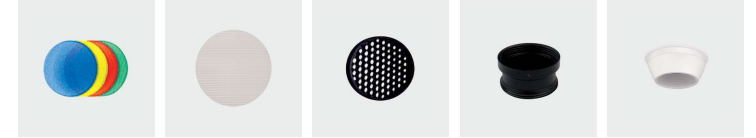

Product / Optical Accessories	Coloured Filters Colours 25, 42, 55, 85	Linear Spread Colour 41	Honeycomb Louvre Colour 10	Anti-Glare Cone Colour 10	Snoot Colours 10, 17
Punto 76 Round & Square	/	/	/	/	/
Punto 100 Round & Square	<b>2614*</b>	<b>2615</b>	<b>2504</b>	<b>2661</b>	<b>2675</b>
Punto 167 Round & Square	<b>2599*</b>	<b>2598</b>	<b>2334</b>	/	<b>2327</b>

\*With holder

For Soraa specific accessories, please contact us and we will provide the detailed information.

# Micron

Recessed



## Body

Round shape mounting trim in cast aluminium with springs for trim installation on a ceiling thickness max. 20mm.

Luminaire body in cast aluminium and fixing ring in steel. Fixing ring can be installed independently. Easy relamping via removable light head by snap-in catch action. Available in IP20/IP54 versions.

Rotable horizontally 350°. **IP20:** tiltable vertically 0-35°. **IP54:** tiltable vertically 0-30°.

## LED sources

Citizen CLU Series.  
CRI: 90 | CCT: 3000K, 4000K.  
Other CRI and CCT options, Tuneable White and DimToWarm versions available on request.

## Optic

Reflector + Diffuser.  
Narrow, medium and wide beam angle available.

## Accessories

No accessories available.

## Finish

Powder coat in black or white colour.

## Driver

Supplied with No-dimable remote driver.  
Dimming Options: 0-10V Dim, DALI, Phase, CASAMBI.

## Applications

A concealed light source for minimum glare design of small aperture recessed luminaries that easily blend into the architecture to meet the need of designers.  
Application areas: retail, showrooms, residential, restaurants, hotels.

## Related Products

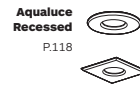

# Micron



**Micron**  
Adjustable

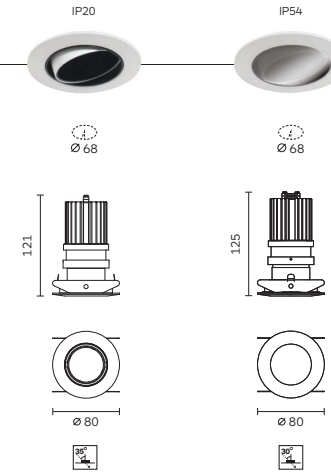

Code ordering example: **R L 5 9 M C 2 2 - 9 0 3 0 1 8 D 0 1 0**

	Product Code	Ingress Protection	Light Source Code*	>CRI	CCT**	LED Power	Nominal Lumen	Beam Angle (BA°)	Driver Options	Finish
Micron Adjustable	<b>RL59</b>	IP20	<b>MC22</b> Citizen COB	<b>90</b>	<b>30</b> 3000K	11W	1238 lm	<b>18 / 24 / 36</b>	<b>D0</b> No Dim	<b>10</b> Black
	<b>RL60</b>	IP54			<b>40</b> 4000K		1260 lm		<b>DA</b> Dali Dim <b>DP</b> Phase Dim <b>DC</b> CASAMBI <b>D1</b> 0-10V Dim	<b>11</b> White
	<b>GU53</b> Retrofit GU5.3			<b>00</b>	<b>00</b>	/	/	<b>00</b>	<b>00</b> No Driver	

## Notes:

\* For complete code ordering information, please see page 377.

\*\* For other CCT options, please contact us.

# Nippo

Recessed Round & Square



## Body

Round or square shape mounting trim in cast aluminium with springs for trim installation on a ceiling thickness max. 25mm.

Luminaire body in cast aluminium inclusive of dark light cone reflector in super pure aluminium. Designed for optimum heat dissipation. Easy relamping via removable front reflector and by twist-lock action.

Tilttable vertically 0-30° and rotatable horizontally 350°.

## Accessories

Coloured filters, linear spread and honeycomb louver. Snap System™ accessories available for SORAA SLC series with narrow beam angle.

## Finish

Powder coat in white or grey colour.

## LED sources

Citizen CLU Series. Xicato Artist, Beauty and Designer Series. SORAA SLE Optical Light Engine. CRI: 90, 95, 98 | CCT: 2700K, 3000K, 4000K. Other CRI and CCT options, Tuneable White and DimToWarm versions available on request.

## Optic

Inner reflector with diffuser and dark light secondary reflector. Narrow, medium and wide beam angle available.

## Driver

Supplied with No-dimable remote driver. Dimming Options: 0-10V Dim, DALI, Phase, CASAMBI.

## Applications

Adjustable fixture include a specular darklight cone reflector offering excellent glare-free visual comfort to minimize impact while piercing through ambient light levels. Application areas: hotels, residential, retail, galleries.

### Related Products



# Nippo Round



Nippo  
Round



Ø 78

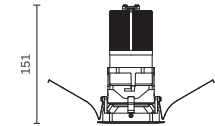

Code ordering example: **R J 1 1 M C 2 2 - 9 0 3 0 1 6 D 0 1 1**

	Product Code	Ingress Protection	Light Source Code*	>CRI	CCT**	LED Power	Nominal Lumen	Beam Angle (BA°)	Driver Options	Finish
Nippo Round	<b>RJ11</b>	IP20	<b>MC22</b>	<b>90</b>	<b>30</b> 3000K	12W	1492 lm	<b>16 / 26</b>	<b>D0</b> No Dim	<b>11</b> White
	<b>RL54</b>	IP44			<b>40</b> 4000K		1515 lm		<b>DA</b> Dali Dim	<b>75</b> Grey
									<b>DP</b> Phase Dim	
									<b>DC</b> CASAMBI	
									<b>D1</b> 0-10V Dim	

### Notes:

\* For complete code ordering information, please see page 377.

\*\* For other CCT options, please contact us.

For related accessories, please see page 111.

# Nippo Square



Nippo  
Square

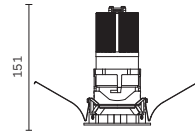

Code ordering example: R L 4 8 M C 2 2 - 9 0 3 0 1 6 D 0 1 1

	Product Code	Ingress Protection	Light Source Code*	>CRI	CCT**	LED Power	Nominal Lumen	Beam Angle (BA°)	Driver Options	Finish
Nippo Square	<b>RL48</b> <input type="checkbox"/>	IP20	<b>MC22</b>	<b>90</b>	<b>30</b> 3000K	12W	1492 lm	<b>16 / 26</b>	<b>D0</b> No Dim	<b>11</b> <input type="checkbox"/> White
	<b>RL55</b> <input type="checkbox"/>	IP44			<b>40</b> 4000K		1515 lm		<b>DA</b> Dali Dim <b>DP</b> Phase Dim <b>DC</b> CASAMBI <b>D1</b> 0-10V Dim	<b>75</b> <input type="checkbox"/> Grey

**Notes:**  
 \* For complete code ordering information, please see page 377.  
 \*\* For other CCT options, please contact us.  
 For related accessories, please see page 111.

# Nippo Recessed Family configuration options

Code ordering example: R J 1 1 M C 2 2 - 9 0 3 0 1 6 D 0 1 1

## Nippo Round & Square

Product Code	Ingress Protection	Light Source Code	>CRI	CCT	LED Power	Nominal Lumen	Beam Angle (BA°)	Driver Options	Finish
<b>RJ11</b> <input type="checkbox"/>	IP20	<b>MC22</b> Citizen COB	<b>90</b>	<b>30</b> 3000K	12W	1492 lm	<b>16 / 26</b>	<b>D0</b> No Dim	<b>11</b> <input type="checkbox"/> White
<b>RL54</b> <input type="checkbox"/>	IP44			<b>40</b> 4000K		1515 lm		<b>DA</b> Dali Dim	<b>75</b> <input type="checkbox"/> Grey
<b>RL48</b> <input type="checkbox"/>	IP20	<b>MS11</b> Soraa SLE-16	<b>95</b>		8.1W	460 lm	<b>10</b>	<b>DP</b> Phase Dim	<b>DC</b> CASAMBI
<b>RL55</b> <input type="checkbox"/>	IP44				12.2W	480 lm		<b>DC</b> CASAMBI	<b>D1</b> 0-10V Dim
						755 lm			
		<b>MX22</b> Xicato Artist XTM	<b>98</b>	<b>27</b> 2700K	10.6W	700 lm	<b>16 / 28 / 38</b>		
		<b>MX61</b> XIM			11.5W				
		<b>MX31</b> Beauty XTM	<b>95</b>		9.5W	931 lm	<b>28 / 35 / 45</b>		
		<b>MX71</b> XIM			11.5W				
		<b>MX41</b> Designer XTM	<b>90</b>		11.4W	1300 lm			
		<b>MX81</b> XIM			13.2W				
IP20	<b>GU53</b> Retrofit	MR16-GU5.3	<b>00</b>	<b>00</b>	/	/	<b>00</b>	<b>00</b> No Driver	

## Optical Accessories

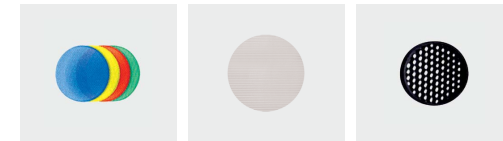

Product / Optical Accessories	Coloured Filters Colours 25, 42, 55, 85	Linear Spread Colour 41	Honeycomb Louvre Colour 10
Nippo Round & Square	<b>2662*</b>	<b>2663</b>	<b>2634</b>

\* With holder  
 For Soraa specific accessories, please contact us and we will provide the detailed information.

**Notes:**  
 For other CCT options, please contact us.



# Occhio

Recessed 65 | 87

## Pin Fixed



## Pin Adjustable



## Slot Adjustable



## Body

Round shape mounting trim in cast aluminium with brackets for trim installation on a ceiling thickness max. 20mm.

Luminaire body in cast aluminium. Available in two different designs, Pin and Slot. IP44 version for water protection ideal for bathroom. Designed with deep regressed lamp position for glare-free comfort.

Adjustable version tiltable vertically 0-30°.

## LED sources

Citizen CLU Series. Xicato Artist, Beauty and Designer Series. SORAA SLE Optical Light Engine. CRI: 90, 95, 98 | CCT: 2700K, 3000K, 4000K. Other CRI and CCT options, Tuneable White and DimToWarm versions available on request.

## Optic

Reflector. Narrow, medium and wide beam angle available.

## Accessories

Coloured filter, linear spread, honeycomb louvre, ceiling ring. Snap System™ accessories available for SORAA SLC series with narrow beam angle.

## Finish

Powder coat in white colour.

## Driver

Supplied with No-dimable remote driver. Dimming Options: 0-10V Dim, DALI, Phase, CASAMBI.

## Applications

Outstanding lighting fixture. Occhio Pin provides a consistent ceiling appearance whilst the Occhio Slot provides the maximum adjustment in this type of small fixture. Application areas: bathrooms, residential, museums, retail, hotels.

## Related Products

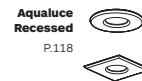
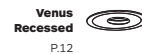

# Occhio Pin

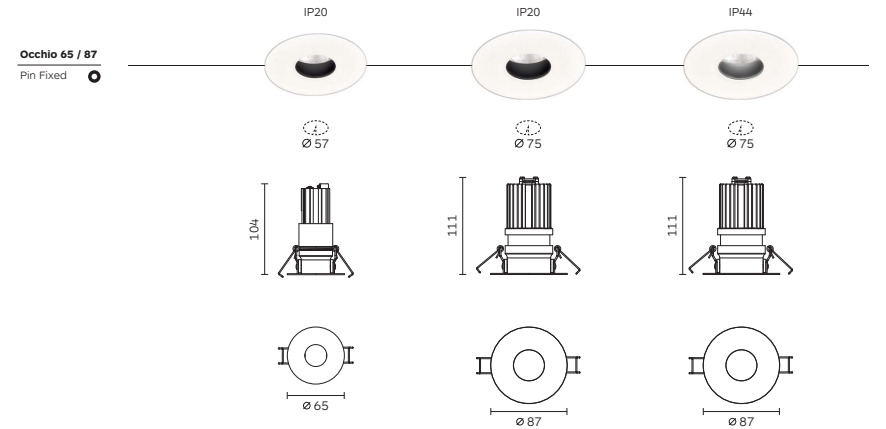

Occhio 65 / 87  
Pin Fixed ○



Code ordering example: **R N 5 7 M C 3 1 - 9 0 3 0 1 6 D 0 1 1**

	Product Code	Ingress Protection	Light Source Code*	>CRI	CCT**	LED Power	Nominal Lumen	Beam Angle (BA°)	Driver Options	Finish
Occhio 65	<b>RN57</b> ○	IP20	<b>MC31</b>	<b>90</b>	<b>30</b> 3000K	6W	616 lm	<b>16 / 30</b>	<b>DO</b> No Dim	<b>11</b> □ White
Pin Fixed					<b>40</b> 4000K		643 lm		<b>DA</b> Dali Dim	
Occhio 87	<b>RK96</b> ○	IP20	<b>MC22</b>			11W	1238 lm	<b>18 / 24 / 36</b>	<b>DP</b> Phase Dim	
Pin Fixed	<b>RL38</b> ○	IP44					1260 lm		<b>DC</b> CASAMBI	
									<b>D1</b> 0-10V Dim	

### Notes:

\* For complete code ordering information, please see page 377.  
\*\* For other CCT options, please contact us.  
For related accessories, please see page 117.

# Occhio Pin



Occhio 65 / 87  
Pin Adjustable

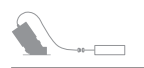
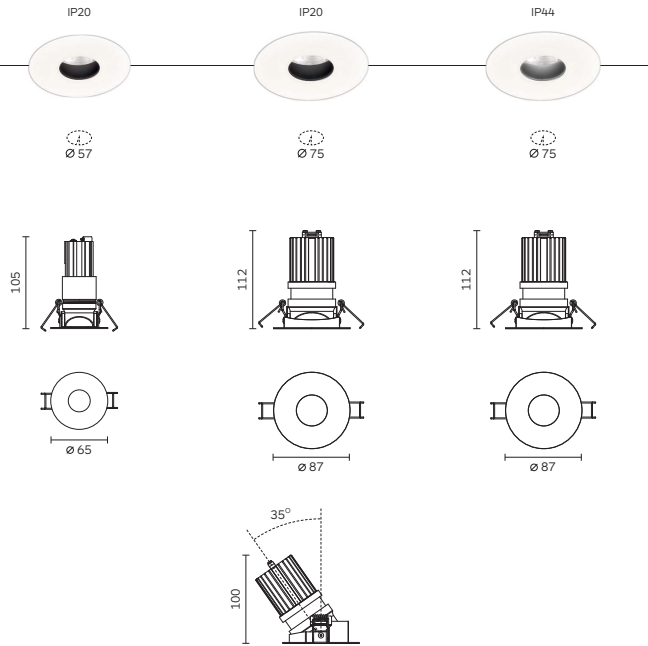

Code ordering example: **R N 5 8 M C 3 1 - 9 0 3 0 1 6 D 0 1 1**

	Product Code	Ingress Protection	Light Source Code*	>CRI	CCT**	LED Power	Nominal Lumen	Beam Angle (BA°)	Driver Options	Finish
Occhio 65 Pin Adjustable	<b>RN58</b> <input checked="" type="radio"/>	IP20	<b>MC31</b>	<b>90</b>	<b>30</b> 3000K	6W	616 lm	<b>16 / 30</b>	<b>D0</b> No Dim	<b>11</b> <input type="checkbox"/> White
					<b>40</b> 4000K		643 lm	<b>DA</b> Dali Dim		
Occhio 87 Pin Adjustable	<b>RL01</b> <input checked="" type="radio"/>	IP20	<b>MC22</b>		11W	1238 lm	<b>18 / 24 / 36</b>	<b>DP</b> Phase Dim		
				<b>RL42</b> <input checked="" type="radio"/>	IP44		1260 lm	<b>DC</b> CASAMBI	<b>D1</b> 0-10V Dim	

**Notes:**  
\* For complete code ordering information, please see page 377.  
\*\* For other CCT options, please contact us.  
For related accessories, please see page 117.

# Occhio Slot



Occhio 65 / 87  
Slot Adjustable

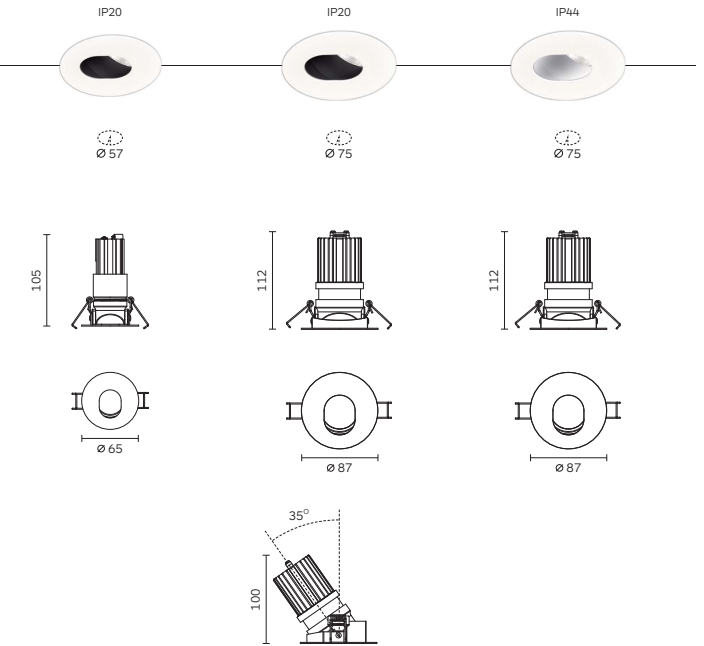

Code ordering example: **R N 5 6 M C 3 1 - 9 0 3 0 1 6 D 0 1 1**

	Product Code	Ingress Protection	Light Source Code*	>CRI	CCT**	LED Power	Nominal Lumen	Beam Angle (BA°)	Driver Options	Finish
Occhio 65 Slot Adjustable	<b>RN56</b> <input checked="" type="radio"/>	IP20	<b>MC31</b>	<b>90</b>	<b>30</b> 3000K	6W	616 lm	<b>16 / 30</b>	<b>D0</b> No Dim	<b>11</b> <input type="checkbox"/> White
					<b>40</b> 4000K		643 lm	<b>DA</b> Dali Dim		
Occhio 87 Slot Adjustable	<b>RL05</b> <input checked="" type="radio"/>	IP20	<b>MC22</b>		11W	1238 lm	<b>18 / 24 / 36</b>	<b>DP</b> Phase Dim		
				<b>RL46</b> <input checked="" type="radio"/>	IP44		1260 lm	<b>DC</b> CASAMBI	<b>D1</b> 0-10V Dim	



**Notes:**  
\* For complete code ordering information, please see page 377.  
\*\* For other CCT options, please contact us.  
For related accessories, please see page 117.

## Occhio Recessed Family configuration options

Code ordering example: R N 5 7 M C 3 1 - 9 0 3 0 1 6 D 0 1 1







### Occhio 65 Round

Pin Fixed | Pin Adjustable | Slot Adjustable

Product Code	Ingress Protection	Light Source Code	>CRI	CCT	LED Power	Nominal Lumen	Beam Angle (BA°)	Driver Options	Finish
<b>RN57</b>  Pin Fixed	IP20	<b>MC31</b> Citizen COB	<b>90</b>	<b>30</b> 3000K	6W	616 lm	<b>16 / 30</b>	<b>D0</b> No Dim	<b>11</b> <input type="checkbox"/> White
<b>RN58</b>  Pin Adjustable	IP20			<b>40</b> 4000K		643 lm		<b>DA</b> Dali Dim	
<b>RN56</b>  Slot Adjustable	IP20	<b>MS61</b> Soraa SLE-11	<b>95</b>		6.7W	430 lm 450 lm	<b>25 / 36</b>	<b>DP</b> Phase Dim <b>DC</b> CASAMBI <b>D1</b> 0-10V Dim	
<b>GU04</b> Retrofit	GU4		<b>00</b>	<b>00</b>	/	/	<b>00</b>	<b>00</b> No Driver	

### Occhio 87 Round

Pin Fixed | Pin Adjustable | Slot Adjustable

Product Code	Ingress Protection	Light Source Code	>CRI	CCT	LED Power	Nominal Lumen	Beam Angle (BA°)	Driver Options	Finish
<b>RK96</b>  Pin Fixed	IP20	<b>MC22</b> Citizen COB	<b>90</b>	<b>30</b> 3000K	11W	1238 lm	<b>18 / 24 / 36</b>	<b>D0</b> No Dim	<b>11</b> <input type="checkbox"/> White
<b>RL38</b>  Pin Fixed	IP44			<b>40</b> 4000K		1260 lm		<b>DA</b> Dali Dim	
<b>RL01</b>  Pin Adjustable	IP20	<b>MS11</b> Soraa SLE-16	<b>95</b>		8.1W	460 lm	<b>10</b>	<b>DP</b> Phase Dim	
<b>RL42</b>  Pin Adjustable	IP44					480 lm		<b>DC</b> CASAMBI	
<b>RL05</b>  Slot Adjustable	IP20				12.2W	720 lm	<b>15 / 25 / 36</b>	<b>D1</b> 0-10V Dim	
<b>RL46</b>  Slot Adjustable	IP44					755 lm			
<b>MX22</b> Xicato Artist XTM			<b>98</b>	<b>27</b> 2700K	10.6W	700 lm	<b>16 / 28 / 38</b>		
<b>MX61</b>					11.5W				
<b>MX31</b> Beauty XTM			<b>95</b>		9.5W	931 lm	<b>28 / 35 / 45</b>		
<b>MX71</b>					11.5W				
<b>MX41</b> Designer XTM			<b>90</b>		11.4W	1300 lm			
<b>MX81</b>					13.2W				
<b>GU53</b> Retrofit	MR16-GU5.3		<b>00</b>	<b>00</b>	/	/	<b>00</b>	<b>00</b> No Driver	
<b>GU10</b>	GZ10-GU10								

#### Notes:

For other CCT options, please contact us.

## Optical Accessories

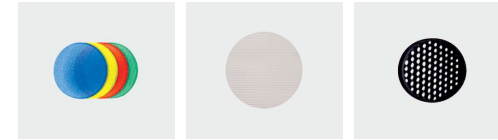

Product / Optical Accessories

Coloured Filters  
Colours 25, 42, 55, 85

Linear Spread  
Colour 41

Honeycomb Louvre  
Colour 10

Occhio 87 Round

**2614\***

**2615**

**2504**

\* With holder

For Soraa specific accessories, please contact us and we will provide the detailed information.

# Aqualuce

Recessed



## Body

Round shape mounting trim in cast aluminium with springs for trim installation on a ceiling thickness max. 20mm. Trim equipped with silicone water seal.

Independent light body in steel. IP54 (protection against dust and water) fixture. Easy relamping via removable front ring by snap-in catch action.

## LED sources

GU5.3-MR16 and GU10-MR16.  
CRI/CCT: according with the chosen lamp holder.

## Optic

Light source not included.

## Related Products

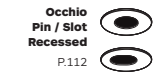

## Accessories

No accessories available.

## Driver

Supplied with No driver.  
Dimming Options: 0-10V Dim, DALI, Phase, CASAMBI.

## Finish

Powder coat in white or chrome polished colour.

## Applications

An ideal lighting system for areas with water splashes or where condensation occurs.  
Application areas: bathrooms, gyms, saunas, spas, residential, retail, under canopy areas.

# Aqualuce Round & Square



Aqualuce  
Round & Square

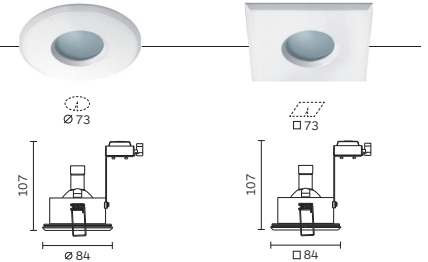

## Bathroom Light Installation Guide \*

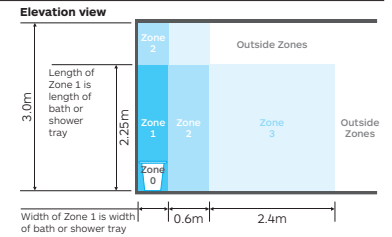
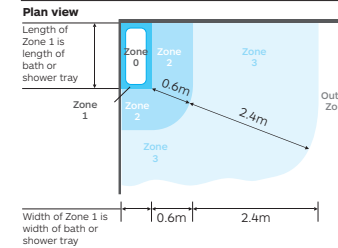

Code ordering example: **RE47 GU53-000000010**

Product Code	Light Source Code*	>CRI	CCT**	LED Power	Nominal Lumen	Beam Angle (BA°)	Driver Options	Finish
Aqualuce Round	<b>RE47</b> <b>GU53</b> Retrofit MR16-GU5.3	<b>00</b>	<b>00</b>	/	/	<b>00</b>	<b>00</b> No Driver	<b>10</b> Black
	<b>GU10</b> Retrofit GZ10-GU10							<b>11</b> White
Aqualuce Square	<b>RE48</b>							

## Notes:

- \* For complete code ordering information, please see page 377.
- \*\* For other CCT options, please contact us.
- \* Bathroom lights must be installed in accordance with IEE regulations. Forma's IP44 shower range can be installed in zones 1, 2, 3.

# Comforto

Recessed 77

Fixed & Wallwasher



## Body

Round mounting trim in cast aluminium with clamps for trim installation on a ceiling thickness of max. 30mm.

Luminaire body and front ring in cast aluminium with integrated superpure aluminium reflector.

Exchangable front ring available in different colour.

## LED sources

Citizen CLU Series.  
CRI: 90 | CCT: 3000K, 4000K.  
Other CRI and CCT options available on request.

## Optic

Downlight UGR < 13.  
Narrow, medium and wide beam angle available.

## Accessories

No accessories available.

## Finish

Powder coat in white colour.

## Driver

Supplied with No-dimable remote driver.  
Dimming Options: 0-10V Dim, DALI, Phase, CASAMBI.

## Applications

A visual simplicity seamless shape designed for excellent visual comfort keeping homogeneous appearance.  
Wallwasher ideal for highlighting the upper part of wall.  
Application areas: Retail, hotels, hospitals, restaurants.

## Related Products

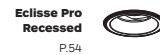

# Comforto



Comforto 77

Fixed



Ø 68

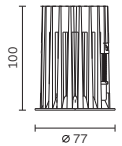

Comforto 77

Wallwasher



Ø 68

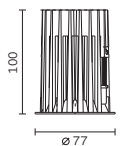

Code ordering example: **RL85BC22-903018D011**

	Product Code	Light Source Code*	>CRI	CCT**	LED Power	Nominal Lumen	Beam Angle (BA°)	Driver Options	Finish
Comforto 77 Fixed	<b>RL85</b>	<b>BC22</b> Citizen COB	<b>90</b>	<b>30</b> 3000K	12W	1498 lm	<b>18 / 40</b>	<b>D0</b> No Dim	<b>11</b> White
Comforto 77 Wallwasher	<b>RL86</b>			<b>40</b> 4000K		1522 lm	<b>WW</b>	<b>DP</b> Phase Dim <b>DC</b> CASAMBI <b>D1</b> 0-10V Dim	

## Notes:

\* For complete code ordering information, please see page 377.

\*\* For other CCT options, please contact us.

# Galaxis Pro

Recessed 165 | 200 | 230



## Body

Round mounting trim in cast aluminium with springs for trim installation on a ceiling thickness of max. 25mm.

Luminaire body and heat dissipator for passive cooling in cast aluminium. Secondary reflector is precision formed from highly reflective pure aluminium.

Available in three different sizes.

## Accessories

No accessories available.

## Finish

Powder coat in black or white colour.

## LED sources

Samsung SMD LED.

CRI: 90 | CCT: 3000K, 4000K.

Other CRI and CCT options, Tuneable White and DimToWarm versions available on request. Emergency versions available upon request.

## Optic

Equipped with acrylic diffuser. Lens in PMMA. Wide beam angle available.

## Driver

Supplied with No-dimable remote driver.

Dimming Options: 0-10V Dim, DALI, Phase, CASAMBI.

## Applications

Provide a visual comfortable energy-efficient with a wide uniform general lighting solution, also ideal for use in under canopy or bathroom locations.

Application areas: offices, corridors, canopies hospital, hotels.

## Related Products



# Galaxis Pro



Galaxis Pro 165 / 200 / 230

Fixed

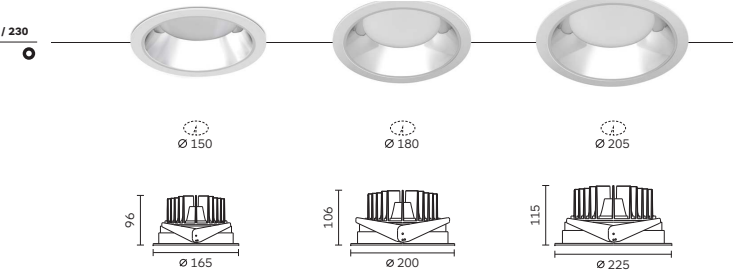

Code ordering example: **R K 1 5 B M 1 1 - 9 0 3 0 7 5 D 0 1 0**

	Product Code	Light Source Code*	>CRI	CCT**	LED Power	Nominal Lumen	Beam Angle (BA°)	Driver Options	Finish
Galaxis Pro 165	<b>RK15</b>	<b>BM11</b> SumSung SMD	<b>90</b>	<b>30</b> 3000K	22W	2574 lm	<b>75</b>	<b>D0</b> No Dim	<b>10</b> Black
Galaxis Pro 200	<b>RK13</b>			<b>40</b> 4000K	33W	3784 lm		<b>DA</b> Dali Dim	<b>11</b> White
Galaxis Pro 230	<b>RK12</b>				45W	4983 lm		<b>DC</b> CASAMBI	
Galaxis Pro 230						5269 lm		<b>D1</b> 0-10V Dim	

## Notes:

\* For complete code ordering information, please see page 377.

\*\* For other CCT options, please contact us.

# Circo & Quadro

Recessed Round & Square 300 | 400 | 630

## Circo



## Quadro



## Body

Round and square mounting trim in polycarbonate with brackets for trim/trimless installation on a ceiling thickness of max. 30mm.

Luminaire body in injection molded polycarbonate with easy removable satin-opal diffuser inclusive of durable silicon gasket. IP66 (dust tight and jetproof).

Easy maintenance. No tools required due to the removable diffuser. Available in three different sizes.

## Accessories

No accessories available.

## Finish

Powder coat in white colour.

## LED sources

Samsung SMD LED.  
CRI: 90 | CCT: 3000K, 4000K.  
Other CRI and CCT options, Tuneable White and DimToWarm versions available on request.

## Optic

Equipped with acrylic satin opal diffuser.

## Driver

Supplied with No-dimable integrated driver.  
Dimming Options: 0-10V Dim, DALI, Phase, CASAMBI.

## Applications

Recessed architectural decorative luminaire designed to provide specification of exceptional glare free and high IP grade quality lighting at prices to fit budgets.  
Application areas: retail, hospitality, offices, schools and community buildings.

## Related Products

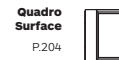

## Circo



### Circo 300 / 400 / 630

Round Trim

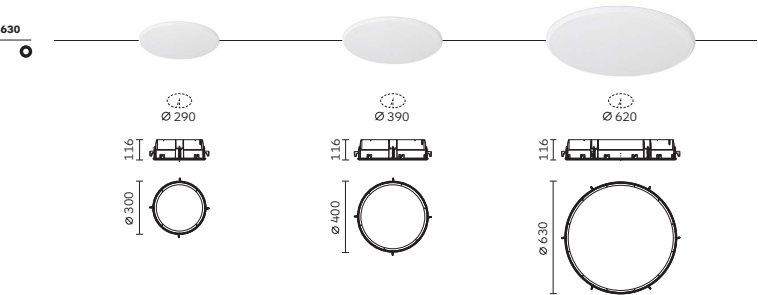

### Circo 300 / 400 / 630

Round Trimless

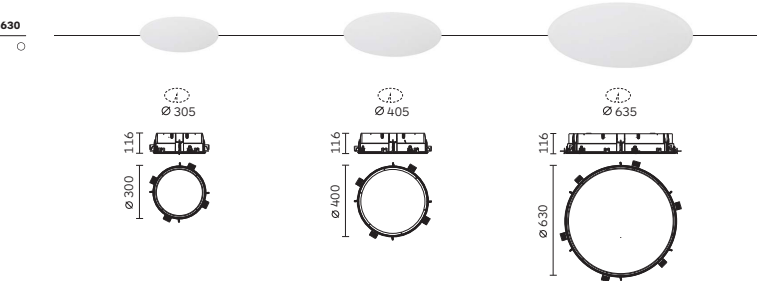

Code ordering example: **RD36BM11-903000D011**

	Product Code	Light Source Code*	>CRI	CCT**	LED Power	Nominal Lumen	Beam Angle (BA°)	Driver Options	Finish
Circo 300 Round	<b>RD36</b> <input checked="" type="radio"/>	<b>BM11</b>	<b>90</b>	<b>30</b> 3000K	30W	2650 lm	EW( <b>00</b> )	<b>D0</b> No Dim	<b>11</b> <input type="checkbox"/> White
	<b>RD59</b> <input type="radio"/>			<b>40</b> 4000K		2850 lm		<b>DA</b> Dali Dim	
Circo 400 Round	<b>RD34</b> <input checked="" type="radio"/>				45W	3800 lm		<b>DP</b> Phase Dim	
	<b>RD57</b> <input type="radio"/>					4000 lm		<b>DC</b> CASAMBI	
Circo 630 Round	<b>RD32</b> <input checked="" type="radio"/>				80W	6800 lm		<b>D1</b> 0-10V Dim	
	<b>RD55</b> <input type="radio"/>					7100 lm			

### Notes:

\* For complete code ordering information, please see page 377.

\*\* For other CCT options, please contact us.

EW = Extra Wide. Ordering code: **00**.

# Quadro



**Quadro 300 / 400 / 630**  
Square Trim

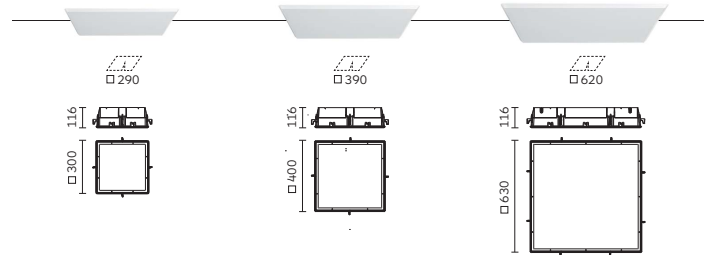

**Quadro 300 / 400 / 630**  
Square Trimless

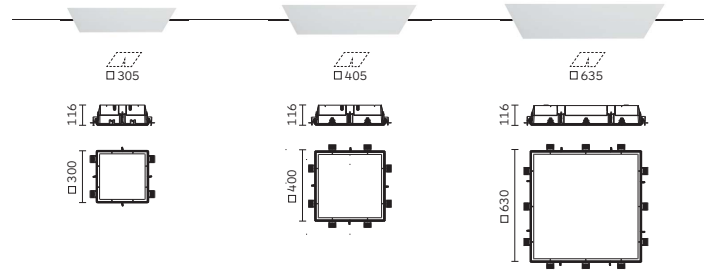

Code ordering example: RD35 BM11 - 90 3000 D011

	Product Code	Light Source Code*	>CRI	CCT**	LED Power	Nominal Lumen	Beam Angle (BA°)	Driver Options	Finish
Quadro 300 Square	<b>RD35</b> <input checked="" type="checkbox"/>	<b>BM11</b>	<b>90</b>	<b>30</b> 3000K	30W	2650 lm	EW(00)	<b>D0</b> No Dim	<b>11</b> <input type="checkbox"/> White
	<b>RD60</b> <input type="checkbox"/>			<b>40</b> 4000K		2850 lm		<b>DA</b> Dali Dim	
Quadro 400 Square	<b>RD33</b> <input checked="" type="checkbox"/>				45W	3800 lm		<b>DP</b> Phase Dim	
	<b>RD58</b> <input type="checkbox"/>					4000 lm		<b>DC</b> CASAMBI	
Quadro 630 Square	<b>RD31</b> <input checked="" type="checkbox"/>				80W	6800 lm		<b>D1</b> 0-10V Dim	
	<b>RD56</b> <input type="checkbox"/>					7100 lm			

**Notes:**  
 \* For complete code ordering information, please see page 377.  
 \*\* For other CCT options, please contact us.  
 EW = Extra Wide. Ordering code: **00**.

# Circo & Quadro Recessed Family configuration options

Code ordering example: RD36 BM11 - 90 3000 D011

## Circo / Quadro 300 Round & Square Fixed

Product Code	Light Source Code	>CRI	CCT	LED Power	Nominal Lumen	Beam Angle (BA°)	Driver Options	Finish
<b>RD36</b> <input checked="" type="checkbox"/>	<b>BM11</b> Samsung SMD	<b>90</b>	<b>30</b> 3000K	30W	2650 lm	EW(00)	<b>D0</b> No Dim	<b>11</b> <input type="checkbox"/> White
<b>RD59</b> <input type="checkbox"/>			<b>40</b> 4000K		2850 lm		<b>DA</b> Dali Dim	
<b>RD35</b> <input checked="" type="checkbox"/>							<b>DP</b> Phase Dim	
<b>RD60</b> <input type="checkbox"/>							<b>DC</b> CASAMBI	
							<b>D1</b> 0-10V Dim	

## Circo / Quadro 400 Round & Square Fixed

Product Code	Light Source Code	>CRI	CCT	LED Power	Nominal Lumen	Beam Angle (BA°)	Driver Options	Finish
<b>RD34</b> <input checked="" type="checkbox"/>	<b>BM11</b> Samsung SMD	<b>90</b>	<b>30</b> 3000K	45W	3800 lm	EW(00)	<b>D0</b> No Dim	<b>11</b> <input type="checkbox"/> White
<b>RD57</b> <input type="checkbox"/>			<b>40</b> 4000K		4000 lm		<b>DA</b> Dali Dim	
<b>RD33</b> <input checked="" type="checkbox"/>							<b>DP</b> Phase Dim	
<b>RD58</b> <input type="checkbox"/>							<b>DC</b> CASAMBI	
							<b>D1</b> 0-10V Dim	

## Circo / Quadro 630 Round & Square Fixed

Product Code	Light Source Code	>CRI	CCT	LED Power	Nominal Lumen	Beam Angle (BA°)	Driver Options	Finish
<b>RD32</b> <input checked="" type="checkbox"/>	<b>BM11</b> Samsung SMD	<b>90</b>	<b>30</b> 3000K	80W	6800 lm	EW(00)	<b>D0</b> No Dim	<b>11</b> <input type="checkbox"/> White
<b>RD55</b> <input type="checkbox"/>			<b>40</b> 4000K		7100 lm		<b>DA</b> Dali Dim	
<b>RD31</b> <input checked="" type="checkbox"/>							<b>DP</b> Phase Dim	
<b>RD56</b> <input type="checkbox"/>							<b>DC</b> CASAMBI	
							<b>D1</b> 0-10V Dim	

**Notes:**  
 For other CCT options, please contact us.



# DomoLED

Recessed Round & Square 95 | 180 | 235



## Body

Round and square mounting trim in cast aluminium with springs for trim installation on a ceiling thickness of max. 25mm or brackets for trimless installation on a ceiling thickness of 12-15mm.

Luminaire body of formed white coated steel. Diffuser made of satin opal acrylic. Front trim/diffuser is fitted by snap-in catch action.

IP44 (protection against dust and spraying water). Available in three sizes.

## Accessories

No accessories available.

## Finish

Powder coat in black, white or grey colour.

## LED sources

Samsung SMD LED.  
CRI: 90 | CCT: 3000K, 4000K.  
Other CRI and CCT options, Tuneable White and DimToWarm versions available on request.

## Optic

Equipped with acrylic satin opal diffuser.

## Driver

Supplied with No-dimable remote driver.  
Dimming Options: 0-10V Dim, DALI, Phase, CASAMBI.

## Applications

Provide a visual comfortable energy-efficient with a wide uniform general lighting solution, also ideal for use in under canopy or bathroom locations.  
Application areas: offices, receptions, hospitals, bathrooms, residential, hotels.

## Related Products

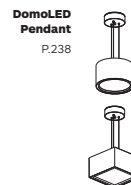
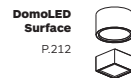
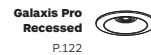

## DomoLED Round



### DomoLED 95 / 180 / 235

Round Trim

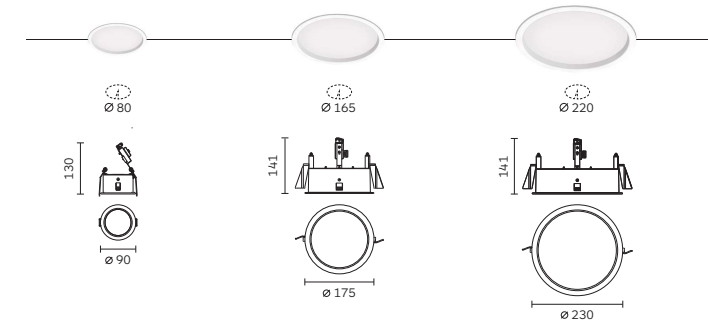

### DomoLED 95 / 180 / 235

Round Trimless

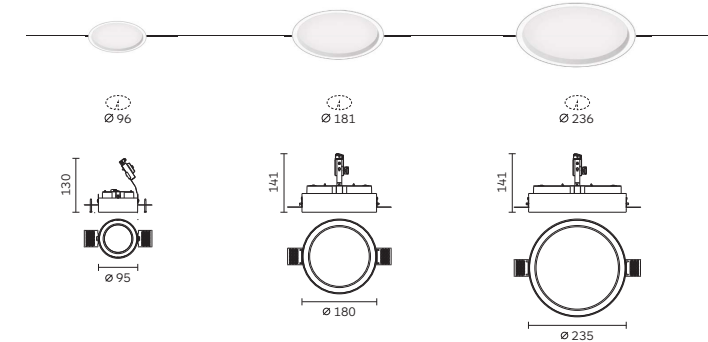

Code ordering example: **RE23BM11-903000D010**

	Product Code	Light Source Code*	>CRI	CCT**	LED Power	Nominal Lumen	Beam Angle (BA°)	Driver Options	Finish
DomoLED 95 Round	<b>RE23</b> <input checked="" type="radio"/>	<b>BM11</b>	<b>90</b>	<b>30</b> 3000K	8W	930 lm	EW( <b>00</b> )	<b>D0</b> No Dim	<b>10</b> <input checked="" type="checkbox"/> Black
	<b>RE24</b> <input type="radio"/>			<b>40</b> 4000K		950 lm		<b>DA</b> Dali Dim	<b>11</b> <input type="checkbox"/> White
DomoLED 180 Round	<b>RE21</b> <input checked="" type="radio"/>				22W	2520 lm		<b>DP</b> Phase Dim	<b>75</b> <input type="checkbox"/> Grey
	<b>RE22</b> <input type="radio"/>					2650 lm		<b>DC</b> CASAMBI	
DomoLED 235 Round	<b>RE19</b> <input checked="" type="radio"/>				35W	3600 lm		<b>D1</b> 0-10V Dim	
	<b>RE20</b> <input type="radio"/>					3760 lm			

### Notes:

\* For complete code ordering information, please see page 377.

\*\* For other CCT options, please contact us.

EW = Extra Wide. Ordering code: **00**.

# DomoLED Square



**DomoLED 95 / 180 / 235**  
Fixed Square Trim

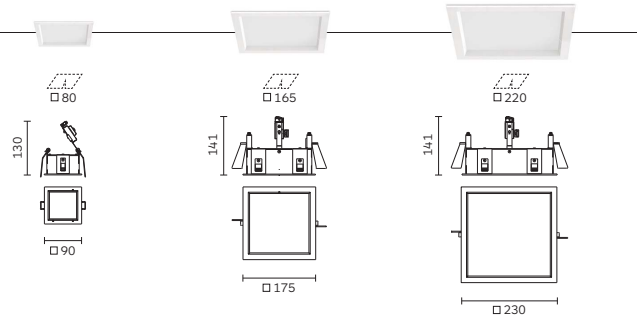

**DomoLED 95 / 180 / 235**  
Square Trimless

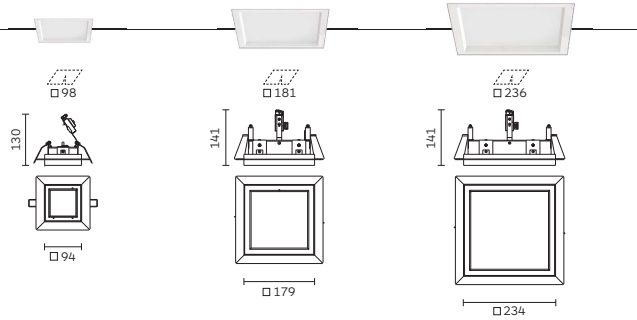

Code ordering example: R D 2 6 B M 1 1 - 9 0 3 0 0 0 0 0 1 0

	Product Code	Light Source Code*	>CRI	CCT**	LED Power	Nominal Lumen	Beam Angle (BA°)	Driver Options	Finish
DomoLED 95 Square	<b>RD26</b> <input type="checkbox"/>	<b>BM11</b>	<b>90</b>	<b>30</b> 3000K	8W	930 lm	EW(00)	<b>D0</b> No Dim	<b>10</b> <input checked="" type="checkbox"/> Black
	<b>RE28</b> <input type="checkbox"/>			<b>40</b> 4000K		950 lm		<b>DA</b> Dali Dim	<b>11</b> <input type="checkbox"/> White
DomoLED 180 Square	<b>RD18</b> <input type="checkbox"/>	<b>BM11</b>			22W	2520 lm		<b>DP</b> Phase Dim	<b>75</b> <input checked="" type="checkbox"/> Grey
	<b>RE27</b> <input type="checkbox"/>					2650 lm		<b>DC</b> CASAMBI	
DomoLED 235 Square	<b>RE25</b> <input checked="" type="checkbox"/>	<b>BM11</b>			35W	3600 lm		<b>D1</b> 0-10V Dim	
	<b>RE26</b> <input type="checkbox"/>					3760 lm			

**Notes:**  
 \* For complete code ordering information, please see page 377.  
 \*\* For other CCT options, please contact us.  
 EW = Extra Wide. Ordering code: 00.

# DomoLED Recessed Family configuration options

Code ordering example: R E 2 3 B M 1 1 - 9 0 3 0 0 0 0 1 0

## DomoLED 95 Round & Square Fixed

Product Code	Light Source Code	>CRI	CCT	LED Power	Nominal Lumen	Beam Angle (BA°)	Driver Options	Finish
<b>RE23</b> <input checked="" type="checkbox"/>	<b>BM11</b> Samsung SMD5630	<b>90</b>	<b>30</b> 3000K	8W	930 lm	EW(00)	<b>D0</b> No Dim	<b>10</b> <input checked="" type="checkbox"/> Black
<b>RE24</b> <input type="checkbox"/>			<b>40</b> 4000K		950 lm		<b>DA</b> Dali Dim	<b>11</b> <input type="checkbox"/> White
<b>RD26</b> <input checked="" type="checkbox"/>							<b>DP</b> Phase Dim	<b>75</b> <input checked="" type="checkbox"/> Grey
<b>RE28</b> <input type="checkbox"/>							<b>DC</b> CASAMBI	
							<b>D1</b> 0-10V Dim	

## DomoLED 180 Round & Square Fixed

Product Code	Light Source Code	>CRI	CCT	LED Power	Nominal Lumen	Beam Angle (BA°)	Driver Options	Finish
<b>RE21</b> <input checked="" type="checkbox"/>	<b>BM11</b> Samsung SMD5630	<b>90</b>	<b>30</b> 3000K	22W	2520 lm	EW(00)	<b>D0</b> No Dim	<b>10</b> <input checked="" type="checkbox"/> Black
<b>RE22</b> <input type="checkbox"/>			<b>40</b> 4000K		2650 lm		<b>DA</b> Dali Dim	<b>11</b> <input type="checkbox"/> White
<b>RD18</b> <input checked="" type="checkbox"/>							<b>DP</b> Phase Dim	<b>75</b> <input checked="" type="checkbox"/> Grey
<b>RE27</b> <input type="checkbox"/>							<b>DC</b> CASAMBI	
							<b>D1</b> 0-10V Dim	

## DomoLED 235 Round & Square Fixed

Product Code	Light Source Code	>CRI	CCT	LED Power	Nominal Lumen	Beam Angle (BA°)	Driver Options	Finish
<b>RE19</b> <input checked="" type="checkbox"/>	<b>BM11</b> Samsung SMD5630	<b>90</b>	<b>30</b> 3000K	35W	3600 lm	EW(00)	<b>D0</b> No Dim	<b>10</b> <input checked="" type="checkbox"/> Black
<b>RE20</b> <input type="checkbox"/>			<b>40</b> 4000K		3760 lm		<b>DA</b> Dali Dim	<b>11</b> <input type="checkbox"/> White
<b>RE25</b> <input checked="" type="checkbox"/>							<b>DP</b> Phase Dim	<b>75</b> <input checked="" type="checkbox"/> Grey
<b>RE26</b> <input type="checkbox"/>							<b>DC</b> CASAMBI	
							<b>D1</b> 0-10V Dim	

**Notes:**  
 For other CCT options, please contact us.

# Ola Compasso

Track 55 | 100 | 130



## Body

Track mounted spotlight with light head and arm in cast aluminium. Integrated driver front cover in thermoplastic.

Available with three circuit universal track adapter or Dali track adapter. Light head designed for passive cooling. Available in three different sizes and two different design.

Versatile aiming angle tiltable vertically 0°-90° in two direction and rotatable horizontally 360°.

## Accessories

No accessories available.

## Finish

Powder coat in black and white colour.

## LED sources

Citizen CLU series. SORAA SLC Optical Light Engine. Cree single power led (130).  
CRI: 90, 95 | CCT: 3000K, 4000K, TuneableWhite.  
Other CRI and CCT options available on request.

## Optic

Lenses.  
Narrow, medium, white and wallwasher beam angle available.

## Driver

Track adaptor inclusive of integrated no-dimable driver.  
Dimming Options: DALI, CASAMBI.

## Applications

A chic and alluring light fixture, designed by formalighting's passionate engineers. The circular shaped classic design easily integrates into various architectural environments. Application areas: retail, museums, residential, restaurants.

### Related Products



# Ola Compasso



Ola Compasso 55 / 100 / 130

Track

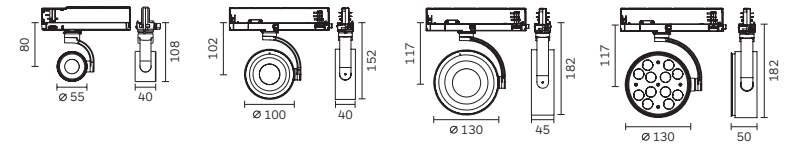

Code ordering example: 6 5 3 6 B C 2 2 - 9 0 3 0 1 8 D 0 1 0

	Product Code	Light Source Code*	>CRI	CCT**	LED Power	Nominal Lumen	Beam Angle (BA°)	Driver Options	Finish
Ola Compasso 55 Track	<b>6536</b>	<b>BC22</b> Citizen COB	<b>90</b>	<b>30</b> 3000K	8W	1062 lm	<b>18 / 24 / 36</b>	<b>D0</b> No Dim	<b>10</b> ■ Black
					40 4000K	1078 lm		<b>DA</b> Dali Dim	<b>11</b> □ White
					8.1W	460 lm	<b>10</b>	<b>DC</b> CASAMBI	
					480 lm				
					12.2W	720 lm	<b>15 / 24 / 36</b>		
						755 lm			
Ola Compasso 100 Track	<b>6533</b>	<b>BC33</b> Citizen COB	<b>90</b>		17W	1934 lm	<b>15 / 24 / 38</b>		
						2041 lm			
					16.1W	1000 lm	<b>09 / 25 / 36</b>		
					1050 lm				
Ola Compasso 130 Track	<b>6534</b>	<b>BC33</b> Citizen COB	<b>90</b>		24W	2595 lm	<b>12 / 22 / 32</b>		
						2697 lm			
						2544 lm	<b>17 / 25 / 46</b>		
		<b>BR11</b> Cree 3535			2724 lm				

### Notes:

\* For complete code ordering information, please see page 377.

\*\* For other CCT options, please contact us.

# Zero Compasso

Track 40 | 66 | 100 | 130



## Body

Track mounted spotlight, inclusive of integrated driver, with light head in cast aluminium. Inclusive of reflector in metalized PC.

Available with 3 circuit universal track adapter or Dali track adapter. Designed for passive cooling. Available in three different sizes.

Versatile aiming angle tiltable vertically 0°-90° and rotatable horizontally 360°.

## Accessories

Coloured filters, linear spread, honeycomb louvre, visor, snoot.  
Snap System™ accessories available for SORAA SLC series with narrow beam angle.

## Finish

Powder coat in black and white colour.

## LED sources

Citizen CLU Series. Xicato Artist, Beauty and Designer Series. SORAA SLC Optical Light Engine.  
CRI: 90, 95, 98 | CCT: 2700K, 3000K, 4000K.  
Other CRI and CCT options, Tuneable White and DimToWarm versions available on request.

## Optic

Reflector.  
Narrow, medium and wide beam angle available.

## Driver

Supplied with integrated no-dimable driver.  
Dimming Options: 0-10V Dim, DALI, Phase, CASAMBI.

## Applications

A modern design consisting for the purpose to meet the highest requirements of the latest advanced lighting technology.  
Application areas: retail, museums, hospitality, residential, offices, lobbies.

### Related Products

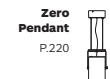
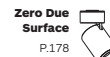
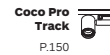
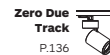

# Zero Compasso



Zero Compasso 40 / 66 / 100 / 130

Track

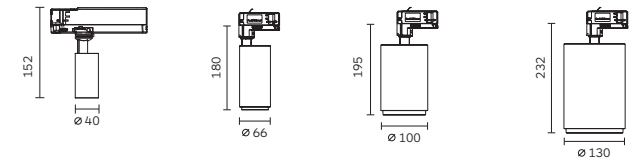

Code ordering example: **6 5 2 6 B C 3 2 - 9 0 3 0 1 5 D 0 1 0**

	Product Code	Light Source Code*	>CRI	CCT**	LED Power	Nominal Lumen	Beam Angle (BA°)	Driver Options	Finish
Zero Compasso 40 Track	<b>6537</b>	<b>BR12</b>	<b>90</b>	<b>30</b> 3000K	4W	440 lm	<b>04</b>	<b>D0</b> No Dim <b>DA</b> Dali Dim	<b>10</b> ■ Black <b>11</b> □ White
Zero Compasso 66 Track	<b>6526</b>	<b>BC32</b>		<b>30</b> 3000K <b>40</b> 4000K	12W	1357 lm 1414 lm	<b>05</b> <b>15 / 23 / 45</b>	<b>DC</b> CASAMBI	
Zero Compasso 100 Track	<b>6490</b>	<b>BC21</b>			25W	3018 lm 3064 lm	<b>20 / 30 / 38</b>	<b>D0</b> No Dim <b>DA</b> Dali Dim	
Zero Compasso 130 Track	<b>6489</b>	<b>BC21</b>			37W	4147 lm 4210 lm	<b>14 / 24 / 38</b>	<b>DP</b> Phase Dim <b>DC</b> CASAMBI <b>D1</b> 0-10V Dim	

### Notes:

\* For complete code ordering information, please see page 377.

\*\* For other CCT options, please contact us.

For related accessories, please see page 139.

# Zero Due

Track 66 | 100 | 130



## Body

Track mounted spotlight with light head and driver canopy in cast aluminium. Inclusive of reflector in metalized PC.

Available with 3 circuit universal track adapter or Dali track adapter. Designed for passive cooling. Available in three different sizes.

Versatile aiming angle tiltable vertically 0°-90° and rotatable horizontally 360°.

## LED sources

Citizen CLU Series. Xicato Artist, Beauty and Designer Series. SORAA SLC Optical Light Engine. CRI: 90, 95, 98 | CCT: 2700K, 3000K, 4000K. Other CRI and CCT options, Tuneable White and DimToWarm versions available on request.

## Optic

Reflector. Narrow, medium and wide beam angle available.

## Accessories

Coloured filters, linear spread, honeycomb louvre, visor, snoot. Snap System™ accessories available for SORAA SLC series with narrow beam angle.

## Finish

Powder coat in black and white colour.

## Driver

Driver canopy inclusive of no-dimable driver. Dimming Options: 0-10V Dim, DALI, Phase, CASAMBI. The shape of the box may change according with the chosen dimming options.

## Applications

A modern design consisting for the purpose to meet the highest requirements of the latest advanced lighting technology. Application areas: retail, museums, hospitality, residential, offices, lobbies.

### Related Products

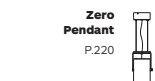
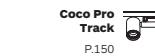

# Zero Due



Zero Due 66 / 100 / 130

Track

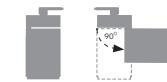
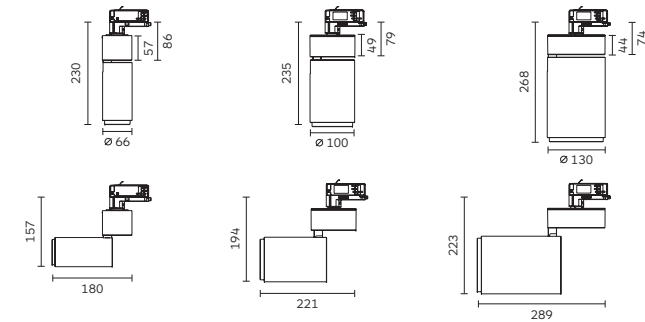

Code ordering example: **6 4 5 5 B C 3 2 - 9 0 3 0 1 5 D 0 1 0**

	Product Code	Light Source Code*	>CRI	CCT**	LED Power	Nominal Lumen	Beam Angle (BA°)	Driver Options	Finish
Zero Due 66 Track	<b>6455</b>	<b>BC32</b>	<b>90</b>	<b>30</b> 3000K	12W	1357 lm	<b>15 / 23 / 45</b>	<b>D0</b> No Dim	<b>10</b> ■ Black
				<b>40</b> 4000K		1414 lm		<b>DA</b> Dali Dim	<b>11</b> □ White
Zero Due 100 Track	<b>6447</b>	<b>BC33</b>			33W	3114 lm	<b>12 / 27 / 55</b>	<b>D0</b> No Dim	
					3245 lm	<b>DA</b> Dali Dim			
Zero Due 130 Track	<b>6438</b>	<b>BC34</b>			45W	3978 lm	<b>10 / 18 / 42</b>	<b>DP</b> Phase Dim	
					4144 lm	<b>DC</b> CASAMBI		<b>D1</b> 0-10V Dim	

### Notes:

\* For complete code ordering information, please see page 377.

\*\* For other CCT options, please contact us.

For related accessories, please see page 139.

## Zero Compasso & Zero Due Family configuration options

Code ordering example: 6 4 5 5 B C 3 2 - 9 0 3 0 1 5 D 0 1 0

### Zero Compasso 40

Track

Product Code	Light Source Code	>CRI	CCT	LED Power	Nominal Lumen	Beam Angle (BA°)	Driver Options	Finish
6537 Zero Compasso	BR12 Cree 3535	90	30 3000K	4W	440 lm	04	D0 No Dim DA Dali Dim DC CASAMBI	10 ■ Black 11 □ White

### Zero Compasso & Zero Due 66

Track

Product Code	Light Source Code	>CRI	CCT	LED Power	Nominal Lumen	Beam Angle (BA°)	Driver Options	Finish
6455 Zero Due	BC32 Citizen COB	90	30 3000K	12W	1357 lm	15 / 23 / 45	D0 No Dim	10 ■ Black
6526 Zero Compasso	BS12 Soraa SLC-16	95	40 4000K	10W	500 lm	10 / 25 / 36	DA Dali Dim	11 □ White
	BX25 Xicato Artist XTM	98	27 2700K	20W	1700 lm	30 / 42 / 55		
	BX32 Xicato Beauty XTM	95			2000 lm	28 / 35 / 45		
	BX42 Xicato Designer XTM	90		17.1W				
	BR12 Cree 3535	90	30 3000K	4W	440 lm	05		

### Zero Compasso & Zero Due 100

Track

Product Code	Light Source Code	>CRI	CCT	LED Power	Nominal Lumen	Beam Angle (BA°)	Driver Options	Finish
6447 Zero Due	BC33 Citizen COB	90	30 3000K	33W	3114 lm	12 / 27 / 55	D0 No Dim	10 ■ Black
6490 Zero Compasso	BC21		40 4000K	25 W	3018 lm	20 / 30 / 38	DP Phase Dim DC CASAMBI	11 □ White
6447 Zero Due	BS12 Soraa SLC-30	95		20W	1200 lm	09 / 25 / 36		
6490 Zero Compasso					1300 lm			
	BX26 Xicato Artist XTM	98	27 2700K	30.5W	2140 lm	20 / 40 / 60		
	BX43 Xicato Designer XTM	90		25.7W				

### Zero Compasso & Zero Due 130

Track

Product Code	Light Source Code	>CRI	CCT	LED Power	Nominal Lumen	Beam Angle (BA°)	Driver Options	Finish
6438 Zero Due	BC34 Citizen COB	90	30 3000K	45W	3978 lm	10 / 18 / 42	D0 No Dim	10 ■ Black
6489 Zero Compasso	BC21		40 4000K	37W	4144 lm	14 / 24 / 38	DA Dali Dim DP Phase Dim DC CASAMBI	11 □ White
6438 Zero Due	BX18 Xicato Standard XTM	83	27 2700K	30.5W	3850 lm	20 / 40 / 60	D1 0-10V Dim	
6489 Zero Compasso	BX44 Xicato Designer XTM	90		41.8W	4500 lm			

#### Notes:

For other CCT options, please contact us.

## Optical Accessories

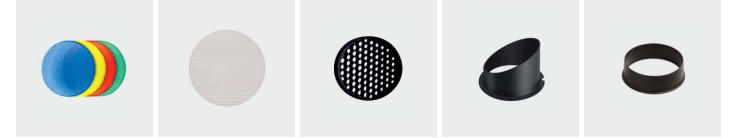

Product / Optical Accessories	Coloured Filters Colours 25, 42, 55, 85	Linear Spread Colour 41	Honeycomb Louvre Colour 10	Visor Colours 10, 17	Snoot Colours 10, 17
Zero Compasso / Zero Due 66 Track	2A48*	2A51	2A54	2A60	2A65
Zero Compasso / Zero Due 100 Track	2A47*	2A50	2A53	2A64	2A59
Zero Compasso / Zero Due 130 Track	2A46*	2A49	2A52	2A63	2A58

\* With holder

# Zero Projector

Iris, Gobo & Framing Track



## Body

Projector with light head and driver box in cast aluminium. Available with 3 circuit universal track adapter or Dali track adapter. Versatile aiming angle tiltable vertically 0°-90° and rotatable horizontally 350°.

**Framing Projector:** polygonal projection. Equipped with 4 shutters to shape and project the light precisely at the desired point. Manual focus adjustment to obtain well defined sharp edges or a shaded effect.

**Iris Projector:** equipped with lenses, snoot and single shutter zoom. Manual focus adjustment to obtain the desired light beam and to well define smaller objects.

**Gobo Projector:** the incorporated lens with snoot allow to project the inserted image/logo. Manual focus adjustment to obtain a well defined image onto a desired surface.

## Accessories

Framing and shape lens are included in the specific projector. Contact us for custom made logo projection lens.

## Finish

Powder coat in black and white colour.

## LED sources

Citizen CLU Series.

CRI: 90 | CCT: 3000K, 4000K.

Other CRI and CCT options, Tuneable White, DimToWarm RGB/W versions available on request.

## Optic

Lenses.

Narrow and medium zoom optics included. single shutter zoom included.

## Driver

Inclusive of no-dimable driver.

Dimming Options: 0-10V Dim, DALI, Phase, CASAMBI.

## Applications

Particularly designed for accent lighting of objects in window display exhibition areas and for the projection of advertising images.

Application areas: museums, hospitality, retail, interior design.

### Related Products

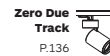

# Iris Projector



## Iris Projector 66

Track

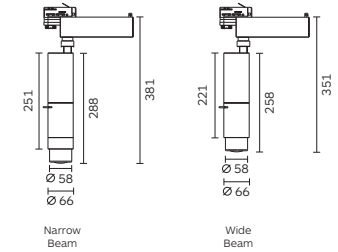

Code ordering example: **6 4 8 4 B C 3 1 - 9 0 3 0 1 5 D 0 1 0**

	Product Code	Light Source Code*	>CRI	CCT**	LED Power	Nominal Lumen	Beam Angle (BA°)	Driver Options	Finish
Iris Projector 66 Track	<b>6484</b>	<b>BC31</b> Citizen COB	<b>90</b>	<b>30</b> 3000K	14W	1247 lm	<b>15 / 25</b>	<b>D0</b> No Dim	<b>10</b> ■ Black
			<b>40</b>	4000K		1395 lm		<b>DA</b> Dali Dim	<b>11</b> □ White
								<b>DP</b> Phase Dim	
								<b>DC</b> CASAMBI	
								<b>D1</b> 0-10V Dim	

### Notes:

\* For complete code ordering information, please see page 377.

\*\* For other CCT options, please contact us.

## Gobo Projector



### Gobo Projector 66

Track

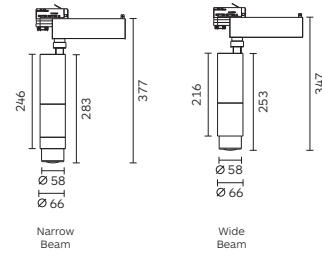
Code ordering example: 6485 BC31 - 90 30 15 D0 10

	Product Code	Light Source Code*	>CRI	CCT**	LED Power	Nominal Lumen	Beam Angle (BA°)	Driver Options	Finish	
Gobo Projector 66 Track	6485	BC31 Citizen COB	90	30	3000K	14W	1247 lm	15 / 25	D0 No Dim	10 ■ Black
				40	4000K		1395 lm		DA Dali Dim	11 □ White
									DP Phase Dim	
									DC CASAMBI	
							D1 0-10V Dim			

#### Notes:

- \* For complete code ordering information, please see page 377.
- \*\* For other CCT options, please contact us.

## Framing Projector



### Framing Projector 100

Track

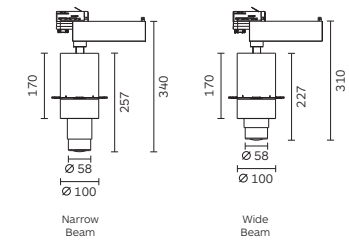
Code ordering example: 6483 BC31 - 90 30 15 D0 10

	Product Code	Light Source Code*	>CRI	CCT**	LED Power	Nominal Lumen	Beam Angle (BA°)	Driver Options	Finish	
Framing Projector 100 Track	6483	BC31 Citizen COB	90	30	3000K	14W	1247 lm	15 / 25	D0 No Dim	10 ■ Black
				40	4000K		1395 lm		DA Dali Dim	11 □ White
									DP Phase Dim	
									DC CASAMBI	
							D1 0-10V Dim			

#### Notes:

- \* For complete code ordering information, please see page 377.
- \*\* For other CCT options, please contact us.



# Polaris

Designed by **Franco Mireni** (Registered)

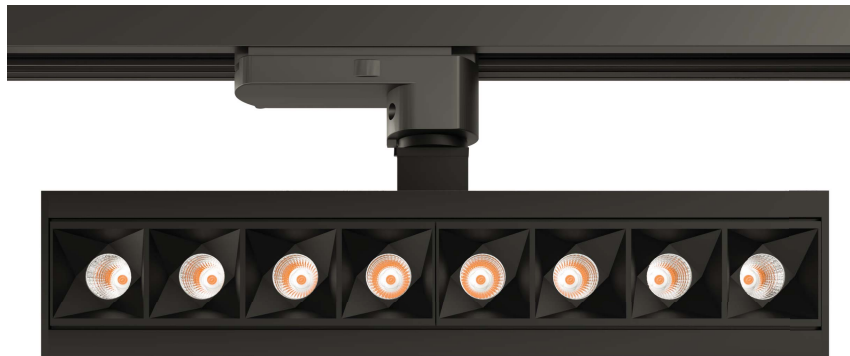

## Body

Track mounted spotlight with light body in extruded aluminium inclusive of integrated diamond faceted no-dazzle louvre in thermoplastic.

Available with 3 circuit universal track adapter or Dali track adapter. Equipped with metallized polycarbonate reflector. Available in configurations of 4, 8, 12 light heads.

Versatile aiming angle tiltable vertically 0°-90° in two directions and rotatable horizontally 360°.

## LED sources

Citizen CLU Series, Osram Oslon Square high power led  
CRI: 90 | CCT: 3000K, 4000K, TuneableWhite (30)  
Other CRI and CCT options available on request.

## Optic

Reflector: Medium and wide beam angle available.  
UGR<13 for a better visual comfort.

## Accessories

No accessories available.

## Finish

Light body powder coat in black or white finish. Integrated louvre available in black or white finish.

## Driver

Inclusive of integrated no-dimable driver.  
Dimming Options: 0-10V Dim, DALI, Phase, CASAMBI.

## Applications

An innovative solution for high brilliance and performance. The light source is barely visible, as the miniature light heads create a high contrast and circular light emission.  
Application areas: residential, hotels, restaurants, retail, corridors.

### Related Products



## Polaris 30



**Polaris 30**  
Track 4 / 8 / 12

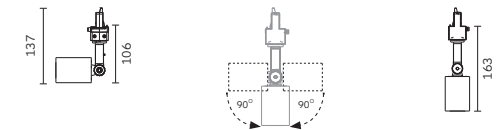
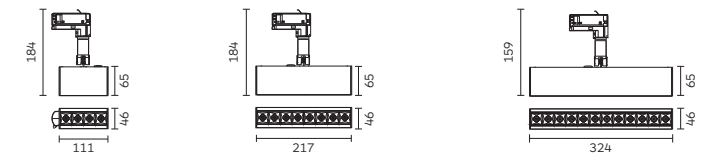

Code ordering example: **6 4 8 0 B O 1 1 - 9 0 3 0 3 4 D 0 1 0**

	Product Code	Light Source Code*	>CRI	CCT**	LED Power	Nominal Lumen	Beam Angle (BA°)	Driver Options	Finish	
Polaris 30 Track 4	<b>6480</b>	<b>BO11</b> Osram	3030	<b>90</b>	<b>30</b> 3000K	4x2W	760 lm	<b>34 / 50</b>	<b>D0</b> No Dim	<b>10</b> ■ Black
				<b>40</b> 4000K		960 lm		<b>DA</b> Dali Dim	<b>11</b> □ White	
Polaris 30 Track 8	<b>6481</b>				8x2W	1520 lm		<b>DC</b> CASAMBI	<b>17</b> ▣ B/W	
						1920 lm				
Polaris 30 Track 12	<b>6482</b>				12x2W	2280 lm				
						2880 lm				

### Notes:

\* For complete code ordering information, please see page 377.

\*\* For other CCT options, please contact us.

**17:** white light body with black integrated louvre. For black body with white integrated louvre consult us.

# Palla Compasso

Designed by **Franco Mireni** (Registered)



## Body

Track mounted spotlight with light-head and mounting arm in cast aluminium.

Available with three circuit universal track adapter or Dali track adapter. Include transparent safety cover to protect the led source accessible through a twist and lock front bezel. Available in three different sizes.

Versatile aiming angle tiltable vertically 0°-90° in two directions and rotatable horizontally 360°.

## Accessories

Honeycomb louvre, anti-glare hood, snoot and visor. Snap System™ accessories available for SORAA SLC series with narrow beam angle.

## Finish

Powder coat in black and white colour.

## LED sources

Citizen CLU Series. Xicato Artist, Beauty and Designer Series. SORAA SLC Optical Light Engine. CRI: 90, 95, 98 | CCT: 2700K, 3000K, 4000K. Other CRI and CCT options, Tuneable White and DimToWarm versions available on request.

## Optic

Lens. Narrow, medium and wide beam angle available.

## Driver

Track adaptor inclusive of integrated no-dimable driver. Dimming Options: 0-10V Dim, DALI, Phase, CASAMBI.

## Applications

Semi-spherical design for the purpose to meet the highest requirements of the latest advance in lighting technology. Great for wallwashing to illuminate vertical surface and upper area of wall.

Application areas: retail, museums, hospitality, offices.

## Related Products

**Palla In & Out Recessed**  
P.28



**Palla Surface**  
P.182



**Palla Pendant**  
P.224



# Palla Compasso



## Palla Compasso 70 / 100 / 130

Track

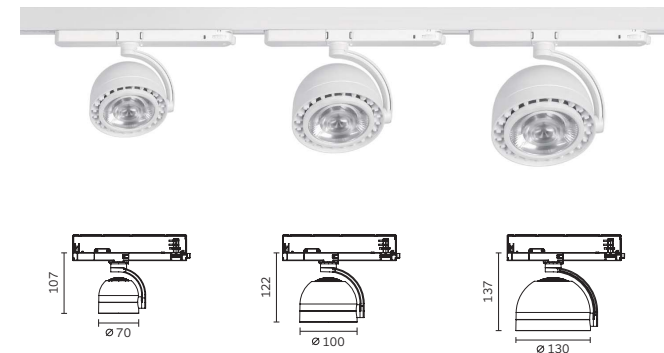

Code ordering example: **6 3 3 1 B C 2 2 - 9 0 3 0 1 6 D 0 1 0**

	Product Code	Light Source Code*	>CRI	CCT**	LED Power	Nominal Lumen	Beam Angle (BA°)	Driver Options	Finish
Palla Compasso 70 Track	<b>6331</b>	<b>BC22</b>	<b>90</b>	<b>30</b> 3000K	12W	1500 lm	<b>16 / 25 / 36</b>	<b>D0</b> No Dim	<b>10</b> ■ Black
				<b>40</b> 4000K		1550 lm		<b>DA</b> Dali Dim	<b>11</b> □ White
Palla Compasso 100 Track	<b>6332</b>	<b>BC33</b>			21W	2200 lm	<b>15 / 24 / 38</b>	<b>DC</b> CASAMBI	
						2300 lm			
Palla Compasso 130 Track	<b>6333</b>	<b>BC33</b>			33W	3220 lm	<b>12 / 22 / 32</b>		
						3300 lm			

## Notes:

\* For complete code ordering information, please see page 377.

\*\* For other CCT options, please contact us.

For related accessories, please see page 149.

## Palla Compasso Family configuration options

Code ordering example: 6 3 3 1 B C 2 2 - 9 0 3 0 1 6 D 0 1 0

### Palla Compasso 70

Track

Product Code	Light Source Code	>CRI	CCT	LED Power	Nominal Lumen	Beam Angle (BA°)	Driver Options	Finish
<b>6331</b>	<b>BC22</b> Citizen COB	<b>90</b>	<b>30</b> 3000K	12W	1500 lm	<b>16 / 25 / 36</b>	<b>D0</b> No Dim	<b>10</b> ■ Black
			<b>40</b> 4000K		1550 lm		<b>DA</b> Dali Dim	
	<b>BS12</b> Soraa SLC-16	<b>95</b>		10W	500 lm	<b>10 / 25 / 36</b>	<b>DC</b> CASAMBI	
					525 lm			

### Palla Compasso 100

Track

Product Code	Light Source Code	>CRI	CCT	LED Power	Nominal Lumen	Beam Angle (BA°)	Driver Options	Finish
<b>6332</b>	<b>BC33</b> Citizen COB	<b>90</b>	<b>30</b> 3000K	21W	2200 lm	<b>15 / 24 / 38</b>	<b>D0</b> No Dim	<b>10</b> ■ Black
			<b>40</b> 4000K		2300 lm		<b>DA</b> Dali Dim	
	<b>BS12</b> Soraa SLC-16	<b>95</b>		14W	800 lm	<b>10 / 25 / 36</b>	<b>DC</b> CASAMBI	
					850 lm			
	<b>BX25</b> Xicato Artist XTM	<b>98</b>	<b>27</b> 2700K	13W	1400 lm	<b>16 / 28 / 38</b>		
	<b>BX31</b> Beauty XTM	<b>95</b>		9.5W	931 lm	<b>28 / 35 / 45</b>		
	<b>BX41</b> Designer XTM	<b>90</b>		11.4W	1300 lm			

### Palla Compasso 130

Track

Product Code	Light Source Code	>CRI	CCT	LED Power	Nominal Lumen	Beam Angle (BA°)	Driver Options	Finish
<b>6333</b>	<b>BC33</b> Citizen COB	<b>90</b>	<b>30</b> 3000K	33W	3220 lm	<b>12 / 22 / 32</b>	<b>D0</b> No Dim	<b>10</b> ■ Black
			<b>40</b> 4000K		3300 lm		<b>DA</b> Dali Dim	
	<b>BS22</b> Soraa SLC-30	<b>95</b>		20W	1200 lm	<b>09 / 25 / 36</b>	<b>DC</b> CASAMBI	
					1300 lm			
	<b>BX25</b> Xicato Artist XTM	<b>98</b>	<b>27</b> 2700K	20W	2000 lm	<b>25 / 36 / 45</b>		
	<b>BX32</b> Beauty XTM	<b>95</b>						
	<b>BX43</b> Designer XTM	<b>90</b>		25.7W	3000 lm			

#### Notes:

For other CCT options, please contact us.

## Optical Accessories



Product / Optical Accessories	Honeycomb Louvre Colour 10	Visor Colours 10, 17	Snoot Colours 10, 17	Anti-glare Tube Colours 10, 17
Palla Compasso 70 Track	<b>2B95</b>	<b>2B98</b>	<b>2B96</b>	<b>2B97</b>
Palla Compasso 100 Track	<b>2B99</b>	<b>2C03</b>	<b>2C01</b>	<b>2C02</b>
Palla Compasso 130 Track	<b>2C04</b>	<b>2C07</b>	<b>2C05</b>	<b>2C06</b>

For SORAA specific accessories, please contact us and we will provide the detailed information.

# Coco Pro

Track 66 | 100



## Body

Track mounted spotlight with light head and driver box in cast aluminium. Inclusive of reflector in metalized PC.

Available with 3 circuit universal track adapter or Dali track adapter. Available in 2 different sizes and 2 design, horizontal and vertical.

Versatile aiming angle tiltable vertically 0°-90° and rotatable horizontally 350°.

## Accessories

Coloured filters, linear spread, honeycomb louvre, visor, snoot.

Snap System™ accessories available for SORAA SLC series with narrow beam angle.

## Finish

Powder coat in black and white colour.

## LED sources

Citizen CLU Series.

CRI: 90 | CCT: 3000K, 4000K.

Other CRI and CCT options, Tuneable White and DimToWarm versions available on request.

## Optic

Reflector.

Narrow, medium and wide beam angle available.

## Driver

Supplied with no-dimable driver.

Dimming Options: 0-10V Dim, DALI, Phase, CASAMBI.

## Applications

New generation track lighting concept while the cylinders shape stands out for simplicity and makes it a classic design. Application areas: retail, residential, restaurants, hotels, museums, window display, showrooms.

### Related Products

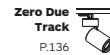

# Coco Pro Horizontal



**Coco Pro 66 / 100**

Horizontal Track

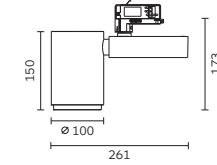
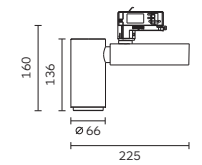

Code ordering example: **6 4 5 0 B C 3 2 - 9 0 3 0 1 5 D 0 1 0**

	Product Code	Light Source Code*	>CRI	CCT**	LED Power	Nominal Lumen	Beam Angle (BA°)	Driver Options	Finish
Coco Pro 66	<b>6450</b>	<b>BC32</b>	<b>90</b>	<b>30</b> 3000K	12W	1357 lm	<b>15 / 23 / 45</b>	<b>D0</b> No Dim	<b>10</b> ■ Black
Horizontal Track				<b>40</b> 4000K		1414 lm		<b>DA</b> Dali Dim	<b>11</b> □ White
Coco Pro 100	<b>6445</b>	<b>BC33</b>			33W	3229 lm	<b>12 / 27 / 55</b>	<b>DP</b> Phase Dim	
Horizontal Track						3365 lm		<b>DC</b> CASAMBI	
								<b>D1</b> 0-10V Dim	

### Notes:

\* For complete code ordering information, please see page 377.

\*\* For other CCT options, please contact us.

For related accessories, please see page 153.

## Coco Pro Vertical



**Coco Pro 66 / 100**  
Vertical Track

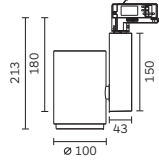
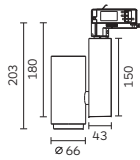

Code ordering example: 6 4 7 9 B C 3 2 - 9 0 3 0 1 5 D 0 1 0

	Product Code	Light Source Code*	>CRI	CCT**	LED Power	Nominal Lumen	Beam Angle (BA°)	Driver Options	Finish
Coco Pro 66 Vertical Track	<b>6479</b>	<b>BC32</b>	<b>90</b>	<b>30</b> 3000K	12W	1357 lm	<b>15 / 23 / 45</b>	<b>D0</b> No Dim	<b>10</b> ■ Black
				<b>40</b> 4000K		1414 lm		<b>DA</b> Dali Dim	<b>11</b> □ White
Coco Pro 100 Vertical Track	<b>6478</b>	<b>BC33</b>			33W	3229 lm	<b>12 / 27 / 55</b>	<b>DP</b> Phase Dim	
						3365 lm		<b>DC</b> CASAMBI	
								<b>D1</b> 0-10V Dim	

### Notes:

- \* For complete code ordering information, please see page 377.
  - \*\* For other CCT options, please contact us.
- For related accessories, please see page 153.

## Coco Pro Family configuration options

Code ordering example: 6 4 5 0 B C 3 2 - 9 0 3 0 1 5 D 0 1 0

### Coco Pro 66 Track

Product Code	Light Source Code	>CRI	CCT	LED Power	Nominal Lumen	Beam Angle (BA°)	Driver Options	Finish
<b>6450</b> Horizontal	<b>BC32</b> Citizen COB	<b>90</b>	<b>30</b> 3000K	12W	1357 lm	<b>15 / 23 / 45</b>	<b>D0</b> No Dim	<b>10</b> ■ Black
<b>6479</b> Vertical			<b>40</b> 4000K		1414 lm		<b>DA</b> Dali Dim	<b>11</b> □ White
	<b>BS12</b> Soraa SLC-16	<b>95</b>		10W	500 lm	<b>10 / 25 / 36</b>	<b>DP</b> Phase Dim	
					525 lm		<b>DC</b> CASAMBI	
	<b>BX25</b> Xicato Artist XTM	<b>98</b>	<b>27</b> 2700K	20W	1700 lm	<b>30 / 42 / 55</b>	<b>D1</b> 1-10V Dim	
	<b>BX32</b> Beauty XTM	<b>95</b>			2000 lm	<b>28 / 35 / 45</b>		
	<b>BX42</b> Designer XTM	<b>90</b>			17.1W			

### Coco Pro 100 Track

Product Code	Light Source Code	>CRI	CCT	LED Power	Nominal Lumen	Beam Angle (BA°)	Driver Options	Finish
<b>6445</b> Horizontal	<b>BC33</b> Citizen COB	<b>90</b>	<b>30</b> 3000K	33W	3229 lm	<b>12 / 27 / 55</b>	<b>D0</b> No Dim	<b>10</b> ■ Black
<b>6478</b> Vertical			<b>40</b> 4000K		3365 lm		<b>DA</b> Dali Dim	<b>11</b> □ White
	<b>BS11</b> Soraa SLC-30	<b>95</b>		20W	1200 lm	<b>09 / 25 / 36</b>	<b>DP</b> Phase Dim	
					1300 lm		<b>DC</b> CASAMBI	
	<b>BX26</b> Xicato Artist XTM	<b>98</b>	<b>27</b> 2700K	30.5W	2140 lm	<b>20 / 40 / 60</b>	<b>D1</b> 0-10V Dim	
	<b>BX43</b> Designer XTM	<b>90</b>			25.7W			

## Optical Accessories

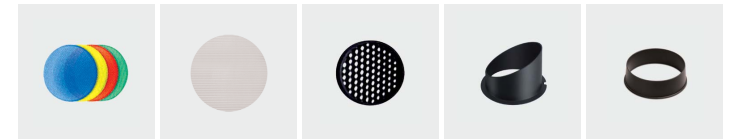

Product / Optical Accessories	Coloured Filters Colours 25, 42, 55, 85	Linear Spread Colour 41	Honeycomb Louvre Colour 10	Visor Colours 10, 17	Snoot Colours 10, 17
Coco Pro 66 Track	<b>2A48*</b>	<b>2A51</b>	<b>2A54</b>	<b>2A60</b>	<b>2A65</b>
Coco Pro 100 Track	<b>2A47*</b>	<b>2A50</b>	<b>2A53</b>	<b>2A64</b>	<b>2A59</b>

\* With holder

### Notes:

For other CCT options, please contact us.

# Arena Due

Designed by **Franco Mirezzi** (Registered)



## Body

Track mounted spotlight with luminaire body and driver box in cast aluminium.

Available with 3 circuit universal track adapter or Dali track adapter. Luminaire body designed with integrated heat-sink for a passive heat dissipation.

Versatile aiming angle tiltable vertically 0°-90° and rotatable horizontally 350°. Possibility to lock the fixture at the desired tilt angle.

## LED sources

Citizen CLU series. SORAA SLE Optical Light Engine. CRI: 90, 95 | CCT: 3000K, 4000K. Other CRI and CCT options available on request.

## Optic

Lens. Narrow, medium and wide beam angle available.

## Accessories

No accessories available.

## Finish

Powder coat in white or grey colour.

## Driver

Supplied with no-dimable driver. Dimming Options: 0-10V Dim, DALI, Phase, CASAMBI.

## Applications

A modern design consisting of simple cylinders to act as heat management for the purpose to meet the highest requirements of the latest advanced lighting technology. Application areas: retail, museums, hospitality, residential, offices, lobbies.

## Related Products

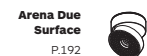
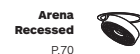

# Arena Due



## Arena Due 70 / 130

Track

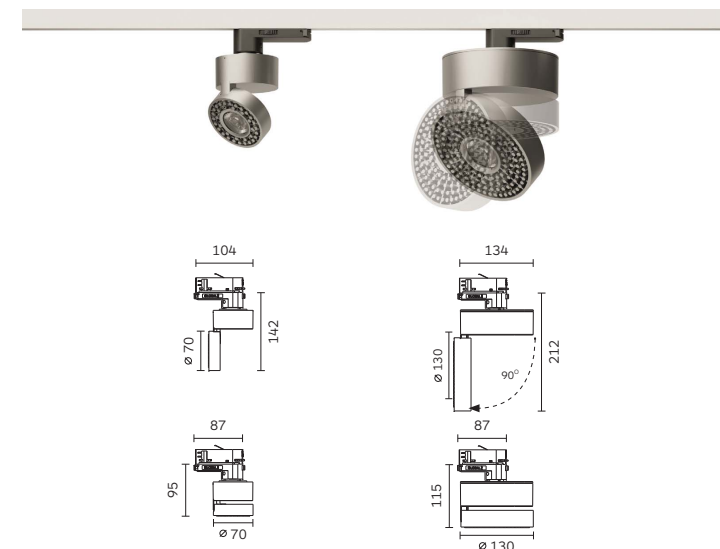

Code ordering example: **6 2 7 6 B C 3 1 - 9 0 3 0 1 9 D 0 1 1**

	Product Code	Light Source Code*	>CRI	CCT**	LED Power	Nominal Lumen	Beam Angle (BA°)	Driver Options	Finish
Arena Due 70 Track	<b>6276</b>	<b>BC31</b> Citizen COB	<b>90</b>	<b>30</b> 3000K	6W	616 lm	<b>19 / 24 / 34</b>	<b>D0</b> No Dim	<b>11</b> □ White
				<b>40</b> 4000K	643 lm	<b>DA</b> Dali Dim	<b>75</b> ■ Grey		
Arena Due 130 Track	<b>6276</b>	<b>BC22</b> Citizen COB	<b>95</b>		12W	1552 lm	<b>19 / 24 / 34</b>	<b>D0</b> No Dim	
						1577 lm	<b>DA</b> Dali Dim		
					8.7W	524 lm	<b>10</b>	<b>DP</b> Phase Dim	
					547 lm	<b>DC</b> CASAMBI			
	9.8W	739 lm	<b>15 / 25 / 36</b>	<b>D1</b> 0-10V Dim					
		775 lm							

## Notes:

\* For complete code ordering information, please see page 377.

\*\* For other CCT options, please contact us.

# Piazza LED

Designed by **Franco Mirezzi** (Registered)



## Body

Track mounted spotlight with luminaire body and driver box in cast aluminium.

Available with 3 circuit universal track adapter or Dali track adapter. Safety glass included.

Versatile aiming angle tiltable vertically 0°-90° and rotatable horizontally 350°. Possibility to lock the fixture at the desired tilt angle.

## LED sources

Cree Powerled.  
CRI: 90 | CCT: 3000K, 4000K, TuneableWhite.  
Other CRI and CCT options, RGB/W version available on request.

## Optic

Lenses.  
Narrow, medium, white and wallwasher beam angle available.

## Related Products

**Piazza LED Recessed**  
P.58



**Ola Compasso Track**  
P.132



## Accessories

No accessories available.

## Finish

Powder coat in black or white colour.

## Driver

Driver box inclusive of no-dimable driver.  
Dimming Options: 0-10V Dim, DALI, Phase, CASAMBI.

## Applications

Minimalistic and simple shape design combined with integrated heat dissipater to meet the LED light technology restricted requirements.  
Application areas: retail, museums, showrooms, residential, restaurants, hotels, window displays.

# Piazza LED



## Piazza LED 82 / 144

Track

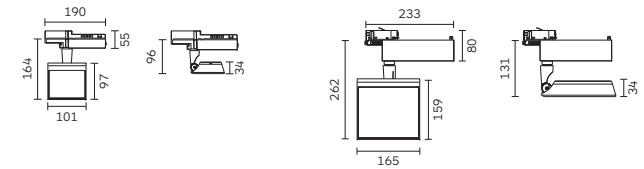

Code ordering example: **6 3 2 9 B R 1 1 - 9 0 3 0 1 0 D 0 1 0**

	Product Code	Light Source Code*	>CRI	CCT**	LED Power	Nominal Lumen	Beam Angle (BA°)	Driver Options	Finish
Piazza LED 82 Track	<b>6329</b>	<b>BR11</b> Cree 3535	<b>90</b>	<b>30</b> 3000K	12W	1395 lm	<b>10 / 23 / 46 / WW</b>	<b>DO</b> No Dim	<b>10</b> ■ Black
				<b>40</b> 4000K		1503 lm		<b>DA</b> Dali Dim	<b>11</b> □ White
				<b>TW</b> 1800-6000K	/	/		<b>DP</b> Phase Dim	<b>75</b> ■ Grey
Piazza LED 144 Track	<b>6328</b>	<b>90</b>	<b>30</b> 3000K	40W	4120 lm		<b>DC</b> CASAMBI		
			<b>40</b> 4000K		4400 lm		<b>D1</b> 0-10V Dim		
			<b>TW</b> 1800-6000K	/	/				

## Notes:

\* For complete code ordering information, please see page 377.

\*\* For other CCT options, please contact us.

# Conos

Designed by Franco Mirezzi



## Body

Track mounted spotlight with light head and arm in cast aluminium. Equipped with super pure aluminium reflector.

Available with 3 circuit universal track adapter or Dali track adapter. Easy relamping via removable front housing by snap-in catch action. Available in 3 different sizes.

Versatile aiming angle tiltable vertically 0°-90° and rotatable horizontally 350°. Possibility to lock the fixture at the desired tilt angle.

## Accessories

Honeycomb louvre, ceiling base.

## Finish

Powder coat in black, white or grey colour.

## LED sources

Citizen CLU series.  
CRI: 90, 95 | CCT: 3000K, 4000K.  
Other CRI and CCT options available on request.

## Optic

Reflector.  
Narrow, medium and wide beam angle available.

## Driver

Track adaptor inclusive of integrated no-dimable driver.  
Dimming Options: 0-10V Dim, DALI, Phase, CASAMBI.

## Applications

A concept in spotlight design with continuous line applications for the benefit of increasing the possibility of display lighting. Conos 100/68 are ideal for small spaces. Application areas: retail, museums, residential, hospitality, window displays.

### Related Products



# Conos



Conos 68 / 100 / 154  
Track



Code ordering example: **6 4 9 4 B C 2 2 - 9 0 3 0 1 6 D 0 1 0**

	Product Code	Light Source Code*	>CRI	CCT	LED Power	Nominal Lumen	Beam Angle (BA°)	Driver Options	Finish
Conos 68 Track	<b>6494</b>	<b>BC22</b>	<b>90</b>	<b>30</b> 3000K	11W	1210 lm	<b>16 / 28 / 40</b>	<b>D0</b> No Dim	<b>10</b> ■ Black
				<b>40</b> 4000K		1232 lm		<b>DA</b> Dali Dim	<b>11</b> □ White
Conos 100 Track	<b>6492</b>	<b>BC22</b>			22W	2418 lm	<b>12 / 21 / 39</b>	<b>DC</b> CASAMBI	<b>75</b> ■ Grey
Conos 154 Track	<b>6323</b>	<b>BC21</b>			30W	3728 lm	<b>14 / 24 / 38</b>		
						3785 lm			

### Notes:

\* For complete code ordering information, please see page 377.  
\*\* For other CCT options, please contact us.  
For related accessories, please see page 161.



## Conos Family configuration options

Code ordering example: 6 4 9 4 B C 2 2 - 9 0 3 0 1 6 D 0 1 0

### Conos 68

#### Track

Product Code	Light Source Code	>CRI	CCT	LED Power	Nominal Lumen	Beam Angle (BA°)	Driver Options	Finish
<b>6494</b>	<b>BC22</b> Citizen COB	<b>90</b>	<b>30</b> 3000K	11W	1210 lm	<b>16 / 28 / 40</b>	<b>D0</b> No Dim	<b>10</b> ■ Black <b>11</b> □ White <b>75</b> ■ Grey
			<b>40</b> 4000K		1232 lm		<b>DA</b> Dali Dim <b>DC</b> CASAMBI	
<b>GU53</b> Retrofit	MR16-GU5.3	<b>00</b>	<b>00</b>	/	/	<b>00</b>	<b>DP</b> Phase Dim	
<b>GU10</b>	GZ10-GU10							

### Conos 100

#### Track

Product Code	Light Source Code	>CRI	CCT	LED Power	Nominal Lumen	Beam Angle (BA°)	Driver Options	Finish
<b>6492</b>	<b>BC22</b> Citizen COB	<b>90</b>	<b>30</b> 3000K	22W	2418 lm	<b>12 / 21 / 39</b>	<b>D0</b> No Dim	<b>10</b> ■ Black <b>11</b> □ White <b>75</b> ■ Grey
			<b>40</b> 4000K		2456 lm		<b>DA</b> Dali Dim <b>DC</b> CASAMBI	

### Conos 154

#### Track

Product Code	Light Source Code	>CRI	CCT	LED Power	Nominal Lumen	Beam Angle (BA°)	Driver Options	Finish
<b>6323</b>	<b>BC21</b> Citizen COB	<b>90</b>	<b>30</b> 3000K	30W	3728 lm	<b>14 / 24 / 38</b>	<b>D0</b> No Dim	<b>10</b> ■ Black <b>11</b> □ White <b>75</b> ■ Grey
			<b>40</b> 4000K		3785 lm		<b>DA</b> Dali Dim <b>DC</b> CASAMBI	
<b>AR11</b> Retrofit	AR111-G53	<b>00</b>	<b>00</b>	/	/	<b>00</b>	<b>DP</b> Phase Dim	

#### Notes:

For other CCT options, please contact us.

## Optical Accessories

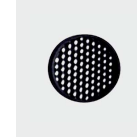

Product / Optical Accessories	Honeycomb Louvre Colour 10
Conos 68 Track	<b>2B95</b>
Conos 100 Track	<b>2368</b>
Conos 154 Track	<b>2367</b>

# Rolo & Dado

Rolo designed by Simon Fisher



## Body

Track mounted round spotlight with light-head and driver box in cast aluminium.

Available with 3 circuit universal track adapter, Dali track adapter or, for the low voltage version, mini track adapter. For retrofit version, easy relamping by the removable lamp front ring via simple snap-in catch action.

Versatile aiming angle tiltable vertically 0°-90° in two directions and rotatable horizontally 350°.

## LED sources

Citizen CLU series. SORAA SLE Optical Light Engine. CRI: 90, 95 | CCT: 3000K, 4000K. Other CRI and CCT options available on request.

## Optic

Lenses. Narrow, medium and wide beam angle available.

## Related Products



## Accessories

Honeycomb louvre, linear spread, Snap System™ accessories available for SORAA SLC series with narrow beam angle.

## Finish

Powder coat in white or grey colour.

## Driver

Driver box inclusive of no-dimable driver. Dimming Options: 0-10V Dim, DALI, Phase, CASAMBI.

## Applications

A versatile and very directional cylindrical spotlight. The very compact sizes make it ideal for applications where the distance between ceiling and spot is an issue. Application areas: retail, museums, residential, hospitality, window displays.

## Rolo



### Rolo

Eurotype Track



### Rolo

Low Voltage Track



Eurotype Track Low Voltage Track



Code ordering example: **6 2 8 8 B B 2 2 - 9 0 3 0 1 4 D 0 1 1**

	Product Code	Light Source Code*	>CRI	CCT**	LED Power	Nominal Lumen	Beam Angle (BA°)	Driver Options	Finish
Rolo Eurotype Track	<b>6288</b>	<b>BB22</b>	<b>90</b>	<b>30</b> 3000K	6W	706 lm	<b>14 / 24 / 34</b>	<b>D0</b> No Dim	<b>11</b> □ White
				<b>40</b> 4000K		757 lm		<b>DA</b> Dali Dim	<b>75</b> ■ Grey
								<b>DP</b> Phase Dim	
								<b>DC</b> CASAMBI	
								<b>D1</b> 0-10V Dim	
Rolo Low Voltage Track	<b>6093</b>	<b>GU53</b>	<b>00</b>	<b>00</b>	/	/	<b>00</b>	<b>DP</b> Phase Dim†	

### Notes:

\* For complete code ordering information, please see page 377.

\*\* For other CCT options, please contact us.

† Remote electronic dimable transformer supplied with the track, for more information see page 168. For related accessories, please see page 165.

# Dado



## Dado

Eurotype Track



## Dado

Low Voltage Track



Eurotype Track Low Voltage Track



Code ordering example: 6 2 8 7 B B 2 2 - 9 0 3 0 1 4 D 0 1 1

	Product Code	Light Source Code*	>CRI	CCT**	LED Power	Nominal Lumen	Beam Angle (BA°)	Driver Options	Finish
Dado Eurotype Track	<b>6287</b>	<b>BB22</b>	<b>90</b>	<b>30</b> 3000K	6W	706 lm	<b>14 / 24 / 34</b>	<b>D0</b> No Dim	<b>11</b> <input type="checkbox"/> White
				<b>40</b> 4000K		757 lm		<b>DA</b> Dali Dim	
								<b>DP</b> Phase Dim	
								<b>DC</b> CASAMBI	
								<b>D1</b> 0-10V Dim	
Dado Low Voltage Track	<b>6094</b>	<b>GU53</b>	<b>00</b>	<b>00</b>	/	/	<b>00</b>	<b>DP</b> Phase Dim*	

**Notes:**

- \* For complete code ordering information, please see page 377.
  - \*\* For other CCT options, please contact us.
  - \* Remote electronic dimable transformer supplied with the track, for more information see page 168.
- For related accessories, please see page 165.

# Rolo & Dado Family configuration options

Code ordering example: 6 2 8 8 B B 2 2 - 9 0 3 0 1 4 D 0 1 1

## Rolo

Product Code	Light Source Code	>CRI	CCT	LED Power	Nominal Lumen	Beam Angle (BA°)	Driver Options	Finish
<b>6288</b> Eurotype Track	<b>BB22</b> Bridgelux COB	<b>90</b>	<b>30</b> 3000K	6W	706 lm	<b>14 / 24 / 34</b>	<b>D0</b> No Dim	<b>11</b> <input type="checkbox"/> White
			<b>40</b> 4000K		757 lm		<b>DA</b> Dali Dim	
	<b>BS12</b> Soraa SLC-16	<b>95</b>		8.1W	460 lm	<b>10</b>	<b>DP</b> Phase Dim	
				12.2W	480 lm		<b>DC</b> CASAMBI	
					720 lm	<b>15 / 25 / 36</b>	<b>D1</b> 0-10V Dim	
					755 lm			
	<b>GU53</b> Retrofit MR16-GU5.3	<b>00</b>	<b>00</b>	/	/	<b>00</b>	<b>DP</b> Phase Dim	
	<b>GU10</b> GZ10-GU10							
<b>6093</b> Low Voltage Track	<b>GU53</b> MR16-GU5.3							

## Dado

Product Code	Light Source Code	>CRI	CCT	LED Power	Nominal Lumen	Beam Angle (BA°)	Driver Options	Finish
<b>6287</b> Eurotype Track	<b>BB22</b> Bridgelux COB	<b>90</b>	<b>30</b> 3000K	6W	706 lm	<b>14 / 24 / 34</b>	<b>D0</b> No Dim	<b>11</b> <input type="checkbox"/> White
			<b>40</b> 4000K		757 lm		<b>DA</b> Dali Dim	
	<b>BS12</b> Soraa SLC-16	<b>95</b>		8.1W	460 lm	<b>10</b>	<b>DP</b> Phase Dim	
				12.2W	480 lm		<b>DC</b> CASAMBI	
					720 lm	<b>15 / 25 / 36</b>	<b>D1</b> 0-10V Dim	
					755 lm			
	<b>GU53</b> Retrofit MR16-GU5.3	<b>00</b>	<b>00</b>	/	/	<b>00</b>	<b>DP</b> Phase Dim	
	<b>GU10</b> GZ10-GU10							
<b>6094</b> Low Voltage Track	<b>GU53</b> MR16-GU5.3							

# Optical Accessories

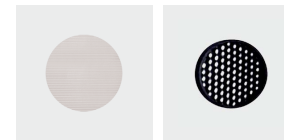

Product / Optical Accessories	Linear Spread Colour 41	Honeycomb Louvre Colour 10
Rolo & Dado Track GU5.3	<b>2362</b>	<b>2361</b>

For Soraa specific accessories, please contact us and we will provide the detailed information.

**Notes:**

For other CCT options, please contact us.

# Eurotype Track System

## Surface Mounted Track & Flanged Recessed Track

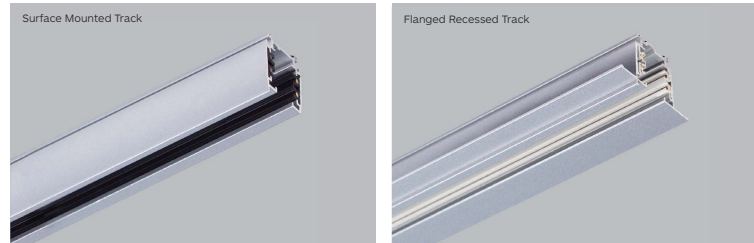

Product Code	Length (L)	Finish
<b>2089</b>	1m	<b>10</b> Black
<b>2090</b>	2m	<b>11</b> White
<b>2091</b>	3m	<b>75</b> Grey

**Notes:** Connection to the 220-250V single-phase mains: 16A overall load, corresponding to 3500/4000 VA over the three circuits.

## Features

Three circuit main-voltage track system.

Track in extruded aluminium fitted with four 16A rolled copper conductors housed in extruded insulated black thermoplastic.

Equipped with three separately controllable current circuit.

Completed of a vast range of accessories to fit to the needs of any specific project.



..... The drawing is Reflected Ceiling View.  
 ..... Directive Lug on the back of connectors.

**Reference Diagram for Choice of Connetors (Surface Mounted Track)**

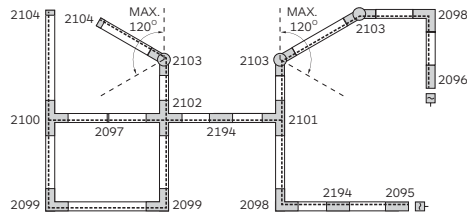

**Reference Diagram for Choice of Connetors (Flanged Recessed Track)**

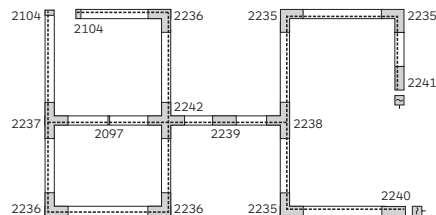

## Installation Components

<b>2105*</b>	Mechanical Coupler	
<b>2106*</b>	Ceiling Bracket	

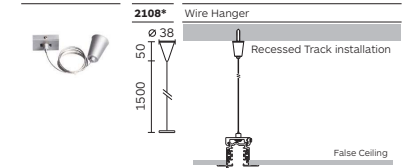

## Couplings

<b>2095**</b>	Feeder (Right) for Surface track	
<b>2096**</b>	Feeder (Left) for Surface track	
<b>2098**</b>	L Connector (Right) for Surface track	
<b>2099**</b>	L Connector (Left) for Surface track	
<b>2100**</b>	T Connector (Right) for Surface track	
<b>2101**</b>	T Connector (Left) for Surface track	
<b>2240**</b>	Feeder (Right) for Recessed track	
<b>2241**</b>	Feeder (Left) for Recessed track	
<b>2235**</b>	L Connector (Right) for Recessed track	
<b>2236**</b>	L Connector (Left) for Recessed track	
<b>2237**</b>	T Connector (Right) for Recessed track	
<b>2238**</b>	T Connector (Left) for Recessed track	
<b>2049**</b>	Ceiling base	

<b>2194**</b>	Straight Connector for Surface track	
<b>2103**</b>	Flexible Connector for Surface track	
<b>2102**</b>	X Connector for Surface track	
<b>2239**</b>	Straight Connector for Recessed track	
<b>2242**</b>	X Connector for Recessed track	
<b>2097**</b>	Concealed Connector	
<b>2104**</b>	End Cap	

**Notes:**  
 \* Available in colours 10, 11, 75.  
 \*\* Available in colours 10 & 11.

# Low Voltage Mini Track

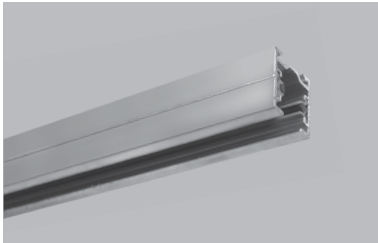

Product Code	Length (L)	Finish
2279	1m	10 ■ Black
2278	2m	11 □ White
		75 ■ Grey



## Features

Mini track low voltage (12V) system.

Made of extruded aluminium and fitted with 25 A rolled copper conductors.

Equipped with a vast range of accessories to fit to the needs of any specific project.



## Standard Couplings

2243\* 12V Live End



2244\* End Cap



2287\* 210W 12V Transformer with box  
Electronic dimmable transformer 220-240/12V  
50/60Hz for both leading-edge and phase cutting  
trailing edge dimmer.



2285\* Concealed Connector



2286\* Flexible Connector



2288\* Suspension Kit



### Notes:

- \* Available in colour 11

# Mago

Surface 115 | 145



## Body

Round shape surface mounting luminaire in cast aluminium with brackets for trim installation on ceiling thickness max. 25 mm or trimless installation on ceiling thickness max. 30 mm.

Luminaire body in cast aluminium inclusive of a convex lens.

## LED sources

Citizen CLU Series.  
CRI: 90, 95, 98 | CCT: 2700K, 3000K, 4000K.  
Other CRI and CCT options, Tuneable White and DimToWarm versions available on request.

### Related Products

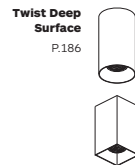

## Accessories

No accessories available.

## Finish

Powder coat in black and white colour.

## Optic

Convex Lens.  
Narrow, medium and wide beam angle available.

## Driver

Supplied with integrated no-dimable driver.  
Dimming Options: 0-10V Dim, DALI, Phase, CASAMBI.

## Applications

The revolutionary convex lens provides an evenly and effective light minimizing the glare. Its affordable price combine with its wide light distribution, make it the ideal solution for a vast range of architectural applications.  
Application areas: office, hotels, restaurants, lobbies, corridors, conference rooms.

# Mago



**Mago 115 / 145**  
Surface

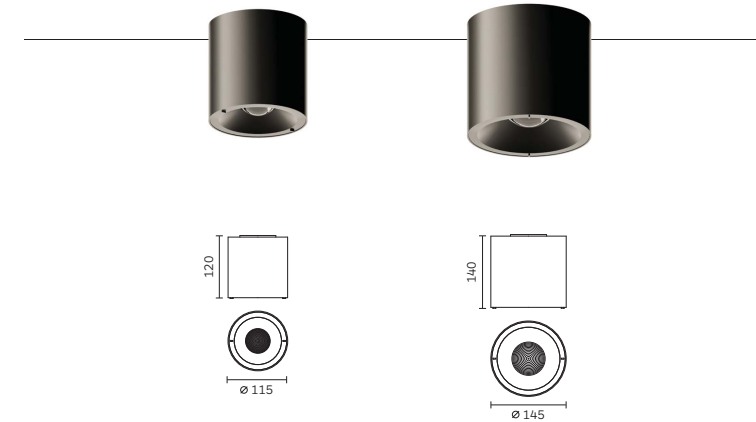

Code ordering example: **1 3 8 2 B C 2 2 - 9 0 3 0 4 0 D 0 1 0**

	Product Code	Light Source Code*		>CRI	CCT**	LED Power	Nominal Lumen	Beam Angle (BA°)	Driver Options	Finish	
Mago 115 Surface	<b>1382</b>	<b>BC22</b>	Citizen	COB	<b>90</b>	<b>30</b> 3000K	12W	1500 lm	<b>40</b>	<b>DO</b> No Dim	<b>10</b> ■ Black
						<b>40</b> 4000K		1600 lm		<b>DA</b> Dali Dim	<b>11</b> □ White
Mago 145 Surface	<b>1383</b>	<b>BC33</b>	Citizen	COB	<b>90</b>		21W	2200 lm	<b>45</b>	<b>DP</b> Phase Dim	
								2350 lm		<b>DC</b> CASAMBI	
											<b>D1</b> 0-10V Dim

### Notes:

\* For complete code ordering information, please see page 377.

\*\* For other CCT options, please contact us.

# Pixo

Surface 36 | 77



## Body

Ceiling mounted luminaire with light body in extruded aluminium.

Light body available in two diameter (36mm and 77mm).

Exchangable front ring in wide range of colours. Available in two sizes and three different lengths.

## LED sources

Bridgelux Vero series.

CRI: 90 | CCT: 3000K, 4000K, TuneableWhite.

Other CRI and CCT options available on request.

## Related Products

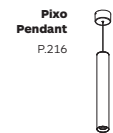

## Optic

Reflector.

Narrow, medium and wide beam angle available.

## Accessories

Decorative ring available in different colours. Transparent acrylic decorative diffuser.

## Driver

Supplied with integrated no-dimable driver.

Dimming Options: 0-10V Dim, Phase, CASAMBI, available for Pixo 77.

## Finish

Powder coat in black or white. Exchangable front ring in different colours.

## Applications

A modern designed surface ambient light. Its accessories make it the perfect match for sophisticated environments. Application areas: residential, hotels, restaurants, retail, corridors.

# Pixo



## Pixo 36 / 77

Surface

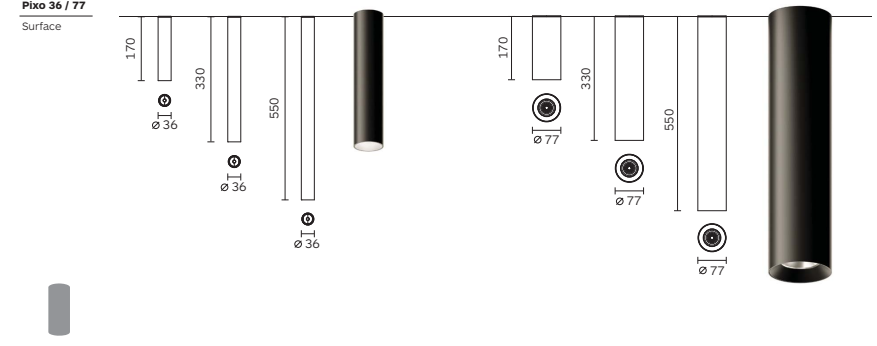

Code ordering example: **1 3 8 7 B B 2 2 - 9 0 3 0 2 0 D 0 1 0**

	Product Code	Product Length	Light Source Code*	>CRI	CCT**	LED Power	Nominal Lumen	Beam Angle (BA°)	Driver Options	Finish
Pixo 36 Surface	<b>1387</b>	170	<b>BB22</b> Bridgelux COB	<b>90</b>	<b>30</b> 3000K	6W	730 lm	<b>20 / 44</b>	<b>D0</b> No Dim	<b>10</b> ■ Black
	<b>1389</b>	330			<b>40</b> 4000K		782 lm			<b>11</b> □ White
	<b>1391</b>	550								
Pixo 77 Surface	<b>1388</b>	170	<b>BB12</b>			11W	1364 lm	<b>16 / 30</b>	<b>D0</b> No Dim	
	<b>1390</b>	330					1460 lm		<b>DP</b> Phase Dim	
	<b>1392</b>	550							<b>DC</b> CASAMBI <b>D1</b> 0-10V Dim	

## Optical Accessories

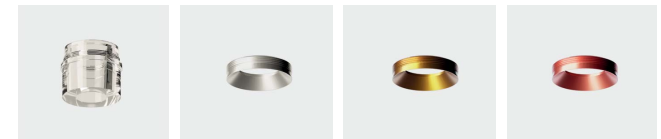

Product / Optical Accessories	Acrylic diffuser	Colour Ring Colour 33	Colour Ring Colour 35	Colour Ring Colour 55
Pixo 36	<b>2C36</b>	<b>2C34</b>	<b>2C34</b>	<b>2C34</b>
Pixo 77	<b>2C35</b>	<b>2C33</b>	<b>2C33</b>	<b>2C33</b>

### Notes:

\* For complete code ordering information, please see page 377.

\*\* For other CCT options, please contact us.

# Vela

Designed by Alberto Fraser



## Body

Wall mounted luminaire with body and driver canopy laser cut sheet aluminium. Lamp inclusive of transparent safety cover for the light source in extruded acrylic.

Engineering design for passive cooling. Easy, safe and fast wall assembly with a hidden lateral screw holder. Can be positioned on the wall in diverse configurations, according with the needs of the project.

## LED sources

Samsung SMD Series.  
CRI: 90 | CCT: 3000K, 4000K.  
Other CRI and CCT option available on request.

## Related Products



## Optic

Equipped with acrylic satin opal diffuser.

## Accessories

No accessories available.

## Driver

Supplied with integrated no-dimable driver.  
Dimming Options: 0-10V Dim, Phase, CASAMBI

## Finish

Powder coat in white colour.

## Applications

High-end design decorative wall lamp, due to its minimal and elegant design and choice of color tone finishes. Incorporates well into any hospitality and work environment. The light tone emitted is both pleasant and uniform.  
Application areas: hospitality, corridors, bathrooms, lobbies, waiting rooms.

# Vela



**Vela**  
Surface

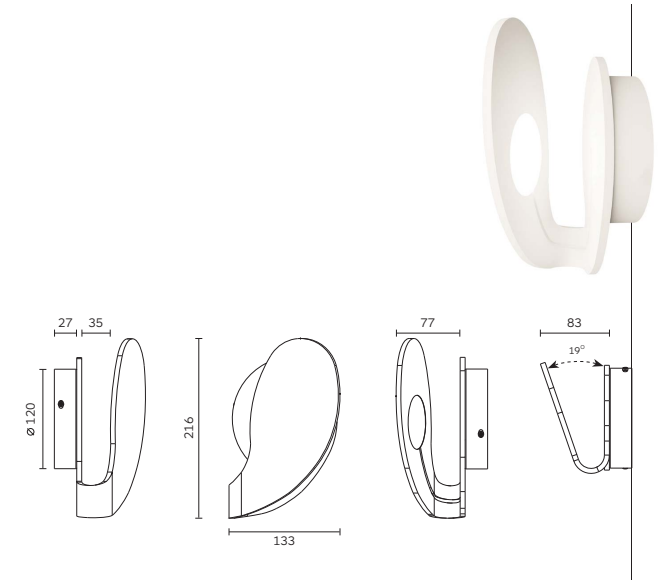

Code ordering example: **1 3 9 3 B M 1 1 - 9 0 3 0 0 0 D 0 1 0**

	Product Code	Light Source Code*	>CRI	CCT**	LED Power	Nominal Lumen	Beam Angle (BA°)	Driver Options	Finish
Vela Surface	<b>1393</b>	<b>BM11</b> Samsung SMD	<b>90</b>	<b>30</b> 3000K	6W	600 lm	EW ( <b>00</b> )	<b>D0</b> No Dim	<b>10</b> ■ Black
				<b>40</b> 4000K		650 lm		<b>DP</b> Phase Dim	<b>11</b> □ White
								<b>DC</b> CASAMBI	
								<b>D1</b> 0-10V Dim	

## Notes:

\* For complete code ordering information, please see page 377.

\*\* For other CCT options, please contact us.

EW = Extra Wide. Ordering code: **00**.



# Polaris

Surface 30



## Body

Surface mounted luminaire with light body in extruded aluminium inclusive of integrated diamond faceted no-dazzle louvre in thermoplastic.

Surface Mounted arm(s) in cast aluminium. Light body measuring 45mm in width and 65mm in height. Available in configuration with 8, 12, 16 and 36 light heads.

Light heads collectively tiltable in two directions from 0° to 90° trough the surface mounted arm(s).

## Accessories

No accessories available.

## Finish

Light body powder coat in black or white finish. Integrated louvre available in black or white finish.

## LED sources

Osram Oslon Square high power led  
CRI: 90 | CCT: 3000K, 4000K, TuneableWhite.  
Other CRI and CCT options available on request.

## Optic

Reflector: Medium and wide beam angle available.  
Louvre available in black or white finish.  
UGR<13 for a better visual comfort.

## Driver

Inclusive of integrated no-dimable driver.  
Dimming Options: 0-10V Dim, DALI, Phase, CASAMBI.

## Applications

An innovative solution for high brilliance and performance. The light source is barely visible, as the miniature light heads create a high contrast and circular light emission.  
Application areas: residential, hotels, restaurants, retail, corridors.

### Related Products

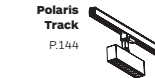
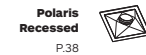

# Polaris



## Polaris 30

Surface 8 / 12 / 16 / 36

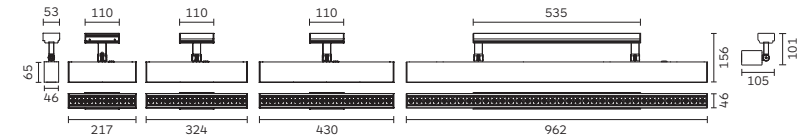

Code ordering example: **1 3 5 0 B 0 1 1 - 9 0 3 0 3 4 D 0 1 0**

	Product Code	Light Source Code*	>CRI	CCT**	LED Power	Nominal Lumen	Beam Angle (BA°)	Driver Options	Finish
Polaris 30 Surface 8	<b>1350</b>	<b>B011</b> Osram 3030	<b>90</b>	<b>30</b> 3000K	8x2W	1520 lm	<b>34 / 50</b>	<b>D0</b> No Dim	<b>10</b> ■ Black
				<b>40</b> 4000K		1920 lm			<b>11</b> □ White
Polaris 30 Surface 12	<b>1351</b>				12x2W	2280 lm		<b>D0</b> No Dim	<b>17</b> ▣ B/W
						2880 lm		<b>DA</b> Dali Dim	
Polaris 30 Surface 16	<b>1346</b>				16x2W	3040 lm		<b>DC</b> CASAMBI	
						3840 lm		<b>D1</b> 0-10V Dim	
Polaris 30 Surface 36	<b>1345</b>				36x2W	6840 lm			
						8640 lm			

### Notes:

\* For complete code ordering information, please see page 377.

\*\* For other CCT options, please contact us.

**17:** white light body with black integrated louvre. For black body with white integrated louvre consult us.

# Zero Due

Surface 66 | 100 | 130



## Body

Ceiling and wall mounted spotlight with light body and driver canopy in cast aluminium. Inclusive of reflector in metalized PC.

Light body is designed for passive cooling. Available in 3 different sizes.

Tiltable vertically 0-90° and rotatable horizontally 360°.

## LED sources

Citizen CLU Series. Xicato Artist, Beauty and Designer Series. SORAA SLC Optical Light Engine. CRI: 90, 95, 98 | CCT: 2700K, 3000K, 4000K. Other CRI and CCT options, Tuneable White and DimToWarm versions available on request.

## Optic

Reflector. Narrow, medium and wide beam angle available.

## Accessories

Coloured filters, linear spread, honeycomb louvre, visor. Snap System™ accessories available for SORAA SLC series with narrow beam angle.

## Finish

Powder coat in black and white colour.

## Driver

Driver canopy inclusive of no-dimable driver. Dimming Options: 0-10V Dim, DALI, Phase, CASAMBI. The shape of the box may change according with the chosen dimming options.

## Applications

A modern design consisting for the purpose to meet the highest requirements of the latest advanced lighting technology. Application areas: retail, museums, hospitality, residential, offices, lobbies.

## Related Products

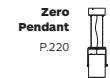
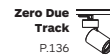

# Zero Due



## Zero Due 66 / 100 / 130

Surface

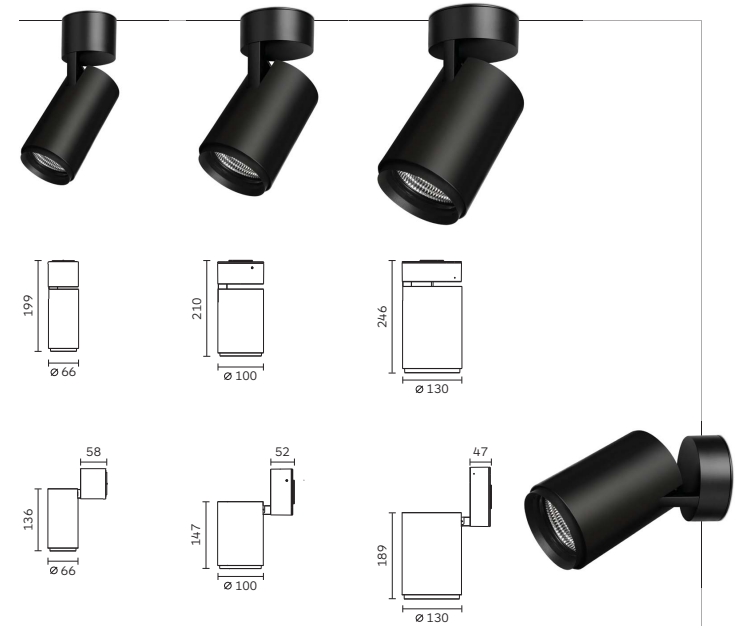

Code ordering example: **1 3 3 4 B C 3 2 - 9 0 3 0 1 5 D 0 1 0**

	Product Code	Light Source Code*	>CRI	CCT**	LED Power	Nominal Lumen	Beam Angle (BA°)	Driver Options	Finish
Zero Due 66 Surface	<b>1334</b>	<b>BC32</b>	<b>90</b>	<b>30</b> 3000K	12W	1357 lm	<b>15 / 23 / 45</b>	<b>D0</b> No Dim	<b>10</b> ■ Black
				<b>40</b> 4000K		1414 lm		<b>DP</b> Phase Dim	<b>11</b> □ White
Zero Due 100 Surface	<b>1331</b>	<b>BC33</b>			33W	3114 lm	<b>12 / 27 / 55</b>	<b>D0</b> No Dim	
					3245 lm	<b>DA</b> Dali Dim			
Zero Due 130 Surface	<b>1328</b>	<b>BC34</b>			45W	3978 lm	<b>10 / 18 / 42</b>	<b>DP</b> Phase Dim	
					4144 lm	<b>DC</b> CASAMBI		<b>D1</b> 0-10V Dim	

## Notes:

\* For complete code ordering information, please see page 377.

\*\* For other CCT options, please contact us.

For related accessories, please see page 181.

## Zero Due Surface Family configuration options

Code ordering example: 1334 BC32 - 90 30 15 D0 10

### Zero Due 66

#### Ceiling & Wall

Product Code	Light Source Code	>CRI	CCT	LED Power	Nominal Lumen	Beam Angle (BA°)	Driver Options	Finish
<b>1334</b>	<b>BC32</b> Citizen COB	<b>90</b>	<b>30</b> 3000K	12W	1357 lm	<b>15 / 23 / 45</b>	<b>D0</b> No Dim	<b>10</b> ■ Black <b>11</b> □ White
			<b>40</b> 4000K		1414 lm			
<b>BS12</b> Soraa	SLC-16	<b>95</b>		10W	500 lm	<b>10 / 25 / 36</b>		
					525 lm			
<b>BX25</b> Xicato	Artist XTM	<b>98</b>	<b>27</b> 2700K	20W	1700 lm	<b>30 / 42 / 55</b>		
			<b>95</b>		2000 lm			
<b>BX32</b>	Beauty XTM	<b>95</b>				<b>28 / 35 / 45</b>		
<b>BX42</b>	Designer XTM	<b>90</b>		17W				

### Zero Due 100

#### Ceiling & Wall

Product Code	Light Source Code	>CRI	CCT	LED Power	Nominal Lumen	Beam Angle (BA°)	Driver Options	Finish
<b>1331</b>	<b>BC33</b> Citizen COB	<b>90</b>	<b>30</b> 3000K	33W	3114 lm	<b>12 / 27 / 55</b>	<b>D0</b> No Dim	<b>10</b> ■ Black <b>11</b> □ White
			<b>40</b> 4000K		3245 lm			
<b>BS11</b> Soraa	SLC-30	<b>95</b>		20W	1200 lm	<b>09 / 25 / 36</b>	<b>DP</b> Phase Dim	
					1300 lm			
<b>BX26</b> Xicato	Artist XTM	<b>98</b>	<b>27</b> 2700K	31W	2140 lm	<b>20 / 40 / 60</b>	<b>D1</b> 0-10V Dim	
			<b>90</b>		26W			
<b>BX43</b>	Designer XTM	<b>90</b>						

### Zero Due 130

#### Ceiling & Wall

Product Code	Light Source Code	>CRI	CCT	LED Power	Nominal Lumen	Beam Angle (BA°)	Driver Options	Finish
<b>1328</b>	<b>BC34</b> Citizen COB	<b>90</b>	<b>30</b> 3000K	45W	3978 lm	<b>10 / 18 / 42</b>	<b>D0</b> No Dim	<b>10</b> ■ Black <b>11</b> □ White
			<b>40</b> 4000K		4144 lm			
<b>BX18</b> Xicato	Standard XTM	<b>83</b>	<b>27</b> 2700K	31W	3850 lm	<b>20 / 40 / 60</b>	<b>DP</b> Phase Dim	
			<b>90</b>		42W			
<b>BX44</b>	Designer XTM	<b>90</b>			4500 lm		<b>DC</b> CASAMBI	
							<b>D1</b> 0-10V Dim	

#### Notes:

For other CCT options, please contact us.

## Optical Accessories

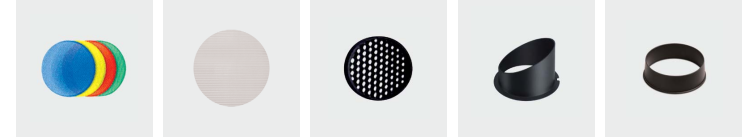

Product / Optical Accessories	Coloured Filters Colours 25, 42, 55, 85	Linear Spread Colour 41	Honeycomb Louvre Colour 10	Visor Colours 10, 17	Snoot Colours 10, 17
Zero Due 66 Ceiling / Wall	<b>2A48*</b>	<b>2A51</b>	<b>2A54</b>	<b>2A60</b>	<b>2A65</b>
Zero Due 100 Ceiling / Wall	<b>2A47*</b>	<b>2A50</b>	<b>2A53</b>	<b>2A64</b>	<b>2A59</b>
Zero Due 130 Ceiling / Wall	<b>2A46*</b>	<b>2A49</b>	<b>2A52</b>	<b>2A63</b>	<b>2A58</b>

\* With holder

# Palla

Surface 70 | 100 | 130



## Body

Ceiling and wall mounted spotlight with light body, mounting arm and driver canopy in cast aluminium.

Light body is designed for passive cooling. Available in 3 different sizes.

Light head tiltable vertically 0-90° into directions and rotatable horizontally 360°.

## LED sources

Citizen CLU Series. Xicato Artist, Beauty and Designer Series. SORAA SLC Optical Light Engine.  
CRI: 90, 95, 98 | CCT: 2700K, 3000K, 4000K.  
Other CRI and CCT options, Tuneable White and DimToWarm versions available on request.

## Optic

Lens.  
Narrow, medium and wide beam angle available.

## Accessories

Honeycomb louvre, anti glare hood, snoot, visor. Snap System™ accessories available for SORAA SLC series with narrow beam angle.

## Finish

Powder coat in black and white colour.

## Driver

Driver canopy supplied with no-dimable driver.  
Dimming Options: 0-10V Dim, DALI, Phase, CASAMBI.

## Applications

A crisp high tech designed ideal for both direct and indirect lighting applications and it integrates well with virtually any interior while offering excellent and different beam lighting distribution.

Application areas: retail, hotels, restaurants, offices, lobbies.

## Related Products

**Palla In & Out Recessed**  
P.28



**Palla Compasso Track**  
P.146



**Palla Pendant**  
P.224



# Palla



## Palla 70 / 100 / 130

Surface

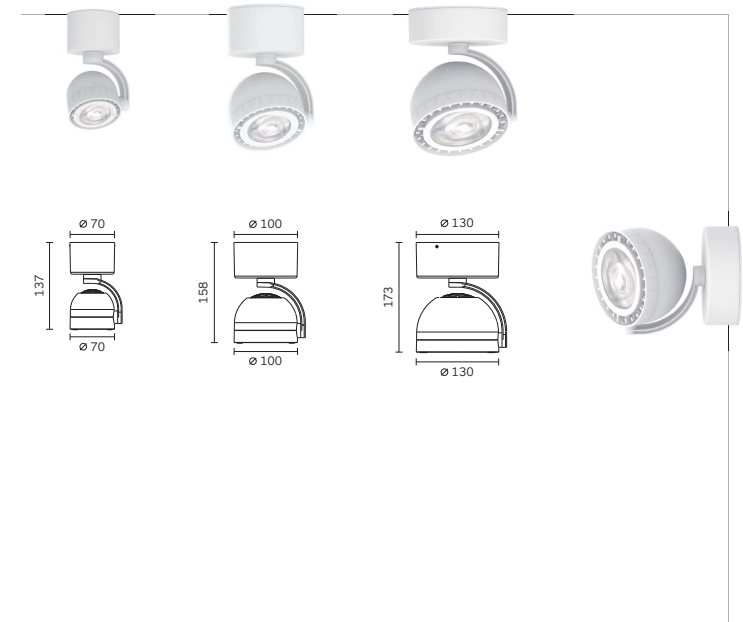

Code ordering example: **1 3 7 9 B C 2 2 - 9 0 3 0 1 6 D 0 1 0**

	Product Code	Light Source Code*	>CRI	CCT**	LED Power	Nominal Lumen	Beam Angle (BA°)	Driver Options	Finish
Palla 70 Surface	<b>1379</b>	<b>BC22</b>	<b>90</b>	<b>30</b> 3000K	12W	1500 lm	<b>16 / 25 / 36</b>	<b>D0</b> No Dim	<b>10</b> ■ Black
				<b>40</b> 4000K		1550 lm		<b>DP</b> Phase Dim	<b>11</b> □ White
Palla 100 Surface	<b>1380</b>	<b>BC33</b>			21W	2200 lm	<b>15 / 24 / 38</b>	<b>D0</b> No Dim	
						2300 lm		<b>DP</b> Phase Dim	
Palla 130 Surface	<b>1381</b>	<b>BC33</b>			33W	3220 lm	<b>12 / 22 / 32</b>	<b>DC</b> CASAMBI	
						3300 lm		<b>D1</b> 0-10V Dim	

## Notes:

\* For complete code ordering information, please see page 377.

\*\* For other CCT options, please contact us.

For related accessories, please see page 185.

## Palla Surface Family configuration options

Code ordering example: 1379 BC22 - 90 30 16 D0 10

### Palla 70

#### Ceiling & Wall

Product Code	Light Source Code	>CRI	CCT	LED Power	Nominal Lumen	Beam Angle (BA°)	Driver Options	Finish
<b>1379</b>	<b>BC22</b> Citizen COB	<b>90</b>	<b>30</b> 3000K	12W	1500 lm	<b>16 / 25 / 38</b>	<b>D0</b> No Dim	<b>10</b> ■ Black <b>11</b> □ White
			<b>40</b> 4000K		1550 lm			
	<b>BS12</b> Soraa SLC-16	<b>95</b>		10W	500 lm	<b>10 / 25 / 36</b>		
					525 lm			

### Palla 100

#### Ceiling & Wall

Product Code	Light Source Code	>CRI	CCT	LED Power	Nominal Lumen	Beam Angle (BA°)	Driver Options	Finish
<b>1380</b>	<b>BC33</b> Citizen COB	<b>90</b>	<b>30</b> 3000K	21W	2200 lm	<b>15 / 24 / 38</b>	<b>D0</b> No Dim	<b>10</b> ■ Black <b>11</b> □ White
			<b>40</b> 4000K		2300 lm			
	<b>BS12</b> Soraa SLC-16	<b>95</b>		14W	800 lm	<b>10 / 25 36</b>	<b>DC</b> CASAMBI	
					850 lm		<b>D1</b> 0-10V Dim	
	<b>BX25</b> Xicato Artist XTM	<b>98</b>	<b>27</b> 2700K	13W	1400 lm	<b>16 / 28 / 38</b>		
	<b>BX31</b> Beauty XTM	<b>95</b>		10W	931 lm	<b>28 / 35 / 45</b>		
	<b>BX41</b> Designer XTM	<b>90</b>		11W	1300 lm			

### Palla 130

#### Ceiling & Wall

Product Code	Light Source Code	>CRI	CCT	LED Power	Nominal Lumen	Beam Angle (BA°)	Driver Options	Finish
<b>1381</b>	<b>BC33</b> Citizen COB	<b>90</b>	<b>30</b> 3000K	33W	3220 lm	<b>15 / 24 / 32</b>	<b>D0</b> No Dim	<b>10</b> ■ Black <b>11</b> □ White
			<b>40</b> 4000K		3300lm			
	<b>BS22</b> Soraa SLC-30	<b>95</b>		20W	1200 lm	<b>09 / 25 / 36</b>	<b>DC</b> CASAMBI	
					1300 lm		<b>D1</b> 0-10V Dim	
	<b>BX25</b> Xicato Artist XTM	<b>98</b>	<b>27</b> 2700K	20W	2000 lm	<b>16 / 28 / 38</b>		
	<b>BX31</b> Beauty XTM	<b>95</b>				<b>28 / 35 / 45</b>		
	<b>BX41</b> Designer XTM	<b>90</b>		26W	3000 lm			

#### Notes:

For other CCT options, please contact us.

## Optical Accessories



Product / Optical Accessories	Honeycomb Louvre Colour 10	Visor Colours 10, 17	Snoot Colours 10, 17	Anti-glare Tube Colours 10, 17
Palla 70 Surface	<b>2B95</b>	<b>2B98</b>	<b>2B96</b>	<b>2B97</b>
Palla 100 Surface	<b>2B99</b>	<b>2C03</b>	<b>2C01</b>	<b>2C02</b>
Palla 130 Surface	<b>2C04</b>	<b>2C07</b>	<b>2C05</b>	<b>2C06</b>

For SORAA specific accessories, please contact us and we will provide the detailed information.

# Twist & Twist Deep

## Surface



## Body

Ceiling mounted downlight with light body in cast aluminium. Quick and easy installation and relamping via snap-in catch action.

**Twist:** tiltable vertically 0-20° and routable horizontally 350°.

**Twist Deep fixed:** internal aluminium light body shape with black baffle. Decorative colour ring in cast aluminium. Decorative transparent extension in thermoplastic.

**Twist Deep adjustable:** tiltable vertically 0-30° and routable horizontally 350°.

## LED sources

Citizen CLU series.  
CRI: 90, 95 | CCT: 3000K, 4000K.  
Other CRI and CCT options available on request.

## Optic

Lens.  
Narrow, medium and wide beam angle available.

## Accessories

**Twist Deep COB:** Decorative ring available in different colours. Decorative transparent extension ring.

## Driver

Supplied with integrated no-dimable driver.  
Dimming Options: 0-10V Dim, DALI, Phase, CASAMBI.

## Finish

Powder coat in black, white and grey colour.

## Applications

Series of ceiling mounted luminaires with simple design used to provide ambient or accent lighting. Ideal to be installed in concrete ceilings or restricted voids. Able to direct the light where required.  
Application areas: residential, retail, galleries, restaurants, hotels, lobbies, corridors.

# Twist Round & Square



**Twist**  
Surface Round & Square

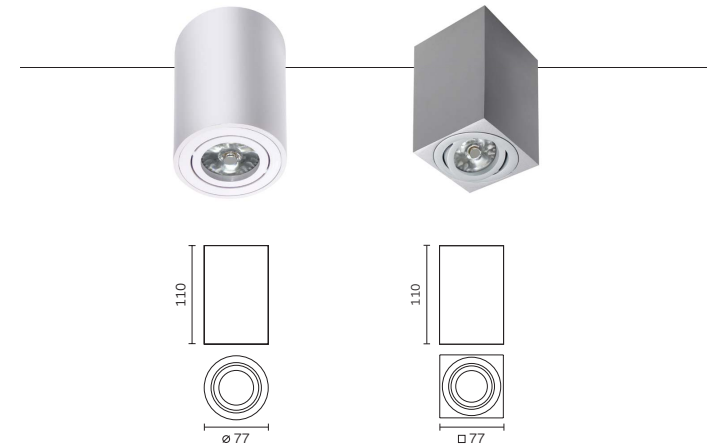

## Related Products

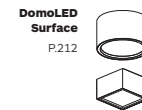

Code ordering example: **1 0 2 1 G U 1 0 - 0 0 0 0 0 0 1 0**

	Product Code	Light Source Code*	>CRI	CCT**	LED Power	Nominal Lumen	Beam Angle (BA°)	Driver Options	Finish
Twist Surface Round	<b>1021</b>	<b>GU10</b>	<b>00</b>	<b>00</b>	/	/	<b>00</b>	<b>00</b> No Driver	<b>10</b> ■ Black <b>11</b> □ White
Twist Surface Square	<b>1020</b>								

## Notes:

\* For complete code ordering information, please see page 377.

\*\* For other CCT options, please contact us.

For related accessories, please see page 191.

# Twist Deep Round & Square

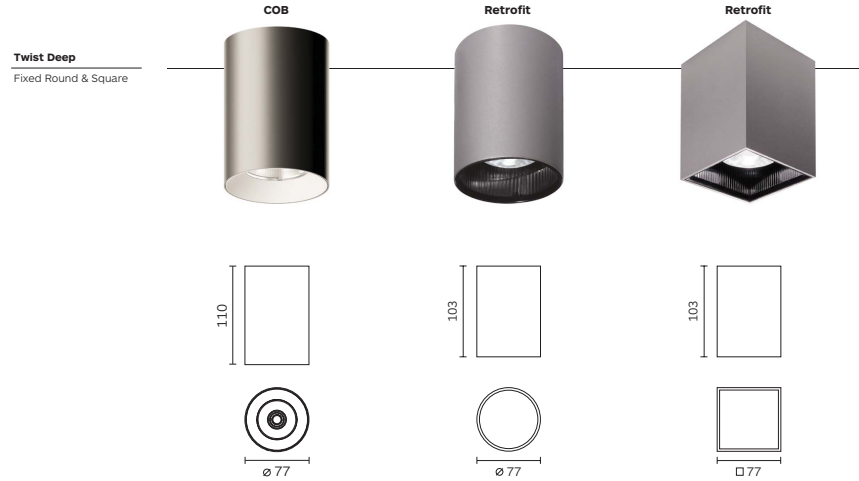

Code ordering example: **1 3 6 7 B C 2 2 - 9 0 3 0 1 6 D 0 1 0**

	Product Code	Light Source Code*	>CRI	CCT	LED Power	Nominal Lumen	Beam Angle (BA°)	Driver Options	Finish
Twist Deep Fixed Round	<b>1367</b>	<b>BC22</b>	<b>90</b>	<b>30</b> 3000K	12W	1380 lm	<b>16 / 24 / 40</b>	<b>D0</b> No Dim	<b>10</b> ■ Black
				<b>40</b> 4000K		1425 lm		<b>D1</b> 0-10V Dim	<b>11</b> □ White
Twist Deep Fixed Square	<b>1024</b>	<b>GU10</b>	<b>00</b>	<b>00</b>	/	/	<b>00</b>	<b>00</b> No Driver	
	<b>1025</b>								

**Notes:**  
 \* For complete code ordering information, please see page 377.  
 \*\* For other CCT options, please contact us.  
 For related accessories, please see page 191.

# Twist Deep Round & Square

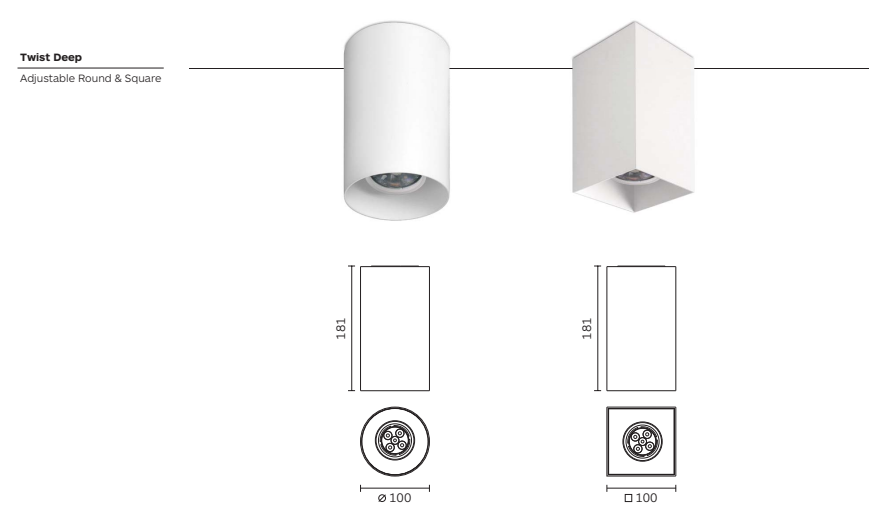

Code ordering example: **1 1 7 7 G U 5 3 - 0 0 0 0 0 0 D P 1 0**

	Product Code	Light Source Code*	>CRI	CCT**	LED Power	Nominal Lumen	Beam Angle (BA°)	Driver Options	Finish
Twist Deep Adjustable Round	<b>1177</b>	<b>GU53</b>	<b>00</b>	<b>00</b>	/	/	<b>00</b>	<b>DP</b> Phase Dim	<b>10</b> ■ Black
									<b>11</b> □ White
Twist Deep Adjustable Square	<b>1195</b>								

**Notes:**  
 \* For complete code ordering information, please see page 377.  
 \*\* For other CCT options, please contact us.  
 For related accessories, please see page 191.

## Twist Surface Family configuration options

Code ordering example: 1021 GU10 - 00 00 00 00 10

### Twist / Twist Deep Round & Square

Ceiling

Product Code	Light Source Code	>CRI	CCT	LED Power	Nominal Lumen	Beam Angle (BA°)	Driver Options	Finish
<b>1021</b> <input checked="" type="radio"/> Twist	<b>GU10</b> Retrofit MR16-GU10	<b>00</b>	<b>00</b>	/	/	<b>00</b>	<b>00</b> No Driver	<b>10</b> <input checked="" type="checkbox"/> Black
<b>1020</b> <input type="checkbox"/> Twist								<b>11</b> <input type="checkbox"/> White
<b>1024</b> <input checked="" type="radio"/> Twist Deep Fixed							<b>D0</b> No Dim	
<b>1025</b> <input type="checkbox"/> Twist Deep Fixed								
<b>1177</b> <input checked="" type="radio"/> Twist Deep Adjustable	<b>GU53</b> Retrofit MR16-GU5.3						<b>DP</b> Phase Dim	
<b>1195</b> <input type="checkbox"/> Twist Deep Adjustable								
<b>1367</b> <input checked="" type="radio"/> Twist Deep Fixed	<b>BC22</b> Citizen COB	<b>90</b>	<b>30</b> 3000K	12W	1380 lm	<b>16 / 24 / 40</b>	<b>D0</b> No Dim	
			<b>40</b> 4000K		1425 lm		<b>D1</b> 0-10V Dim	

## Optical Accessories

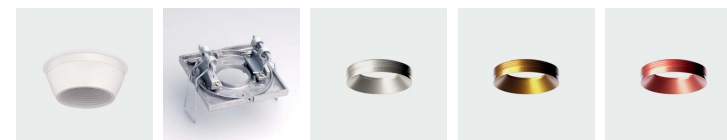

Product / Optical Accessories	Anti-Glare Hood Colours 10, 17, 75	* Semi Recessed Kit Colour 10	Colour Ring Colour 33	Colour Ring Colour 35	Colour Ring Colour 55
Twist Round / Square	<b>2675</b>	<b>2233 / 2232</b>	/	/	/
Twist Deep Fixed COB Fixed Round / Square	/	/	<b>2C33</b>	<b>2C33</b>	<b>2C33</b>

\* Semi Recessed Kit for Usage of GU5.3 MR16 LED. Transformer not included. To be ordered separately.

### Notes:

For other CCT options, please contact us.



# Arena

Surface 70 | 130



## Body

Wall/ceiling mounted luminaire with light body in cast aluminium designed with integrated heat-sink for a passive heat dissipation. Available in two sizes.

Equipped with pull-out mechanism, tiltable vertically 0-90° and rotatable horizontally 350°. Fixture can be easily locked at the chosen angle.

## LED sources

Citizen CLU series. SORAA SLE Optical Light Engine. CRI: 90, 95 | CCT: 3000K, 4000K. Other CRI and CCT options available on request.

### Related Products

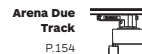
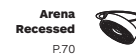

## Optic

Lens.  
Narrow, medium and wide beam angle available.

## Driver

Driver canopy supplied with No-dimable driver.  
Dimming Options: 0-10V Dim, DALI, Phase, CASAMBI.

## Accessories

No accessories available.

## Finish

Powder coat in white or grey colour.

## Applications

Its crisp high tech design integrates well with virtually any interior while offering excellent aiming flexibility. When mounted on the wall it makes an ideal indirect light fixture. Application areas: museums, retail, hospitality, office lobbies.

# Arena



**Arena 70 / 130**  
Surface

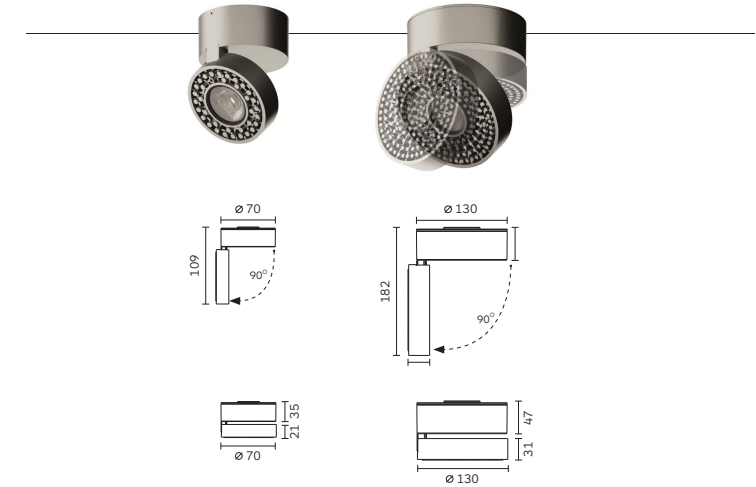

Code ordering example: **1 1 5 2 B C 3 1 - 9 0 3 0 1 9 D 0 1 1**

	Product Code	Light Source Code*		>CRI	CCT**	LED Power	Nominal Lumen	Beam Angle (BA°)	Driver Options	Finish
Arena 70 Surface	<b>1152</b>	<b>BC31</b> Citizen COB		<b>90</b>	<b>30</b> 3000K	6W	616 lm	<b>19 / 24 / 34</b>	<b>D0</b> No Dim	<b>11</b> White
					<b>40</b> 4000K		643 lm		<b>DP</b> Phase Dim	<b>75</b> Grey
Arena 130 Surface	<b>1151</b>	<b>BC22</b> Citizen COB				12W	1552 lm	<b>19 / 24 / 34</b>	<b>D0</b> No Dim	
							1577 lm		<b>DA</b> Dali Dim	
		<b>BS12</b> Soraa SLC-16		<b>95</b>		8.7W	524 lm	<b>10</b>	<b>DP</b> Phase Dim	
							547 lm		<b>DC</b> CASAMBI	
						9.8W	739 lm	<b>15 / 25 / 36</b>	<b>D1</b> 0-10V Dim	
							775 lm			

### Notes:

\* For complete code ordering information, please see page 377.

\*\* For other CCT options, please contact us.

# Rolo & Dado

## Surface



## Body

Wall/ceiling mounted spotlight with light body and driver box in cast aluminium.

For retrofit version, easy relamping by the removable lamp front ring via simple snap-in catch action.

Tilttable vertically 0-90° and routable horizontally 350°.

## LED sources

Citizen CLU series. SORAA SLE Optical Light Engine.  
CRI: 90, 95 | CCT: 3000K, 4000K.  
Other CRI and CCT options available on request.

## Optic

Lens.  
Narrow, medium and wide beam angle available.

## Accessories

Linear spread, honeycomb louvre, Snap System™ accessories available for SORAA SLC series with narrow beam angle.

## Driver

Driver box inclusive of no-dimable driver.  
Dimming Options: 0-10V Dim, DALI, Phase, CASAMBI.

## Finish

Powder coat in white or grey colour.

## Applications

A versatile and very directional cylindrical spotlight. The very compact sizes make it ideal for applications where the distance between ceiling and spot is an issue.  
Application areas: retail, museums, residential, hospitality, window displays.

## Related Products

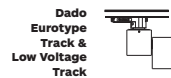

P.162-165

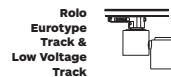

P.162-165

## Rolo



Rolo  
Surface

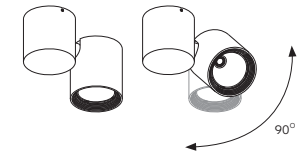
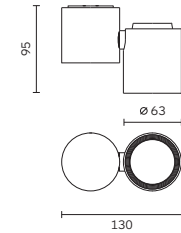

Code ordering example: **1 1 5 9 B B 2 2 - 9 0 3 0 1 4 D 0 1 1**

	Product Code	Light Source Code*	>CRI	CCT**	LED Power	Nominal Lumen	Beam Angle (BA°)	Driver Options	Finish
Rolo Surface	<b>1159</b>	<b>BB22</b>	<b>90</b>	<b>30</b> 3000K	6W	706 lm	<b>14 / 24 / 34</b>	<b>D0</b> No Dim	<b>11</b> □ White
				<b>40</b> 4000K		757 lm			<b>75</b> ■ Grey

## Notes:

\* For complete code ordering information, please see page 377.

\*\* For other CCT options, please contact us.

For related accessories, please see page 197.

# Dado



Dado  
Surface

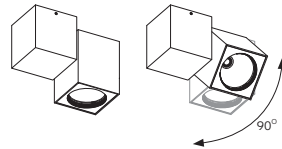
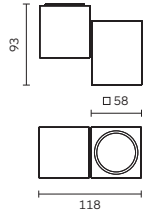

Code ordering example: 1158 BB22 - 90 30 14 D0 11

	Product Code	Light Source Code*	>CRI	CCT**	LED Power	Nominal Lumen	Beam Angle (BA°)	Driver Options	Finish
Dado	<b>1158</b>	<b>BB22</b>	<b>90</b>	<b>30</b> 3000K	6W	706 lm	<b>14 / 24 / 34</b>	<b>D0</b> No Dim	<b>11</b> □ White
Surface				<b>40</b> 4000K		757 lm			<b>75</b> ■ Grey

**Notes:**  
 \* For complete code ordering information, please see page 377.  
 \*\* For other CCT options, please contact us.  
 For related accessories, please see page 197.

# Rolo & Dado Surface Family configuration options

Code ordering example: 1158 BB22 - 90 30 14 D0 11

## Dado & Rolo Ceiling & Wall

Product Code	Light Source Code	>CRI	CCT	LED Power	Nominal Lumen	Beam Angle (BA°)	Driver Options	Finish
<b>1158</b> ○ Rolo	<b>BB22</b> Bridgelux COB	<b>90</b>	<b>30</b> 3000K	7W	706 lm	<b>14 / 24 / 34</b>	<b>D0</b> No Dim	<b>11</b> □ White
<b>1159</b> □ Dado	<b>BS12</b> Soraa SLC-16	<b>95</b>	<b>40</b> 4000K	8W	757 lm	<b>10</b>	<b>DA</b> Dali Dim	<b>75</b> ■ Grey
				12W	460 lm	<b>15 / 25 / 36</b>	<b>DC</b> CASAMBI	
					720 lm		<b>D1</b> 0-10V Dim	
					755lm			
<b>GU53</b> Retrofit	<b>MR16</b> -GU5.3	<b>00</b>	<b>00</b>	/	/	<b>00</b>	<b>DP</b> Phase Dim	
<b>GU10</b>	<b>GZ10</b> -GU10							

# Optical Accessories

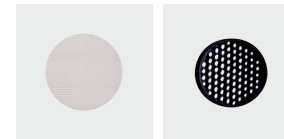

Product / Optical Accessories	Linear Spread Colour 41	Honeycomb Louvre Colour 10
Rolo & Dado Surface GU5.3	<b>2362</b>	<b>2361</b>

For Soraa specific accessories, please contact us and we will provide the detailed information.

**Notes:**  
 For other CCT options, please contact us.

# Conos Due

Surface 68 | 100 | 154



## Body

Wall/ceiling mounted luminaire with light body in cast aluminium and driver canopy in thermoplastic.

Reflector in super pure aluminium. Easy relamping via removable front housing by snap-in catch action Available in three sizes.

Tiltable vertically 0-100° and routable horizontally 350°.

## LED sources

Citizen CLU series.

CRI: 90, 95 | CCT: 3000K, 4000K.

Other CRI and CCT options available on request.

## Optic

Reflector.

Narrow, medium and wide beam angle available.

## Accessories

Honeycomb louvre.

## Finish

Powder coat in black, white or grey colour.

## Driver

Driver box inclusive of no-dimable driver.

Dimming Options: 0-10V Dim, DALI, Phase, CASAMBI.

## Applications

A crisp, compact design coupled with powerful capabilities. Provide a clean, unobtrusive look at the ceiling as it integrates well with virtually any interior while offering excellent aiming flexibility.

Application areas: retail, residential, restaurants, hotels.

## Related Products



# Conos Due



## Conos Due 68 / 100 / 154

Surface

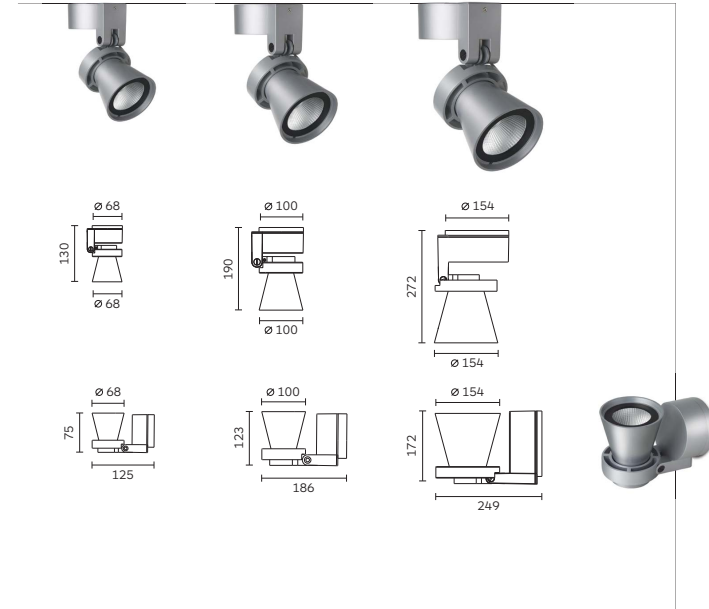

Code ordering example: **1 3 6 3 B C 2 2 - 9 0 3 0 1 6 D 0 1 0**

	Product Code	Light Source Code*	>CRI	CCT**	LED Power	Nominal Lumen	Beam Angle (BA°)	Driver Options	Finish
Conos Due 68	<b>1363</b>	<b>BC22</b>	<b>90</b>	<b>30</b> 3000K	7W	934 lm	<b>16 / 28 / 40</b>	<b>D0</b> No Dim	<b>10</b> ■ Black
Ceiling / Wall	<b>1364</b>			<b>40</b> 4000K		949 lm		<b>DP</b> Phase Dim	<b>11</b> □ White
Conos Due 100	<b>1361</b>				22W	2418 lm	<b>12 / 21 / 39</b>	<b>DA</b> Dali Dim	<b>75</b> ■ Grey
Ceiling / Wall	<b>1362</b>					2456 lm		<b>DC</b> CASAMBI	
Conos Due 154	<b>1198</b>	<b>BC21</b>			30W	3728 lm	<b>14 / 24 / 38</b>	<b>D1</b> 0-10V Dim	
Ceiling / Wall	<b>1206</b>					3785 lm			

## Notes:

\* For complete code ordering information, please see page 377.

\*\* For other CCT options, please contact us.

For related accessories, please see page 201.

## Conos Due Surface Family configuration options

Code ordering example: 1363 BC22 - 90 30 16 D0 10

### Conos Due 68

#### Ceiling & Wall

Product Code	Light Source Code	>CRI	CCT	LED Power	Nominal Lumen	Beam Angle (BA°)	Driver Options	Finish
<b>1363</b> Ceiling	<b>BC22</b> Citizen COB	<b>90</b>	<b>30</b> 3000K	7W	934 lm	<b>16 / 28 / 40</b>	<b>D0</b> No Dim	<b>10</b> ■ Black
<b>1364</b> Wall			<b>40</b> 4000K		949 lm		<b>DP</b> Phase Dim	<b>11</b> □ White
	<b>GU53</b> Retrofit MR16-GU5.3	<b>00</b>	<b>00</b>	/	/	<b>00</b>	<b>DP</b> Phase Dim	<b>75</b> ■ Grey
	<b>GU10</b> GZ10-GU10							

### Conos Due 100

#### Ceiling & Wall

Product Code	Light Source Code	>CRI	CCT	LED Power	Nominal Lumen	Beam Angle (BA°)	Driver Options	Finish
<b>1361</b> Ceiling	<b>BC22</b> Citizen COB	<b>90</b>	<b>30</b> 3000K	22W	2418 lm	<b>12 / 21 / 39</b>	<b>DP</b> Phase Dim	<b>10</b> ■ Black
<b>1362</b> Wall			<b>40</b> 4000K		2456 lm		<b>DC</b> CASAMBI	<b>11</b> □ White
							<b>D1</b> 0-10V Dim	<b>75</b> ■ Grey
	<b>GU53</b> Retrofit MR16-GU5.3	<b>00</b>	<b>00</b>	/	/	<b>00</b>	<b>DP</b> Phase Dim	
	<b>GU10</b> GZ10-GU10							

### Conos Due 154

#### Ceiling & Wall

Product Code	Light Source Code	>CRI	CCT	LED Power	Nominal Lumen	Beam Angle (BA°)	Driver Options	Finish
<b>1198</b> Ceiling	<b>BC21</b> Citizen COB	<b>90</b>	<b>30</b> 3000K	30W	3728 lm	<b>14 / 24 / 28</b>	<b>DP</b> Phase Dim	<b>10</b> ■ Black
<b>1206</b> Wall			<b>40</b> 4000K		3785 lm		<b>DC</b> CASAMBI	<b>11</b> □ White
							<b>D1</b> 0-10V Dim	<b>75</b> ■ Grey
	<b>AR11</b> Retrofit AR111-GU5.3	<b>00</b>	<b>00</b>	/	/	<b>00</b>	<b>DP</b> Phase Dim	

#### Notes:

For other CCT options, please contact us.

## Optical Accessories

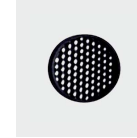

Product / Optical Accessories Honeycomb Louvre  
Colour 10

Conos Due 68 Surface **2B95**

Conos Due 100 Surface **2368**

Conos Due 154 Surface **2367**

# Miniluce

Surface 900 | 1200 | 1500



## Body

Surface mounted linear luminaire with luminaire body in extruded aluminium.

End caps in cast aluminium, diffuser made of satin opal acrylic.

Mountable horizontally or vertically according with the needs of the projects. Available in 3 different length.

## LED sources

Samsung SMD LED.  
CRI: 90 | CCT: 3000K, 4000K.  
Other CRI and CCT options, Tuneable White and DimToWarm versions available on request.

## Related Products

**Miniluce Pendant**  
P.236



## Accessories

No accessories available.

## Finish

Powder coat in black, white or grey colour.

## Driver

Inclusive of integrated no-dimable driver.  
Dimming Options: 0-10V Dim, DALI, CASAMBI.

## Applications

A simple and stylish design. The 3 directional emitting satin acrylic cover enables the architect and lighting designers the ability to integrate it into most applications including wet rooms. Application areas: office, schools, gyms, community buildings, supermarkets, retail.

# Miniluce



## Miniluce 900 / 1200 / 1500

Surface

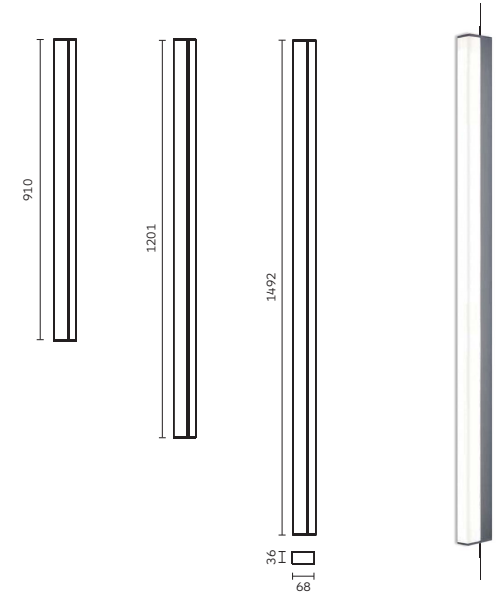

Code ordering example: **1 2 1 0 B M 1 1 - 9 0 3 0 0 0 D 0 7 5**

	Product Code	Light Source Code*	>CRI	CCT**	LED Power	Nominal Lumen	Beam Angle (BA°)	Driver Options	Finish
Miniluce 900 Surface	<b>1210</b>	<b>BM11</b> Samsung SMD	<b>90</b>	<b>30</b> 3000K	26W	2901 lm	EW ( <b>00</b> )	<b>D0</b> No Dim	<b>75</b> Grey
				<b>40</b> 4000K		3065 lm	<b>DA</b> Dali Dim		
Miniluce 1200 Surface	<b>1211</b>				35W	3868 lm		<b>DC</b> CASAMBI	
						4087 lm	<b>D1</b> 0-10V Dim		
Miniluce 1500 Surface	<b>1212</b>				44W	4835 lm			
						5109 lm			

## Notes:

\* For complete code ordering information, please see page 377.

\*\* For other CCT options, please contact us.

# Circo & Quadro

Surface 300 | 400 | 600



## Body

Ceiling/wall round or square mounted luminaire with light trim in aluminium, light body and diffuser in injection moulded polycarbonate.

Diffuser finished in satin opal inclusive of durable silicon gasket, easy to remove through snap-in catch action. Available in 3 sizes.

## LED sources

Samsung SMD LED.  
CRI: 90 | CCT: 3000K, 4000K.  
Other CRI and CCT options available on request.  
Emergency versions available upon request.

## Optic

Equipped with acrylic satin opal diffuser.

## Accessories

No accessories available.

## Finish

Powder coat in white colour.

## Driver

Inclusive of integrated no-dimable driver.  
Dimming Options: 0-10V Dim, DALI, Phase, CASAMBI.

## Applications

Architectural decorative luminaires designed to provide specification-grade quality at prices to fit the budgets for commercial and institutional interiors.  
Application areas: retail, hospitality, offices, schools and community buildings.

### Related Products

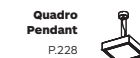
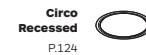

## Circo



**Circo 300 / 400 / 600**  
Surface

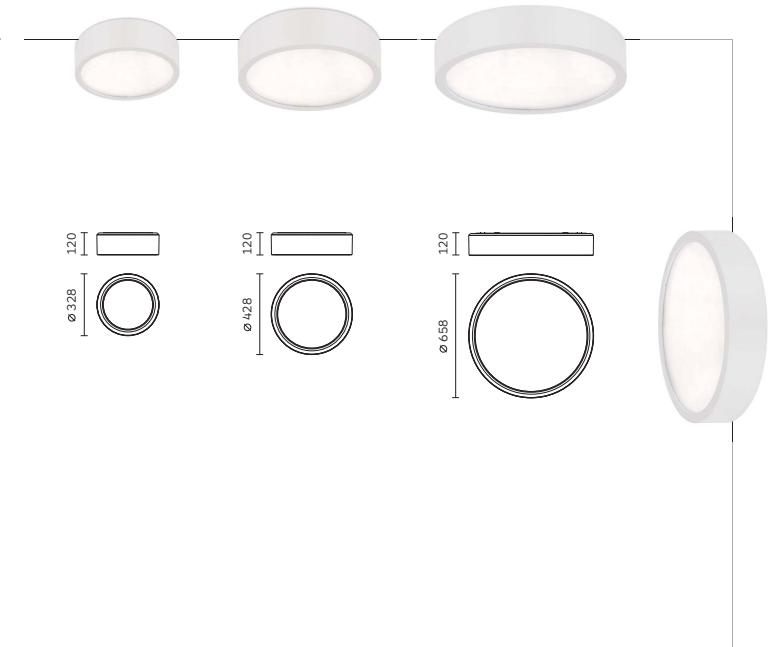

Code ordering example: **1 2 8 9 B M 1 1 - 9 0 3 0 0 0 D 0 1 1**

	Product Code	Light Source Code*	>CRI	CCT**	LED Power	Nominal Lumen	Beam Angle (BA°)	Driver Options	Finish
Circo 300 Surface	<b>1289</b>	<b>BM11</b>	<b>90</b>	<b>30</b> 3000K	30W	2652 lm	EW (00)	<b>D0</b> No Dim	<b>11</b> □ White
				<b>40</b> 4000K		2850 lm		<b>DA</b> Dali Dim	
Circo 400 Surface	<b>1286</b>				45W	3978 lm		<b>DP</b> Phase Dim	
						4275 lm		<b>DC</b> CASAMBI	
Circo 600 Surface	<b>1283</b>				80W	7072 lm		<b>D1</b> 0-10V Dim	
						7600 lm			

### Notes:

\* For complete code ordering information, please see page 377.

\*\* For other CCT options, please contact us.

EW = Extra Wide. Ordering code: **00**.

# Quadro



Quadro 300 / 400 / 600  
Surface

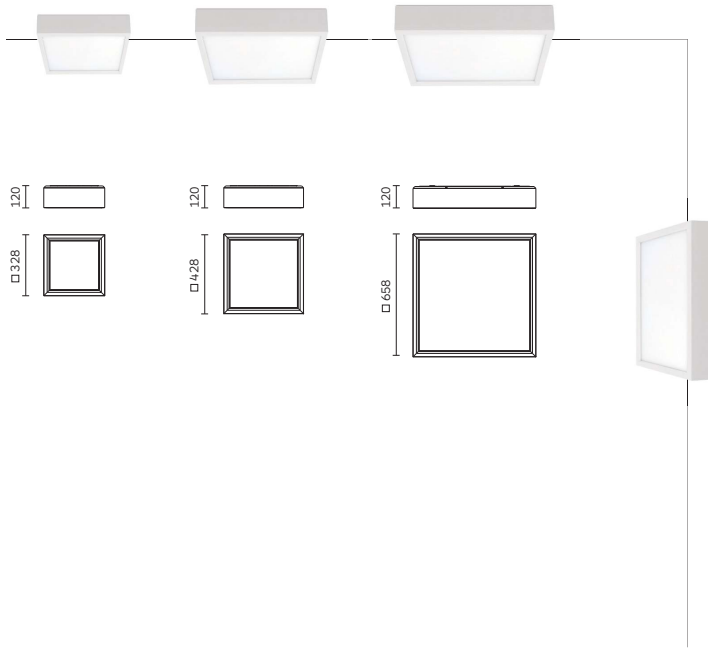

Code ordering example: 1280 BM11 - 90 3000 D0 11

	Product Code	Light Source Code*	>CRI	CCT**	LED Power	Nominal Lumen	Beam Angle (BA°)	Driver Options	Finish
Quadro 300 Surface	<b>1280</b>	<b>BM11</b>	<b>90</b>	<b>30</b> 3000K	30W	2652 lm	EW (00)	<b>D0</b> No Dim	<b>11</b> <input type="checkbox"/> White
				<b>40</b> 4000K		2850 lm		<b>DA</b> Dali Dim	
Quadro 400 Surface	<b>1276</b>				45W	3978 lm		<b>DP</b> Phase Dim	
						4275 lm		<b>DC</b> CASAMBI	
Quadro 600 Surface	<b>1273</b>				80W	7072 lm		<b>D1</b> 0-10V Dim	
						7600 lm			

**Notes:**  
 \* For complete code ordering information, please see page 377.  
 \*\* For other CCT options, please contact us.  
 EW = Extra Wide. Ordering code: **00**.

# Circo & Quadro Surface Family configuration options

Code ordering example: 1289 BM11 - 90 3000 D0 11

## Circo & Quadro 300

Ceiling & Wall

Product Code	Light Source Code	>CRI	CCT	LED Power	Nominal Lumen	Beam Angle (BA°)	Driver Options	Finish
<b>1289</b> Circo	<b>BM11</b> Samsung SMD	<b>90</b>	<b>30</b> 3000K	30W	2652 lm	EW (00)	<b>D0</b> No Dim	<b>11</b> <input type="checkbox"/> White
<b>1280</b> Quadro			<b>40</b> 4000K		2850 lm		<b>DA</b> Dali Dim <b>DP</b> Phase Dim <b>DC</b> CASAMBI <b>D1</b> 0-10V Dim	

## Circo & Quadro 400

Ceiling & Wall

Product Code	Light Source Code	>CRI	CCT	LED Power	Nominal Lumen	Beam Angle (BA°)	Driver Options	Finish
<b>1286</b> Circo	<b>BM11</b> Samsung SMD	<b>90</b>	<b>30</b> 3000K	45W	3978 lm	EW (00)	<b>D0</b> No Dim	<b>11</b> <input type="checkbox"/> White
<b>1276</b> Quadro			<b>40</b> 4000K		4275 lm		<b>DA</b> Dali Dim <b>DP</b> Phase Dim <b>DC</b> CASAMBI <b>D1</b> 0-10V Dim	

## Circo & Quadro 600

Ceiling & Wall

Product Code	Light Source Code	>CRI	CCT	LED Power	Nominal Lumen	Beam Angle (BA°)	Driver Options	Finish
<b>1283</b> Circo	<b>BM11</b> Samsung SMD	<b>90</b>	<b>30</b> 3000K	80W	7072 lm	EW (00)	<b>D0</b> No Dim	<b>11</b> <input type="checkbox"/> White
<b>1273</b> Quadro			<b>40</b> 4000K		7600 lm		<b>DA</b> Dali Dim <b>DP</b> Phase Dim <b>DC</b> CASAMBI <b>D1</b> 0-10V Dim	

**Notes:**  
 For other CCT options, please contact us.



# Nano

## Surface



## Body

Wall round or square mounted luminaire with front trim in cast Back housing is made of injection moulded translucent plastic, diffuser cover made in satin acrylic.

Easy relamping via removable front frame by twist and lock action.

## LED sources

Edison SMD LED.  
CRI: 90 | CCT: 3000K, 4000K.  
Other CRI and CCT options available on request.

## Optic

Equipped with acrylic satin opal diffuser.

## Accessories

Back Plate available in different colours.

## Finish

Powder coat in white or grey colour.

## Driver

Inclusive of integrated no-dimable driver.

## Applications

Its miniature design makes it easy and versatile to apply and install. It has optional back translucent bezels in various colours for halo back lighting effect.  
Application areas: hotels, residential, lift lobbies, corridors, retail.

## Related Products

Orbit  
Wall  
P.344



# Nano Round & Square



## Nano

Surface Round & Square

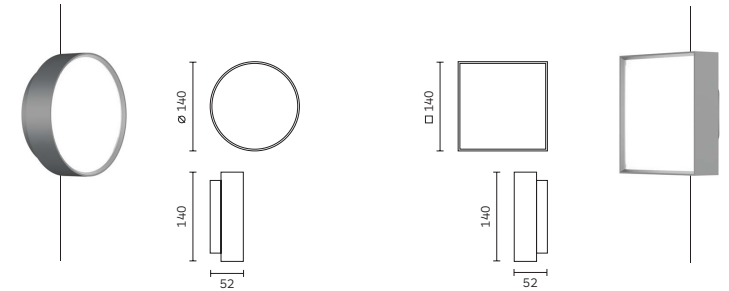

Code ordering example: **1 2 4 8 M E 1 1 - 9 0 3 0 0 0 D 0 1 0**

	Product Code	Light Source Code*	>CRI	CCT**	LED Power	Nominal Lumen	Beam Angle (BA°)	Driver Options	Finish
Nano Round	<b>1248</b>	<b>ME11</b> Edison SMD	<b>90</b>	<b>30</b> 3000K	3.3W	372 lm	EW (00)	<b>D0</b> No Dim	<b>10</b> ■ Black
Nano Square	<b>1249</b>		<b>40</b>	4000K		439 lm			<b>11</b> □ White <b>75</b> ■ Grey

## Optical Accessories

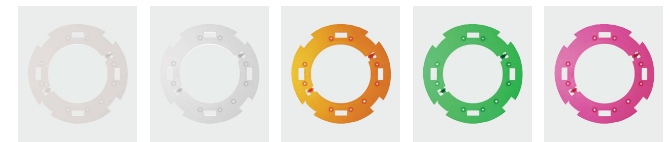

Product / Optical Accessories	Back Plate Colour 18	Back Plate Colour 41	Back Plate Colour 46	Back Plate Colour 85	Back Plate Colour 94
Nano Back Plate-Round	<b>2268</b>	<b>2268</b>	<b>2268</b>	<b>2268</b>	<b>2268</b>
Nano Back Plate-Square	<b>2280</b>	<b>2280</b>	<b>2280</b>	<b>2280</b>	<b>2280</b>

## Notes:

\* For complete code ordering information, please see page 377.

\*\* For other CCT options, please contact us.

EW = Extra Wide. Ordering code: **00**.

# Cubetto

## Surface



## Body

Wall square mounted luminaire with body in cast aluminium inclusive of slots with opal light diffuser.

Easy G9 light source relamping via removable front lamp housing by snap-in catch action.

Available in five different light distribution versions.

## LED sources

Nichia single LED.  
CRI: 90 | CCT: 3000K, 4000K.  
Other CRI and CCT options available on request.

## Related Products



## Accessories

No accessories available.

## Finish

Powder coat in white or grey colour.

## Optic

The slots of the different version offer a wide range of beam angles.

## Driver

Inclusive of integrated no-dimable driver.

## Applications

A simple modernistic fixture ideal for today's architectural developments. With its Up/Down version it gives that special narrow beam light effect for a personalized application. Application areas: facades, lobbies, walkways, corridors, restaurants, hotels.

# Cubetto



## Cubetto S1/S2/SG/G1/G2

Surface

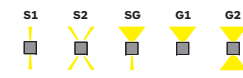
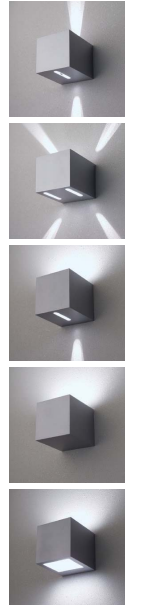
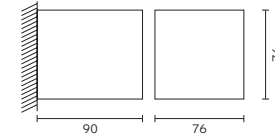

Code ordering example: 1164 MN11 - 90 30 00 D0 11

	Product Code	Light Source Code*	>CRI	CCT**	LED Power	Nominal Lumen	Beam Angle (BA°)	Driver Options	Finish
Cubetto S1	<b>1164</b>	<b>MN11</b> Nichia Single LED	<b>90</b>	<b>30</b> 3000K	1W	109 lm	<b>00</b>	<b>D0</b> No Dim	<b>11</b> □ White
Cubetto S2	<b>1165</b>			<b>40</b> 4000K		116 lm			<b>75</b> ■ Grey
Cubetto SG	<b>1166</b>								
Cubetto G1	<b>1167</b>								
Cubetto G2	<b>1168</b>								

## Notes:

\* For complete code ordering information, please see page 377.

\*\* For other CCT options, please contact us.

# DomoLED

Surface Round & Square 95 | 180 | 235



## Body

Round or square ceiling mounted luminaire with light trim in cast aluminium inclusive of diffuser made of satin opal acrylic.

Light body in extruded aluminium. Easy installation via twist and lock action using PC injection moulded gear.

Front trim/diffuser removable by snap-in catch action. Available in 3 different sizes.

## Accessories

No accessories available.

## Finish

Powder coat in black, white or grey colour.

## LED sources

Samsung SMD LED.  
CRI: 90 | CCT: 3000K, 4000K.  
Other CRI and CCT options available on request.

## Optic

Equipped with acrylic satin opal diffuser.

## Driver

Inclusive of integrated no-dimable driver.  
Dimming Options: 0-10V Dim, DALI, Phase, CASAMBI.

## Applications

A simple and stylish design. The 3 directional emitting satin acrylic cover enables the architect and lighting designers the ability to integrate it into most applications including wet rooms.  
Application areas: office, schools, gyms, community buildings, supermarkets, retail.

### Related Products

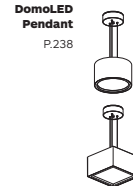
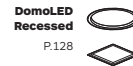

# DomoLED Round



**DomoLED 95 / 180 / 235**  
Surface Round

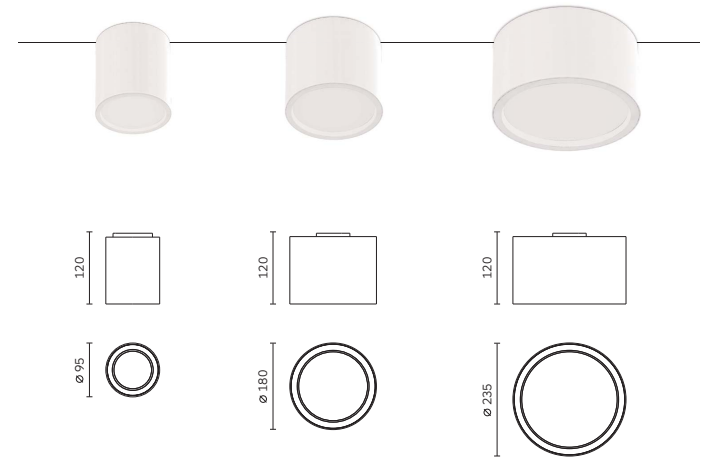

Code ordering example: **1 2 3 3 B M 1 1 - 9 0 3 0 0 0 D 0 1 0**

	Product Code	Light Source Code*	>CRI	CCT**	LED Power	Nominal Lumen	Beam Angle (BA°)	Driver Options	Finish
DomoLED 95 Surface Round	<b>1233</b>	<b>BM11</b>	<b>90</b>	<b>30</b> 3000K <b>40</b> 4000K	8W	928 lm 976 lm	EW ( <b>00</b> )	<b>D0</b> No Dim <b>DP</b> Phase Dim <b>D1</b> 0-10V Dim	<b>10</b> ■ Black <b>11</b> □ White <b>75</b> ■ Grey
DomoLED 180 Surface Round	<b>1232</b>				22W	2552 lm 2684 lm		<b>D0</b> No Dim <b>DA</b> Dali Dim	
DomoLED 235 Surface Round	<b>1231</b>				34W	3944 lm 4148 lm		<b>DP</b> Phase Dim <b>DC</b> CASAMBI <b>D1</b> 0-10V Dim	

### Notes:

\* For complete code ordering information, please see page 377.

\*\* For other CCT options, please contact us.

EW = Extra Wide. Ordering code: **00**.

## DomoLED Square



DomoLED 95 / 180 / 235  
Surface Square

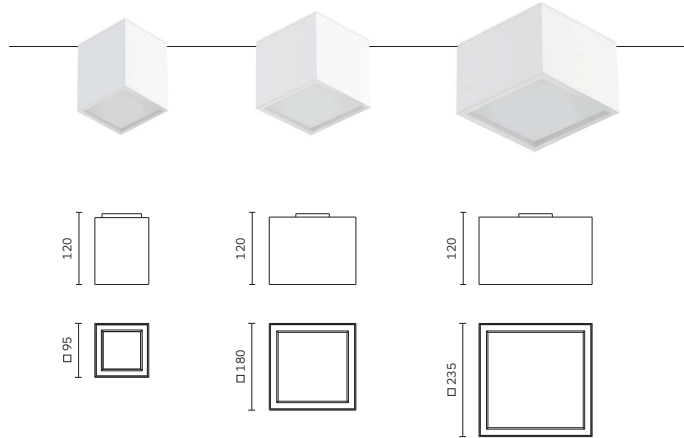

Code ordering example: 1236 BM11 - 90 30 00 D0 10

	Product Code	Light Source Code*	>CRI	CCT**	LED Power	Nominal Lumen	Beam Angle (BA°)	Driver Options	Finish
DomoLED 95	<b>1236</b>	<b>BM11</b>	<b>90</b>	<b>30</b> 3000K	8W	928 lm	EW ( <b>00</b> )	<b>D0</b> No Dim	<b>10</b> ■ Black
Surface Square			<b>40</b>	4000K		976 lm		<b>DP</b> Phase Dim <b>D1</b> 0-10V Dim	<b>11</b> □ White <b>75</b> ■ Grey
DomoLED 180	<b>1235</b>				22W	2552 lm		<b>D0</b> No Dim	
Surface Square						2684 lm		<b>DA</b> Dali Dim	
DomoLED 235	<b>1234</b>				34W	3944 lm		<b>DP</b> Phase Dim	
Surface Square						4148 lm		<b>DC</b> CASAMBI <b>D1</b> 0-10V Dim	

### Notes:

\* For complete code ordering information, please see page 377.  
\*\* For other CCT options, please contact us.  
EW = Extra Wide. Ordering code: **00**.

## DomoLED Ceiling Family configuration options

Code ordering example: 1233 BM11 - 90 30 00 D0 10

### DomoLED 95 Ceiling

Product Code	Light Source Code	>CRI	CCT	LED Power	Nominal Lumen	Beam Angle (BA°)	Driver Options	Finish
<b>1233</b> Round	<b>BM11</b> Samsung SMD	<b>90</b>	<b>30</b> 3000K	8W	928 lm	EW ( <b>00</b> )	<b>D0</b> No Dim	<b>10</b> ■ Black
<b>1236</b> Square			<b>40</b> 4000K		976 lm		<b>DP</b> Phase Dim <b>D1</b> 0-10V Dim	<b>11</b> □ White <b>75</b> ■ Grey

### DomoLED 180 Ceiling

Product Code	Light Source Code	>CRI	CCT	LED Power	Nominal Lumen	Beam Angle (BA°)	Driver Options	Finish
<b>1232</b> Round	<b>BM11</b> Samsung SMD	<b>90</b>	<b>30</b> 3000K	22W	2252 lm	EW ( <b>00</b> )	<b>D0</b> No Dim	<b>10</b> ■ Black
<b>1235</b> Square			<b>40</b> 4000K		2684 lm		<b>DA</b> Dali Dim <b>DP</b> Phase Dim <b>DC</b> CASAMBI <b>D1</b> 0-10V Dim	<b>11</b> □ White <b>75</b> ■ Grey

### DomoLED 235 Ceiling

Product Code	Light Source Code	>CRI	CCT	LED Power	Nominal Lumen	Beam Angle (BA°)	Driver Options	Finish
<b>1231</b> Round	<b>BM11</b> Samsung SMD	<b>90</b>	<b>30</b> 3000K	34W	3944 lm	EW ( <b>00</b> )	<b>D0</b> No Dim	<b>10</b> ■ Black
<b>1234</b> Square			<b>40</b> 4000K		4148 lm		<b>DA</b> Dali Dim <b>DP</b> Phase Dim <b>DC</b> CASAMBI <b>D1</b> 0-10V Dim	<b>11</b> □ White <b>75</b> ■ Grey

### Notes:

For other CCT options, please contact us.

# Pixo

Pendant 36 | 77



## Body

Pendant mounted luminaire with light body in extruded aluminium.

Light body available in two diameter (36mm and 77mm)  
Exchangable front ring in wide range of colours.

Supplied with ceiling canopy and pre-installed 1.5m electrical cable and with 1 x 1.5m pendant steel wires. Available in two sizes and four different length.

## LED sources

Bridgelux V or Vero series.  
CRI: 90 | CCT: 3000K, 4000K, TuneableWhite.  
Other CRI and CCT options available on request.

## Optic

Reflector.  
Narrow, medium and wide beam angle available.

## Accessories

Decorative ring available in different colours. Transparent acrylic decorative diffuser.

## Finish

Powder coat in black or white.  
Exchangable front ring in different colours.

## Driver

Supplied with integrated no-dimable driver.  
Dimming Options: 0-10V Dim, Phase, CASAMBI, available for Pixo 77.

## Applications

A modern designed pendant ambient light. Its accessories make it the perfect match for sophisticated environments. Application areas: residential, hotels, restaurants, retail, corridors.

### Related Products



# Pixo

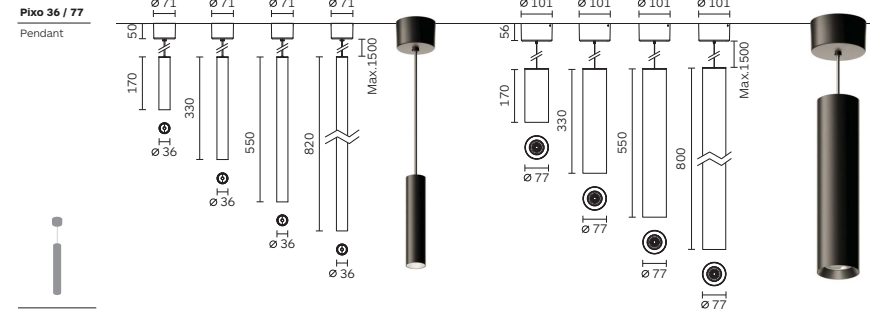

Code ordering example: **7 2 3 5 B B 2 2 - 9 0 3 0 2 0 D 0 1 0**

	Product Code	Product Length	Light Source Code*	>CRI	CCT**	LED Power	Nominal Lumen	Beam Angle (BA°)	Driver Options	Finish
Pixo 36 Pendant	<b>7235</b>	170	<b>BB22</b> Bridgelux COB	<b>90</b>	<b>30</b> 3000K	6W	730 lm	<b>20 / 44</b>	<b>D0</b> No Dim	<b>10</b> ■ Black
	<b>7236</b>	330			<b>40</b> 4000K		782 lm		<b>DP</b> Phase Dim	<b>11</b> □ White
	<b>7238</b>	550							<b>DC</b> CASAMBI	
	<b>7240</b>	820							<b>D1</b> 0-10V Dim	
Pixo 77 Pendant	<b>7234</b>	170	<b>BB12</b>			11W	1364 lm	<b>16 / 30</b>		
	<b>7237</b>	330					1460 lm			
	<b>7239</b>	550								
	<b>7241</b>	800								

## Optical Accessories

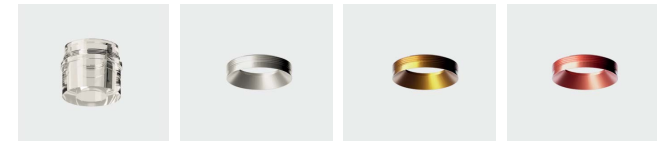

Product / Optical Accessories	Acrylic diffuser	Colour Ring Colour 33	Colour Ring Colour 35	Colour Ring Colour 55
Pixo 36	<b>2C36</b>	<b>2C34</b>	<b>2C34</b>	<b>2C34</b>
Pixo 77	<b>2C35</b>	<b>2C33</b>	<b>2C33</b>	<b>2C33</b>

### Notes:

\* For complete code ordering information, please see page 377.

\*\* For other CCT options, please contact us.

For Pixo 36 available only No Dim option (**D0**).

# Polaris

Pendant 30



## Body

Pendant mounted luminaire with light body in extruded aluminium inclusive of integrated diamond faceted no-dazzle louvre in thermoplastic.

Light body measuring 45mm in width and 65mm in height.

Supplied with ceiling canopy and pre-installed 1.5m electrical cable and with 2 x 1.5m pendant steel wires. Available in two different lengths.

## Accessories

No accessories available.

## Finish

Light body powder coat in black or white finish. Integrated louvre available in black or white finish.

## LED sources

Osram Oslon Square high power led  
CRI: 90 | CCT: 3000K, 4000K, TuneableWhite.  
Other CRI and CCT options available on request.

## Optic

Reflector. Medium and wide beam angle available.  
UGR<13 for a better visual comfort.

## Driver

Inclusive of integrated no-dimable driver.  
Dimming Options: 0-10V Dim, DALI, Phase, CASAMBI.

## Applications

An innovative solution for high brilliance and performance. The light source is barely visible, as the miniature light heads create a high contrast and circular light emission.  
Application areas: residential, hotels, restaurants, retail, corridors.

### Related Products



# Polaris



**Polaris 30**  
Pendant 36 / 48

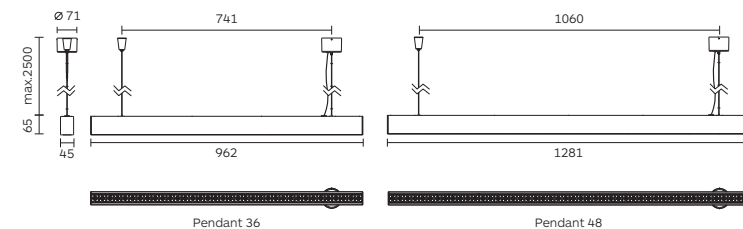

Code ordering example: **7 2 0 5 B O 1 1 - 9 0 3 0 3 4 D 0 1 0**

	Product Code	Light Source Code*	>CRI	CCT**	LED Power	Nominal Lumen	Beam Angle (BA°)	Driver Options	Finish
Polaris 30	<b>7205</b>	<b>BO11</b> Osram 3030	<b>90</b>	<b>30</b> 3000K	36x2W	6840 lm	<b>34 / 50</b>	<b>D0</b> No Dim	<b>10</b> ■ Black
Pendant 36				<b>40</b> 4000K		8640 lm		<b>DA</b> Dali Dim	<b>11</b> □ White
Polaris 30	<b>7211</b>				48x2W	9120 lm		<b>DC</b> CASAMBI	<b>17</b> ▨ B/W
Pendant 48						11520 lm		<b>D1</b> 0-10V Dim	

### Notes:

- \* For complete code ordering information, please see page 377.
- \*\* For other CCT options, please contact us.

# Zero

Pendant 66 | 100 | 130



## Body

Pendant mounted spotlight with light body and mounting clamps in cast aluminium.

Supplied with ceiling canopy and pre-installed 1.5m electrical cable with 2 x 1.5m pendant steel wires. Top cover options of different coloured finishes. Available in 3 different sizes.

Versatile aiming angle tiltable vertically 0°-90° in two directions and rotatable horizontally 360°.

## LED sources

Citizen CLU Series. Xicato Artist, Beauty and Designer Series. SORAA SLC Optical Light Engine.  
CRI: 90, 95, 98 | CCT: 2700K, 3000K, 4000K.  
Other CRI and CCT options, Tuneable White and DimToWarm versions available on request.

## Optic

Reflector.  
Narrow, medium and wide beam angle available.

## Accessories

Coloured filters, linear spread, honeycomb louvre, visor, snoot. Snap System™ accessories available for SORAA SLC series with narrow beam angle.

## Finish

Powder coat in black and white colour.

## Driver

Inclusive of integrated no-dimable driver.  
Dimming Options: 0-10V Dim, DALI, Phase, CASAMBI.

## Applications

A pendant luminaire featuring a clean aesthetic, ideal also for high ceiling spaces and for local 'task' lighting when placed over counters and tables. Application areas: restaurants, hotels, lobbies, residential, retail.

### Related Products

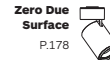
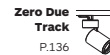

# Zero



**Zero 66 / 100 / 130**

Pendant

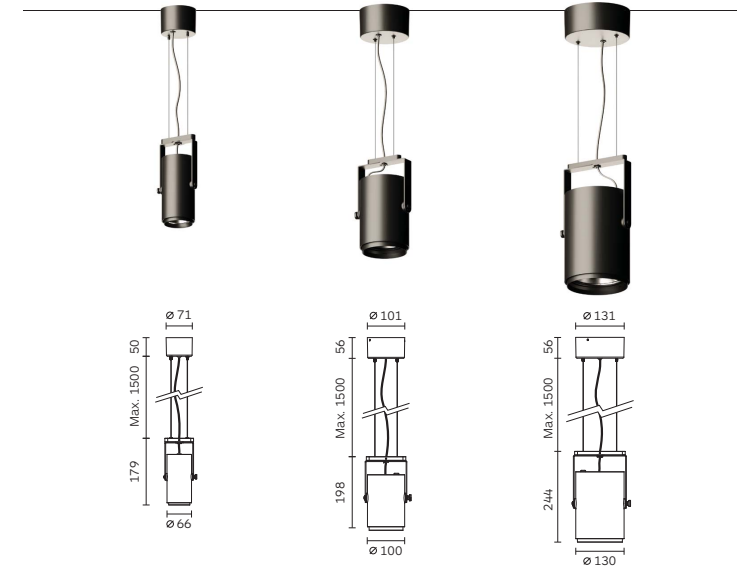

Code ordering example: **7 1 8 9 B C 3 2 - 9 0 3 0 1 5 D 0 1 0**

	Product Code	Light Source Code*	>CRI	CCT**	LED Power	Nominal Lumen	Beam Angle (BA°)	Driver Options	Finish
Zero 66 Pendant	<b>7189</b>	<b>BC32</b>	<b>90</b>	<b>30</b> 3000K	12W	1357 lm	<b>15 / 23 / 45</b>	<b>D0</b> No Dim	<b>10</b> ■ Black
				<b>40</b> 4000K		1414 lm		<b>DP</b> Phase Dim	<b>11</b> □ White
Zero 100 Pendant	<b>7188</b>	<b>BC33</b>			33W	3114 lm	<b>12 / 27 / 55</b>	<b>D0</b> No Dim	
						3245 lm		<b>DA</b> Dali Dim	
Zero 130 Pendant	<b>7168</b>	<b>BC34</b>			45W	3978 lm	<b>10 / 18 / 42</b>	<b>DP</b> Phase Dim	
						4144 lm		<b>DC</b> CASAMBI	
								<b>D1</b> 0-10V Dim	

### Notes:

\* For complete code ordering information, please see page 377.

\*\* For other CCT options, please contact us.

For related accessories, please see page 223.

## Zero Family configuration options

Code ordering example: 7 1 8 9 B C 3 2 - 9 0 3 0 1 5 D 0 1 0

### Zero 66

#### Pendant

Product Code	Light Source Code			>CRI	CCT	LED Power	Nominal Lumen	Beam Angle (BA°)	Driver Options	Finish	
<b>7189</b>	<b>BC32</b>	Citizen	COB	<b>90</b>	<b>30</b>	3000K	12W	1357 lm	<b>D0</b> No Dim	<b>10</b> ■ Black	
					<b>40</b>	4000K		1414 lm			
	<b>BX25</b>	Xicato	Artist	XTM	<b>98</b>	<b>27</b>	2700K	20W	1700 lm	<b>30 / 42 / 55</b>	<b>DP</b> Phase Dim
	<b>BX32</b>		Beauty	XTM	<b>95</b>			2000 lm	<b>28 / 35 / 45</b>	<b>DC</b> CASAMBI	
<b>BX42</b>		Designer	XTM	<b>90</b>			17.1W		<b>D1</b> 0-10V Dim		

### Zero 100

#### Pendant

Product Code	Light Source Code			>CRI	CCT	LED Power	Nominal Lumen	Beam Angle (BA°)	Driver Options	Finish	
<b>7188</b>	<b>BC33</b>	Citizen	COB	<b>90</b>	<b>30</b>	3000K	33W	3114 lm	<b>D0</b> No Dim	<b>10</b> ■ Black	
					<b>40</b>	4000K		3245 lm			
	<b>BX26</b>	Xicato	Artist	XTM	<b>98</b>	<b>27</b>	2700K	30.5W	2140 lm	<b>20 / 40 / 60</b>	<b>DP</b> Phase Dim
	<b>BX43</b>		Designer	XTM	<b>90</b>			25.7W		<b>DC</b> CASAMBI	
									<b>D1</b> 0-10V Dim		

### Zero 130

#### Pendant

Product Code	Light Source Code			>CRI	CCT	LED Power	Nominal Lumen	Beam Angle (BA°)	Driver Options	Finish	
<b>7168</b>	<b>BC34</b>	Citizen	COB	<b>90</b>	<b>30</b>	3000K	45W	3978 lm	<b>D0</b> No Dim	<b>10</b> ■ Black	
					<b>40</b>	4000K		4144 lm			
	<b>BX18</b>	Xicato	Standard	XTM	<b>83</b>	<b>27</b>	2700K	30.5W	3850 lm	<b>20 / 40 / 60</b>	<b>DP</b> Phase Dim
	<b>BX44</b>		Designer	XTM	<b>90</b>			41.8W	4500 lm	<b>DC</b> CASAMBI	
									<b>D1</b> 0-10V Dim		

#### Notes:

For other CCT options, please contact us.

## Optical Accessories

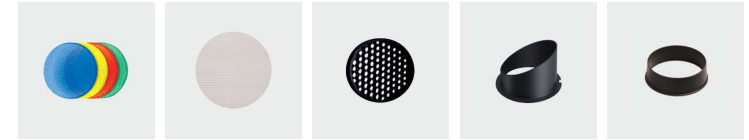

Product / Optical Accessories	Coloured Filters Colours 25, 42, 55, 85	Linear Spread Colour 41	Honeycomb Louvre Colour 10	Visor Colours 10, 17	Snoot Colours 10, 17
Zero 66 Pendant	<b>2A48*</b>	<b>2A51</b>	<b>2A54</b>	<b>2A60</b>	<b>2A65</b>
Zero 100 Pendant	<b>2A47*</b>	<b>2A50</b>	<b>2A53</b>	<b>2A64</b>	<b>2A59</b>
Zero 130 Pendant	<b>2A46*</b>	<b>2A49</b>	<b>2A52</b>	<b>2A63</b>	<b>2A58</b>

\* With holder



# Palla

Pendant 70 | 100 | 130



## Body

Pendant mounted spotlight with light body and driver canopy in cast aluminium.

Supplied with ceiling canopy and pre-installed 1.5m electrical cable with 1.5m pendant steel wires.

Dome available in different coloured finishes (blue, yellow, green, red). Available in 3 different sizes.

## LED sources

Citizen CLU Series. Xicato Artist, Beauty and Designer Series. SORAA SLC Optical Light Engine.  
CRI: 90, 95, 98 | CCT: 2700K, 3000K, 4000K.  
Other CRI and CCT options, Tuneable White and DimToWarm versions available on request.

## Optic

Lens.  
Narrow, medium and wide beam angle available.

## Accessories

Honeycomb louvre. Snap System™ accessories available for SORAA SLC series with narrow beam angle.

## Finish

Powder coat in black and white colour.

## Driver

Driver canopy inclusive of no-dimable driver. Dimming Options: 0-10V Dim, DALI, Phase, CASAMBI.  
The shape of the box may change according with the chosen dimming options.

## Applications

A pendant luminaire featuring a clean aesthetic, ideal also for high ceiling spaces and for local 'task' lighting when placed over counters and tables.  
Application areas: restaurants, hotels, residential, retail.

## Related Products



# Palla



**Palla 70 / 100 / 130**  
Pendant

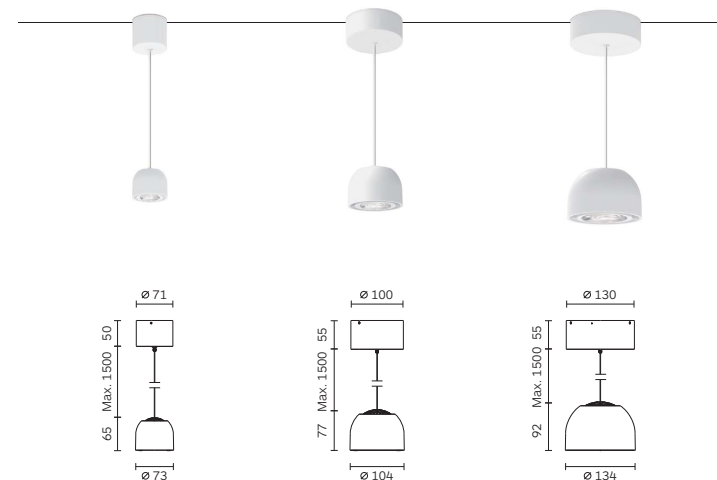

Code ordering example: **7 2 3 1 B C 2 2 - 9 0 3 0 1 6 D 0 1 0**

	Product Code	Light Source Code*	>CRI	CCT**	LED Power	Nominal Lumen	Beam Angle (BA°)	Driver Options	Finish
Palla 70 Pendant	<b>7231</b>	<b>BC22</b>	<b>90</b>	<b>30</b> 3000K	12W	1500 lm	<b>16 / 25 / 36</b>	<b>D0</b> No Dim	<b>10</b> ■ Black
				<b>40</b> 4000K		1550 lm		<b>DA</b> Dali Dim	<b>11</b> □ White
Palla 100 Pendant	<b>7232</b>	<b>BC33</b>			21W	2200 lm	<b>15 / 24 / 38</b>	<b>DP</b> Phase Dim	
						2300 lm		<b>DC</b> CASAMBI	
Palla 130 Pendant	<b>7233</b>	<b>BC33</b>			33W	3220 lm	<b>12 / 22 / 32</b>	<b>D1</b> 0-10V Dim	
						3300 lm			

## Notes:

\* For complete code ordering information, please see page 377.

\*\* For other CCT options, please contact us.

For related accessories, please see page 227.

## Palla Family configuration options

Code ordering example: 7 2 3 1 B C 2 2 - 9 0 3 0 1 6 D 0 1 0

### Palla 70

#### Pendant

Product Code	Light Source Code	>CRI	CCT	LED Power	Nominal Lumen	Beam Angle (BA°)	Driver Options	Finish
<b>7231</b>	<b>BC22</b> Citizen COB	<b>90</b>	<b>30</b> 3000K	12W	1500 lm	<b>16 / 25 / 36</b>	<b>D0</b> No Dim	<b>10</b> ■ Black
			<b>40</b> 4000K		1550 lm		<b>DA</b> Dali Dim	<b>11</b> □ White
	<b>MS12</b> Soraa SLC-16	<b>95</b>		10W	500 lm	<b>10 / 25 / 36</b>	<b>DP</b> Phase Dim	
					525 lm		<b>DC</b> CASAMBI	
							<b>D1</b> 0-10V Dim	

### Palla 100

#### Pendant

Product Code	Light Source Code	>CRI	CCT	LED Power	Nominal Lumen	Beam Angle (BA°)	Driver Options	Finish
<b>7232</b>	<b>BC33</b> Citizen COB	<b>90</b>	<b>30</b> 3000K	21W	2200 lm	<b>15 / 24 / 38</b>	<b>D0</b> No Dim	<b>10</b> ■ Black
			<b>40</b> 4000K		2300 lm		<b>DA</b> Dali Dim	<b>11</b> □ White
	<b>BS12</b> Soraa SLC-16	<b>95</b>		14W	800 lm	<b>10 / 25 / 36</b>	<b>DP</b> Phase Dim	
					850 lm		<b>DC</b> CASAMBI	
	<b>BX25</b> Xicato Artist XTM	<b>98</b>	<b>27</b> 2700K	13W	1400 lm	<b>16 / 28 / 38</b>	<b>D1</b> 0-10V Dim	
	<b>BX31</b> Beauty XTM	<b>95</b>		9.5W	931 lm	<b>28 / 35 / 45</b>		
	<b>BX41</b> Designer XTM	<b>90</b>		11.4W	1300 lm			

### Palla 130

#### Pendant

Product Code	Light Source Code	>CRI	CCT	LED Power	Nominal Lumen	Beam Angle (BA°)	Driver Options	Finish
<b>7233</b>	<b>BC33</b> Citizen COB	<b>90</b>	<b>30</b> 3000K	33W	3220 lm	<b>12 / 22 / 32</b>	<b>D0</b> No Dim	<b>10</b> ■ Black
			<b>40</b> 4000K		3300 lm		<b>DA</b> Dali Dim	<b>11</b> □ White
	<b>BS22</b> Soraa SLC-30	<b>95</b>		20W	1200 lm	<b>09 / 25 / 36</b>	<b>DP</b> Phase Dim	
					1300 lm		<b>DC</b> CASAMBI	
	<b>BX25</b> Xicato Artist XTM	<b>98</b>	<b>27</b> 2700K	20W	2000 lm	<b>25 / 36 / 45</b>	<b>D1</b> 0-10V Dim	
	<b>BX32</b> Beauty XTM	<b>95</b>						
	<b>BX43</b> Designer XTM	<b>90</b>		25.7W	3000 lm			

#### Notes:

For other CCT options, please contact us.

## Optical Accessories

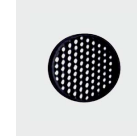

Product / Optical Accessories	Honeycomb Louvre Colour 10
Palla 70 Pendant	<b>2B95</b>
Palla 100 Pendant	<b>2B99</b>
Palla 130 Pendant	<b>2C04</b>

For SORAA specific accessories, please contact us and we will provide the detailed information.

# Circo & Quadro

Pendant Round & Square 300 | 400 | 630



## Body

Pendant mounted round or square luminaire with light trim and driver canopy in aluminium.

Light body in injection moulded polycarbonate. Satin opal diffuser, inclusive of durable silicon gasket, easy removable trough snap-in catch action.

Supplied with ceiling canopy and pre-installed 1.5m electrical cable with 1.5m pendant steel wires. Available in 3 different sizes.

## Accessories

No accessories available.

## Finish

Powder coat in black and white colour.

## LED sources

Samsung SMD LED.  
CRI: 90 | CCT: 3000K, 4000K.  
Other CRI and CCT options available on request.

## Optic

Equipped with acrylic satin opal diffuser.

## Driver

Inclusive of integrated no-dimable driver.  
Dimming Options: 0-10V Dim, DALI, Phase, CASAMBI.

## Applications

Architectural decorative luminaires program designed to provide specification-grade quality at prices to fit the budgets for commercial and institutional interiors.  
Application areas: retail, hospitality, offices, schools, community buildings.

## Related Products

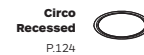

## Circo



### Circo 300 / 400 / 600

Pendant

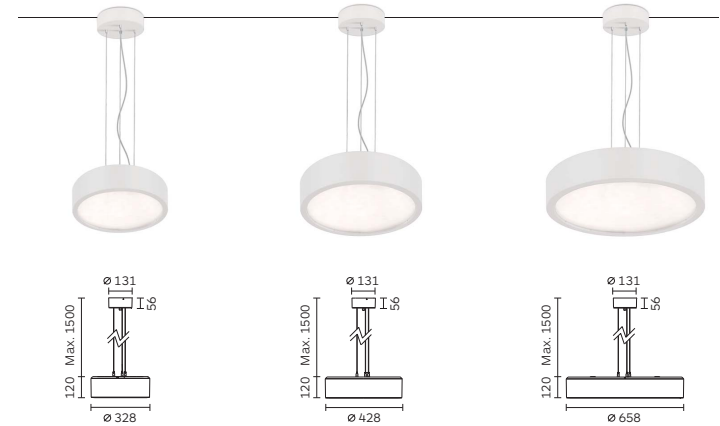

Code ordering example: **7 1 5 9 B M 1 1 - 9 0 3 0 0 0 D 0 1 1**

	Product Code	Light Source Code*	>CRI	CCT**	LED Power	Nominal Lumen	Beam Angle (BA°)	Driver Options	Finish
Circo 300 Pendant	<b>7159</b>	<b>BM11</b> Samsung SMD	<b>90</b>	<b>30</b> 3000K	30W	1326 lm	EW ( <b>00</b> )	<b>D0</b> No Dim	<b>11</b> White
				<b>40</b> 4000K		1425 lm		<b>DA</b> Dali Dim	
Circo 400 Pendant	<b>7156</b>				45W	3978 lm		<b>DP</b> Phase Dim	
						4275 lm		<b>DC</b> CASAMBI	
Circo 600 Pendant	<b>7153</b>				80W	7072 lm		<b>D1</b> 0-10V Dim	
						7600 lm			

### Notes:

\* For complete code ordering information, please see page 377.

\*\* For other CCT options, please contact us.

EW = Extra Wide. Ordering code: **00**.

# Quadro



## Quadro 300 / 400 / 600

Pendant Square

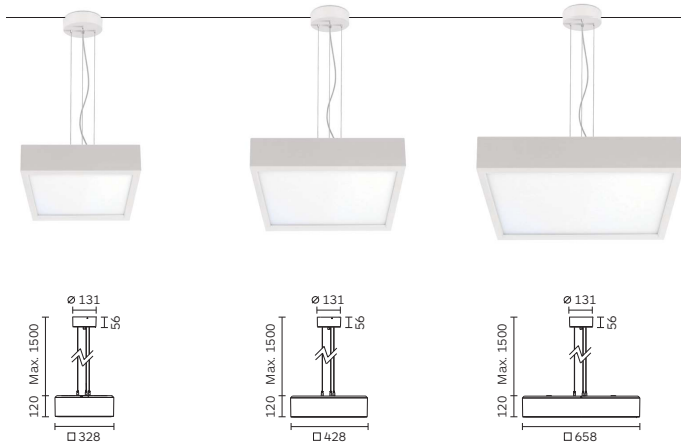

Code ordering example: 7 1 5 0 B M 1 1 - 9 0 3 0 0 0 0 1 1

	Product Code	Light Source Code*	>CRI	CCT**	LED Power	Nominal Lumen	Beam Angle (BA°)	Driver Options	Finish	
Quadro 300 Pendant Square	<b>7150</b>	<b>BM11</b> Samsung SMD	<b>90</b>	<b>30</b>	3000K	30W	1326 lm	EW (00)	<b>D0</b> No Dim	<b>11</b> □ White
				<b>40</b>	4000K		1425 lm		<b>DA</b> Dali Dim	
Quadro 400 Pendant Square	<b>7146</b>					45W	3978 lm		<b>DP</b> Phase Dim	
							4275 lm		<b>DC</b> CASAMBI	
Quadro 600 Pendant Square	<b>7143</b>					80W	7072 lm		<b>D1</b> 0-10V Dim	
							7600 lm			

### Notes:

\* For complete code ordering information, please see page 377.

\*\* For other CCT options, please contact us.

EW = Extra Wide. Ordering code: **00**.



# Sumo

Designed by Simon Fisher



## Body

Pendant high-bay luminaire with light housing in cast aluminium and Led modules holder in aluminium extrusion. Ceiling driver cup in thermoplastic material.

Fixture are supplied with ceiling cup, pre-installed 1.5 meter electrical wire and 1.5 meter steel wire.

## LED sources

Lumileds SMD LED.  
CRI: 90 | CCT: 3000K, 4000K.  
Other CRI and CCT options available on request.

## Optic

Optic lens array wide beam for uniform illumination in symmetric or asymmetric lighting distribution

## Accessories

No accessories available.

## Finish

Powder coat in black and grey colour.

## Driver

Inclusive of integrated no-dimable driver.  
Dimming Options: 0-10V Dim, DALI, Phase, CASAMBI

## Applications

An innovative concept of pendant high bay luminaire design that allows the functionality of both down lighting and wall washing keeping a uniform appearance. its unique design brings character and individuality to a space.  
Application areas: hospitality, retail, offices, residential.

## Related Products

**Conos  
Pendant**  
P.234



**DomoLED  
Pendant**  
P.238

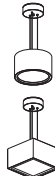

## Sumo Symmetrical & Asymmetrical



Sumo  
Pendant

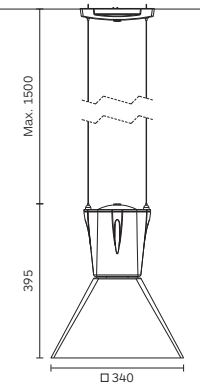

Code ordering example: **7 2 1 2 B P 3 1 - 9 0 3 0 2 5 D 0 9 2**

	Product Code	Light Source Code*	>CRI	CCT**	LED Power	Nominal Lumen	Beam Angle (BA°)	Driver Options	Finish
Sumo Symmetrical	<b>7212</b>	<b>BP31</b> Lumileds SMD	<b>90</b>	<b>30</b> 3000K	150W	14250 lm	<b>25/60/WW</b>	<b>DO</b> No Dim	<b>92</b> B&G
Sumo Asymmetrical	<b>7163</b>			<b>40</b> 4000K		15000 lm		<b>DA</b> Dali Dim <b>DP</b> Phase Dim <b>DC</b> CASAMBI <b>D1</b> 0-10V Dim	

### Notes:

\* For complete code ordering information, please see page 377.

\*\* For other CCT options, please contact us.

# Conos

## Pendant 154



## Body

Pendant mounted luminaire with light head and driver canopy in cast aluminium.

Product inclusive of 1.5 meter twin suspensions wires and one 1.5 meter electrical cables. Easy relamping via removable front housing by snap-in catch action. Provides user with ultimate flexibility of firm lamp position.

Tilttable vertically 0-90° and routable horizontally 0-350°.

## Accessories

Honeycomb louvre.

## Finish

Powder coat in black, white or grey colour.

## LED sources

Citizen CLU series.

CRI: 90, 95 | CCT: 3000K, 4000K.

Other CRI and CCT options, Tuneable White and DimToWarm versions available on request.

## Optic

Reflector.

Narrow, medium and wide beam angle available.

## Driver

Driver canopy inclusive of no-dimable driver.

Dimming Options: 0-10V Dim, DALI, Phase, CASAMBI.

## Applications

Extremely versatile pendant luminaire featuring a clean look adjustable to be accurately aimed. Ideal for high ceiling spaces and for local "task" lighting when placed over counters and tables.

Application areas: retail, hotels, restaurants, showrooms.

## Related Products



# Conos



## Conos 154 Pendant

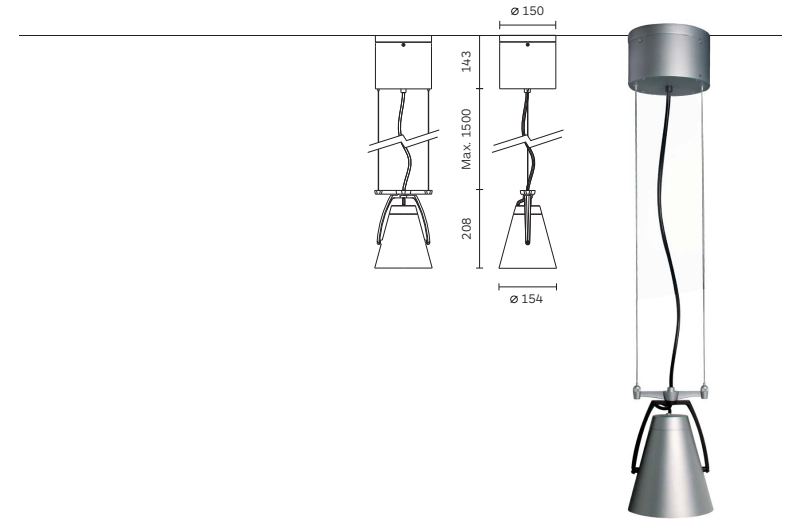

Code ordering example: **7 2 5 5 B C 2 1 - 9 0 3 0 1 4 D 0 1 0**

	Product Code	Light Source Code*	>CRI	CCT**	LED Power	Nominal Lumen	Beam Angle (BA°)	Driver Options	Finish
Conos 154	<b>7255</b>	<b>BC21</b> Citizen COB	<b>90</b>	<b>30</b> 3000K	30W	3728 lm	<b>14 / 24 / 38</b>	<b>D0</b> No Dim	<b>10</b> ■ Black
Pendant				<b>40</b> 4000K		3785 lm		<b>DA</b> Dali Dim	<b>11</b> □ White
								<b>DP</b> Phase Dim	<b>75</b> ■ Grey
								<b>DC</b> CASAMBI	
								<b>D1</b> 0-10V Dim	
								<b>DP</b> Phase Dim	
	<b>AR11</b> Retrofit	AR111-G53	<b>00</b>	<b>00</b>	/	/			

## Notes:

\* For complete code ordering information, please see page 377.

\*\* For other CCT options, please contact us.

# Miniluce

Pendant 900 | 1200 | 1500



## Body

Pendant mounted linear luminaire with luminaire body in extruded aluminium.

End caps in cast aluminium, diffuser made of satin opal acrylic.

Supplied with ceiling canopy, pre-installed 1.5m electrical cable and with 1.5m pendant steel wires. Available in 3 different length.

## Accessories

No accessories available.

## Finish

Powder coat in black, white or grey colour.

## LED sources

Samsung SMD LED.  
CRI: 90 | CCT: 3000K, 4000K.  
Other CRI and CCT options available on request.

## Optic

Equipped with acrylic satin opal diffuser.

## Driver

Inclusive of integrated no-dimable driver.  
Dimming Options: 0-10V Dim, DALI, CASAMBI.

## Applications

A simple and stylish design. The 3 directional emitting satin acrylic cover enables the architect and lighting designers the ability to integrate it into most applications including wet rooms.

Application areas: office, schools, gyms, community buildings, supermarkets, retail.

## Related Products

**Miniluce Surface**  
P.202



# Miniluce



**Miniluce 900 / 1200 / 1500**  
Pendant



Code ordering example: **7 1 1 5 B M 1 1 - 9 0 3 0 0 0 D 0 7 5**

	Product Code	Light Source Code*	>CRI	CCT**	LED Power	Nominal Lumen	Beam Angle (BA°)	Driver Options	Finish
Miniluce 900 Pendant	<b>7115</b>	<b>BM11</b> Samsung SMD	<b>90</b>	<b>30</b> 3000K	26W	2901 lm	EW ( <b>00</b> )	<b>D0</b> No Dim	<b>75</b> Grey
				<b>40</b> 4000K		3065 lm		<b>DA</b> Dali Dim	
Miniluce 1200 Pendant	<b>7116</b>				35W	3868 lm		<b>DC</b> CASAMBI	
						4087 lm		<b>D1</b> 0-10V Dim	
Miniluce 1500 Pendant	<b>7117</b>				44W	4835 lm			
						5109 lm			

## Notes:

\* For complete code ordering information, please see page 377.

\*\* For other CCT options, please contact us.

EW = Extra Wide. Ordering code: **00**.

# DomoLED

Pendant Round & Square 95 | 180 | 235



## Body

Round or square pendant mounted luminaire with light trim in cast aluminium inclusive of diffuser made of satin opal acrylic.

Light body in extruded aluminium.

Supplied with ceiling canopy, pre-installed 1.5m electrical cable and 1/3 1.5m pendant steel wires. Available in 3 different sizes.

## Accessories

No accessories available.

## Finish

Powder coat in black, white or grey colour.

## LED sources

Samsung SMD LED.

CRI: 90 | CCT: 3000K, 4000K.

Other CRI and CCT options available on request.

## Optic

Equipped with acrylic satin opal diffuser.

## Driver

Inclusive of integrated no-dimable driver.

Dimming Options: 0-10V Dim, DALI, Phase, CASAMBI.

## Applications

Provide visually comfortable energy-efficient with general illumination with architecturally sensitive aesthetics.

Application areas: offices, receptions, hospitals, bathrooms, canopy, residential, hotels.

## Related Products



# DomoLED Round



## DomoLED 95 / 180 / 235

Round Pendant

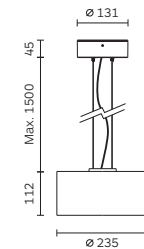
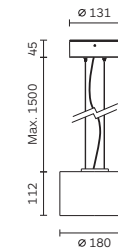
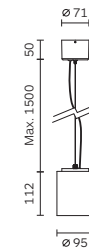

Code ordering example: **7 1 2 1 B M 1 1 - 9 0 3 0 0 0 D 0 1 0**

	Product Code	Light Source Code*	>CRI	CCT**	LED Power	Nominal Lumen	Beam Angle (BA°)	Driver Options	Finish
DomoLED 95 Round Pendant	<b>7121</b>	<b>BM11</b>	<b>90</b>	<b>30</b> 3000K	8W	928 lm	EW ( <b>00</b> )	<b>D0</b> No Dim	<b>10</b> ■ Black
				<b>40</b> 4000K		976 lm		<b>DA</b> Dali Dim	<b>11</b> □ White
DomoLED 180 Round Pendant	<b>7120</b>				22W	2552 lm		<b>DP</b> Phase Dim	<b>75</b> ■ Grey
						2684 lm		<b>DC</b> CASAMBI	
DomoLED 235 Round Pendant	<b>7119</b>				34W	3944 lm		<b>D1</b> 0-10V Dim	
						4148 lm			

## Notes:

\* For complete code ordering information, please see page 377.

\*\* For other CCT options, please contact us.

EW = Extra Wide. Ordering code: **00**.



## DomoLED Square



DomoLED 95 / 180 / 235  
Square Pendant

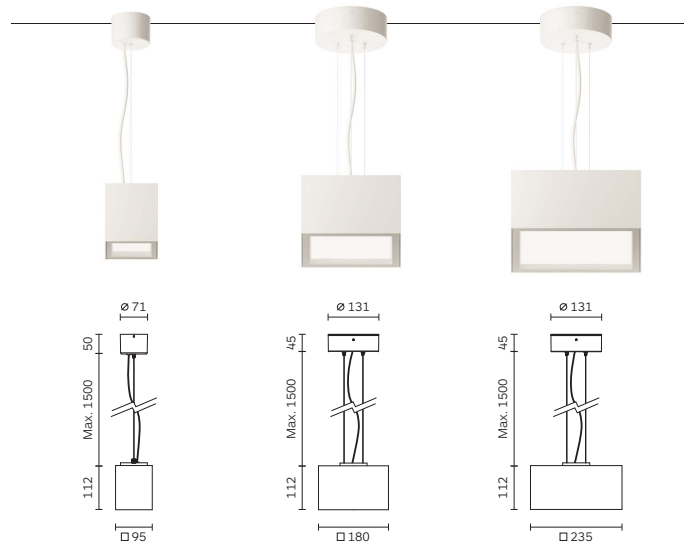

Code ordering example: 7124 BM11 - 90 30 00 D0 10

Product Code	Light Source Code*	>CRI	CCT**	LED Power	Nominal Lumen	Beam Angle (BA°)	Driver Options	Finish
DomoLED 95 Square Pendant	<b>7124</b> <b>BM11</b>	<b>90</b>	<b>30</b> 3000K	8W	928 lm	EW (00)	<b>D0</b> No Dim	<b>10</b> ■ Black
			<b>40</b> 4000K		976 lm		<b>DA</b> Dali Dim	<b>11</b> □ White
DomoLED 180 Square Pendant	<b>7123</b>			22W	2552 lm		<b>DP</b> Phase Dim	<b>75</b> ■ Grey
					2684 lm		<b>DC</b> CASAMBI	
DomoLED 235 Square Pendant	<b>7122</b>			34W	3944 lm		<b>D1</b> 0-10V Dim	
					4148 lm			

### Notes:

- \* For complete code ordering information, please see page 377.
  - \*\* For other CCT options, please contact us.
- EW = Extra Wide. Ordering code: **00**.

## DomoLED Family configuration options

Code ordering example: 7121 BM11 - 90 30 00 D0 10

### DomoLED 95 Round & Square

Pendant

Product Code	Light Source Code	>CRI	CCT	LED Power	Nominal Lumen	Beam Angle (BA°)	Driver Options	Finish
<b>7121</b> Round	<b>BM11</b> Samsung SMD	<b>90</b>	<b>30</b> 3000K	8W	928 lm	EW (00)	<b>D0</b> No Dim	<b>10</b> ■ Black
<b>7124</b> Square			<b>40</b> 4000K		976 lm		<b>DA</b> Dali Dim	<b>11</b> □ White
							<b>DP</b> Phase Dim	<b>75</b> ■ Grey
							<b>DC</b> CASAMBI	
							<b>D1</b> 0-10V Dim	

### DomoLED 180 Round & Square

Pendant

Product Code	Light Source Code	>CRI	CCT	LED Power	Nominal Lumen	Beam Angle (BA°)	Driver Options	Finish
<b>7120</b> Round	<b>BM11</b> Samsung SMD	<b>90</b>	<b>30</b> 3000K	22W	2252 lm	EW (00)	<b>D0</b> No Dim	<b>10</b> ■ Black
<b>7123</b> Square			<b>40</b> 4000K		2684 lm		<b>DA</b> Dali Dim	<b>11</b> □ White
							<b>DP</b> Phase Dim	<b>75</b> ■ Grey
							<b>DC</b> CASAMBI	
							<b>D1</b> 0-10V Dim	

### DomoLED 235 Round & Square

Pendant

Product Code	Light Source Code	>CRI	CCT	LED Power	Nominal Lumen	Beam Angle (BA°)	Driver Options	Finish
<b>7119</b> Round	<b>BM11</b> Samsung SMD	<b>90</b>	<b>30</b> 3000K	34W	3944 lm	EW (00)	<b>D0</b> No Dim	<b>10</b> ■ Black
<b>7122</b> Square			<b>40</b> 4000K		4148 lm		<b>DA</b> Dali Dim	<b>11</b> □ White
							<b>DP</b> Phase Dim	<b>75</b> ■ Grey
							<b>DC</b> CASAMBI	
							<b>D1</b> 0-10V Dim	

### Notes:

For other CCT options, please contact us.

# PicoLED

## Showcase



## Body

Recessed under cabinet/shelf downlight. Trim with integrated heat sink in cast aluminium and front clear lens holder made in polycarbonate.

Minimum panel depth for installation 18mm. Quick and easy installation via concealed springs for snap-in catch action.

Fixtures are supplied with pre-wired 300 mm cable inclusive of female plug with multi-unit connectors to allow easy wiring.

## Accessories

Electronic power supply unit, extension cable, led controller.

## Finish

Powder coat in white colour.

## LED sources

Nichia single power led.  
CRI: 90 | CCT: 3000K, 4000K.  
Other CRI and CCT options available on request.

## Optic

Collimating lens made of optical polymer or diffuser for extra wide beam.

## Driver

Driver not included to be order separately.  
Dimming Options: No-Dim, 1-10V Dim, DALI, Phase, CASAMBI.

## Applications

A fixture of very miniature size achieving a disappearing look and with the option to easy interchange lens allowing different beam selections; available, upon with RGB/W option.  
Application areas: showcases, cabinet displays, museums, under-cabinet, undershelf, residential, restaurants.

## Related Products



# PicoLED



**PicoLED**  
Showcase

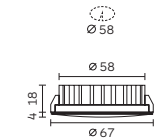

## LED Driver Measurements

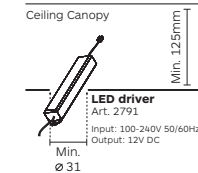

## Single Colour Wiring Diagram

Single-unit connection

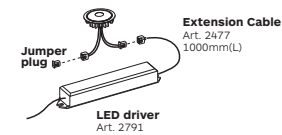

## Single Colour Wiring Diagram

Multi-unit connection

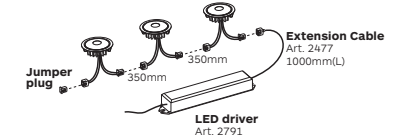

Code ordering example: **RB04BN11-9030120011**

	Product Code	Light Source Code*	>CRI	CCT**	LED Power	Nominal Lumen	Beam Angle (BA°)	Driver Options	Finish
PicoLED Showcase	<b>RB04</b>	<b>BN11</b> Nichia Single LED	<b>90</b>	<b>30</b> 3000K	<b>2W</b>	201 lm	<b>12 / EW (00)</b>	<b>00</b> No Driver	<b>11</b> □ White
				<b>40</b> 4000K		217 lm		<b>D0</b> No Dim	
								<b>DA</b> Dali Dim	
								<b>DP</b> Phase Dim	
								<b>DC</b> CASAMBI	
								<b>D1</b> 0-10V Dim	

## Notes:

\* For complete code ordering information, please see page 377.

\*\* For other CCT options, please contact us.

EW = Extra Wide. Ordering code: **00**.

# Flexstrip

## Showcase



## Body

Flexible strip lighting solutions. Light strips with 3M double-sided tape included and usually supplied in 5 meter spools.

The number of LED/m is according with the chosen model.

Easy to install due to double sided tapes that allow it to even go around corners or make graceful curves.

## LED sources

Led strip. Standard configuration 5 meter spool, with 300 led per spool. For customized lengths, please contact us. Minimum cutting unit: 3 LEDs. CRI: 90 | CCT: 2700K, 6500K. Other CRI, CCT, single colour options available on request.

## Optic

No optics available

## Accessories

Fastening brackets, electronic power supply unit.

## Finish

No finish colour.

## Driver

Driver not included to be order separately.

## Applications

Strip light with a low profile and very minimal heat emission; it is so dynamically useful to be used in a multitude of applications and very easy to install due to strip design including 3M double-sided tape. Applications areas: cove edge, wine cellars, under cabinet, display cases, bedroom, retail, restaurants, casinos, gardens, water features.

## Related Products

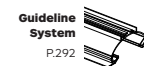

**Guideline System**  
P.292

# Flexstrip



## FlexstripLED

Showcase

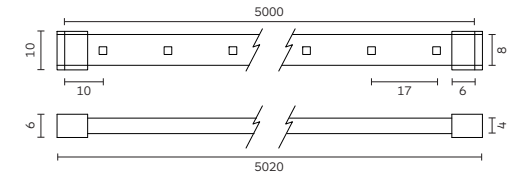

Code ordering example: **4 2 0 4 5 0 0 0 - 9 0 2 7 0 0 0 0 0 0**

	Product Code	Length Code*	>CRI	CCT**	LED Power	Nominal Lumen	Beam Angle (BA°)	Driver Options	Finish
Flexstrip IP20	<b>4204</b>	<b>5000</b> 5000mm LED strip	<b>90</b>	<b>27</b> 2700K	24W	1800 lm	<b>00</b>	<b>00</b> No Driver	<b>00</b> No finish
				<b>65</b> 6500K		2256 lm			
Flexstrip IP66	<b>4205</b>								
Flexstrip IP20	<b>4208</b>					72W	5688 lm		
							7200 lm		
Flexstrip IP66	<b>4209</b>								

## Optical Accessories

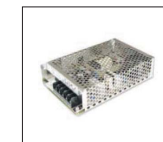

Product / Optical Accessories

### Power Supply

Electronic Transformer for LED.  
Input 220-240V 50/60Hz.  
Output 12V DC.  
Max. 100W.  
Max. 20m with Art. 4204 and 4205.  
Max. 6.5m with Art. 4208 and 4209.

Flexstrip

**2924**

## Notes:

\* For complete code ordering information, please see page 377.

\*\* For other CCT options, please contact us.

# MonoLED/GiroLED/QuadroLED

## Showcase



## Body

Round or square recessed spotlight. Luminaire body in cast aluminium with optimal passive thermal management.

Quick and easy installation via concealed springs for snap-in catch action for minimum ceiling thickness. Supplied pre-wired with 240mm cable and male/female plugs ready to plug-in (multi or single unit) to power LED converter unit.

Adjustable versions tiltable vertically 0-25° and rotatable horizontally 350°.

## LED sources

Nichia single power led.  
CRI: 90 | CCT: 3000K, 4000K.  
Other CRI and CCT options available on request.

## Optic

Lens.  
Narrow and wide beam angle available.

## Accessories

Extension cable.

## Driver

Remote driver not included to be order separately.

## Finish

Powder coat in black, white or grey colour.

## Applications

Miniature recessed luminaires with a disappearing look and ideal for display and under cabinet illumination.  
Application areas: cabinet displays, showcases, under-cabinet, undershelf, retail, residential, restaurants, galleries, museums, showroom.

## Related Products



## MonoLED



**MonoLED**  
Showcase

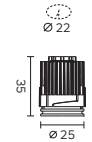

Code ordering example: 2 9 7 4 B N 1 1 - 9 0 3 0 1 4 0 0 1 0

	Product Code	Light Source Code*	>CRI	CCT**	LED Power	Nominal Lumen	Beam Angle (BA°)	Driver Options	Finish
MonoLED	<b>2974</b>	<b>BN11</b> Nichia Single LED	<b>90</b>	<b>30</b> 3000K	2W	150 lm	<b>14 / 40</b>	<b>00</b> No Driver	<b>10</b> ■ Black
Showcase				<b>40</b> 4000K		162 lm			
				<b>BL</b> <b>UE</b> BLUE		/			
				<b>RE</b> <b>DO</b> RED					
				<b>GR</b> <b>EN</b> GREEN					
				<b>YE</b> <b>LL</b> YELLOW					
				<b>RG</b> <b>BO</b> RGB	3x1W				
				<b>RG</b> <b>BW</b> RGBW					

## Notes:

\* For complete code ordering information, please see page 377.

\*\* For other CCT options, please contact us.

For related accessories, please see page 249.

# GiroLED / GiroLED Deep / QuadroLED

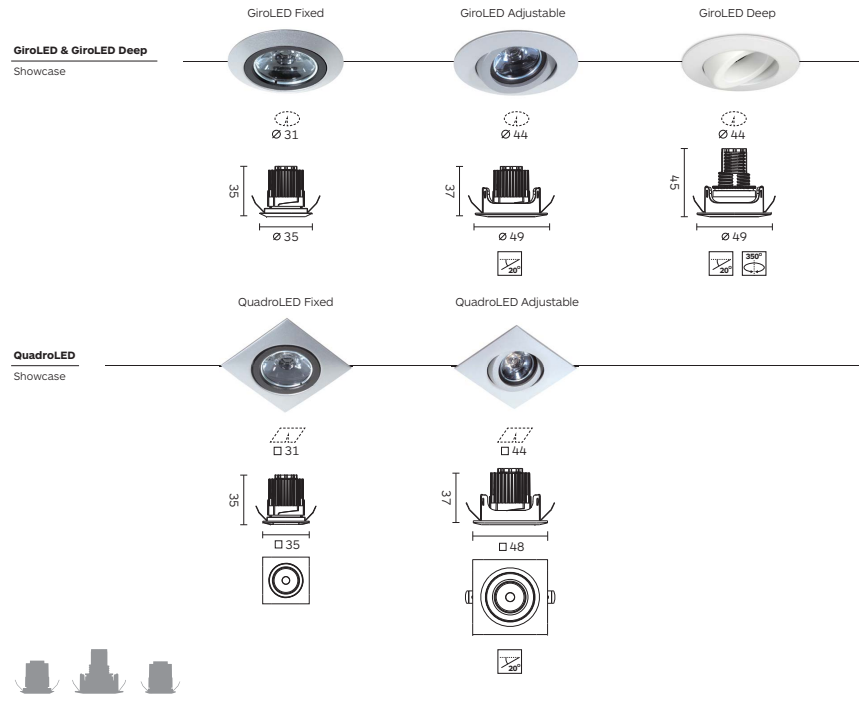

Code ordering example: **RD37BN11-9030140010**

	Product Code	Light Source Code*	>CRI	CCT**	LED Power	Nominal Lumen	Beam Angle (BA°)	Driver Options	Finish
GiroLED Fixed	<b>RD37</b>	<b>BN11</b> Nichia Single LED	<b>90</b>	<b>30</b>	3000K 2W	150 lm	<b>14 / 40</b>	<b>00</b> No Driver	<b>10</b> ■ Black
GiroLED Adjustable	<b>RD39</b>			<b>40</b>	4000K	162 lm			<b>11</b> □ White
GiroLED Deep	<b>RH34</b>			<b>BL</b>	<b>UE</b> BLUE	/			<b>34</b> ■ Nickel
QuadroLED Fixed	<b>RD38</b>			<b>RE</b>	<b>DO</b> RED				<b>75</b> ■ Grey
QuadroLED Adjustable	<b>RD40</b>			<b>GR</b>	<b>EN</b> GREN				
				<b>YE</b>	<b>LL</b> YELL				
				<b>RG</b>	<b>BO</b> RGB 3x1W				
				<b>RG</b>	<b>BW</b> RGBW				

**Notes:**  
 \* For complete code ordering information, please see page 377.  
 \*\* For other CCT options, please contact us.  
 For related accessories, please see page 249.

# Optical Accessories

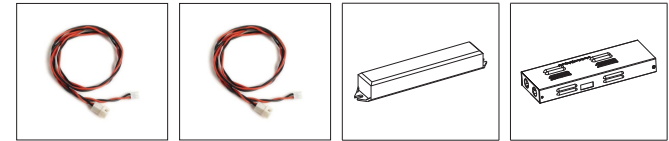

Product / Optical Accessories	Extension Cable	Extension Cable	Electronic LED Driver	DMX LED Driver
	For single colour L: 1000mm	For RGB L: 1000mm	Input: 220-240V 50/60Hz For 1-6 pcs LED 2W 500mA	DMX driver and power supply unit. Input: 100-240V 50/60Hz For 2-12 pcs MonoLED RGB
MonoLED				<b>2986</b>
GiroLED	<b>2477</b>	<b>2983</b>	<b>2790</b>	/
GiroLED Deep				/
QuadroLED				/

## LED Driver Measurements

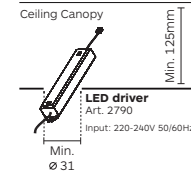

## Single Colour Wiring Diagram

Single-unit connection

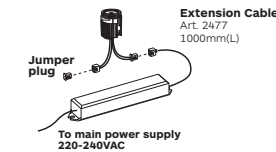

## Single Colour Wiring Diagram

Multi-unit connection

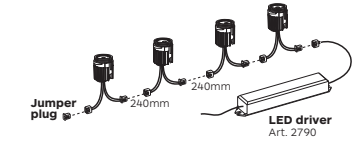

## LED Driver Measurements

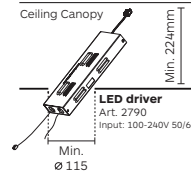

## RGB Wiring Diagram

Multi-unit connection

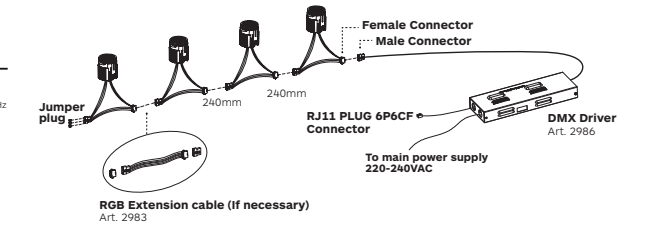

# Indoor Systems

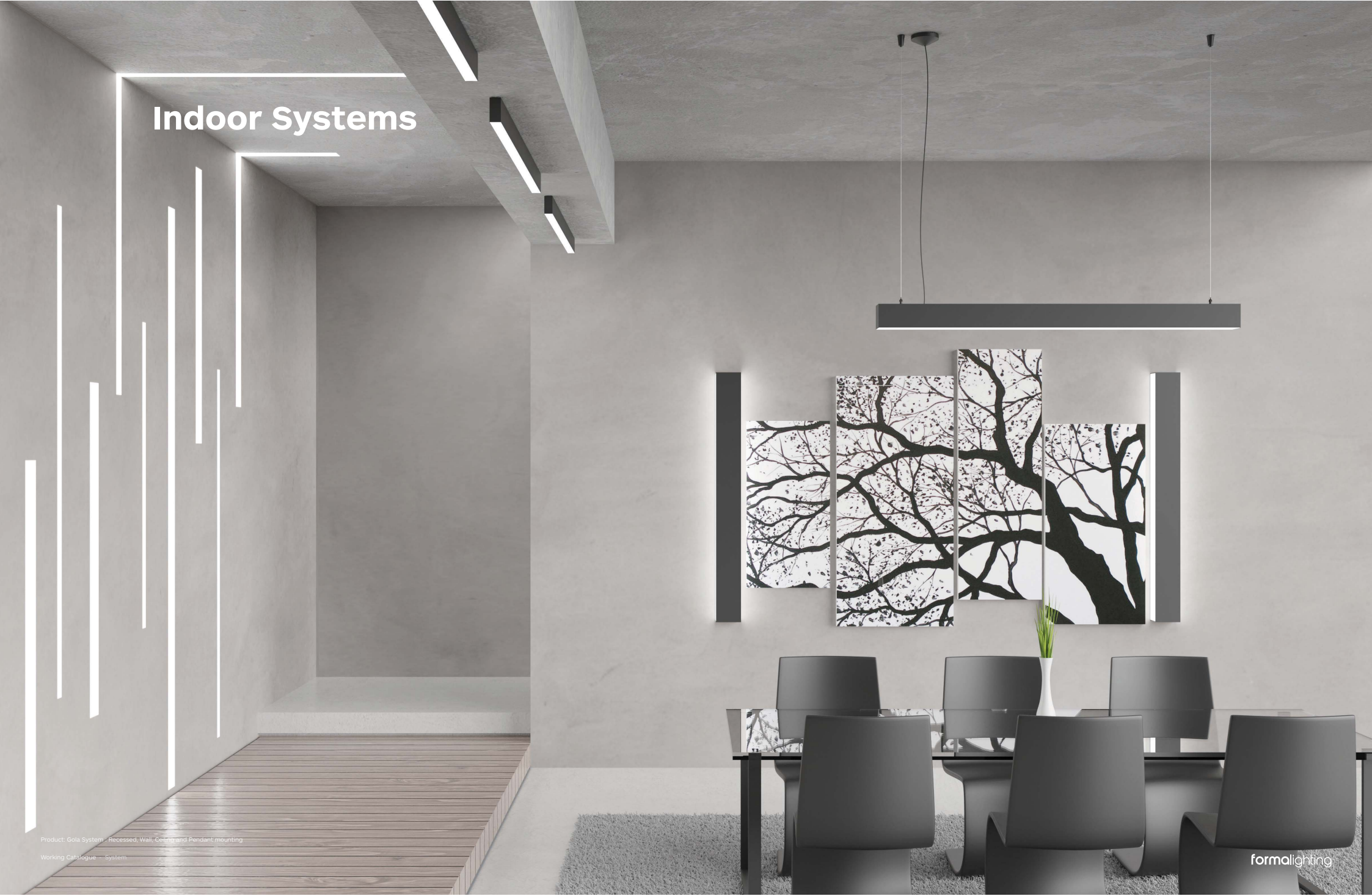

Product: Gola System - Recessed, Wall, Ceiling and Pendant mounting

Working Catalogue - System

formalighting

# Gola System

40 | 60 | 95 | 160

Recessed

Wall

Ceiling

Pendant

## Code system for Gola series

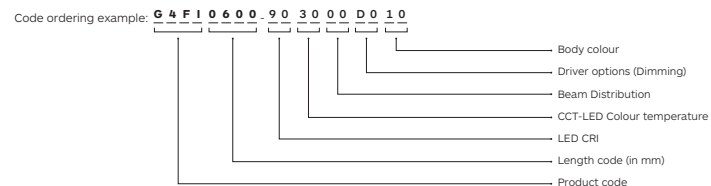

Gola width code	Module location code	Mounting type code	Gola length code	LED CRI	CCT-LED	Driver Options	Body colour
<b>4</b> 40 mm	<b>I</b> Initial/ End	<b>F</b> Trim	<b>0568</b> 568 mm	<b>90</b> >90	<b>30</b> Warm White 3000K	<b>D0</b> No dimming	<b>10</b> Black
<b>6</b> 60 mm	<b>B</b> Middle	<b>M</b> Trimless	<b>0848</b> 848 mm		<b>40</b> Neutral White 4000K	<b>DA</b> Dali Dim	<b>11</b> White
<b>9</b> 95 mm	<b>S</b> Stand alone	<b>N</b> Surface	<b>1128</b> 1128 mm			<b>DP</b> Phase	<b>75</b> Grey
<b>1</b> 160 mm		<b>W</b> Wall	<b>1408</b> 1408 mm			<b>D1</b> 0-10 Dim	
		<b>C</b> Wall Up & Down				<b>DC</b> CASAMBI	
		<b>P</b> Pendant					
		<b>U</b> Pendant Up & Down					

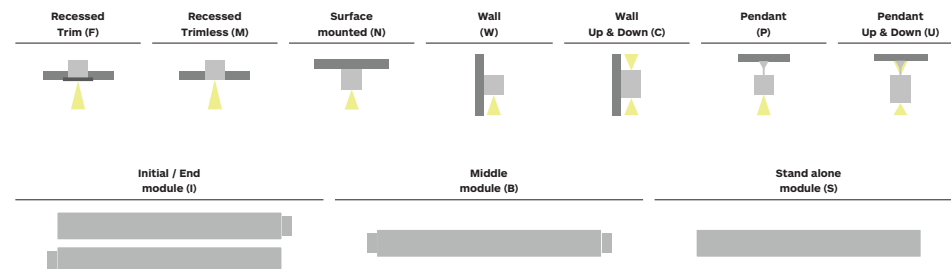

## How to order

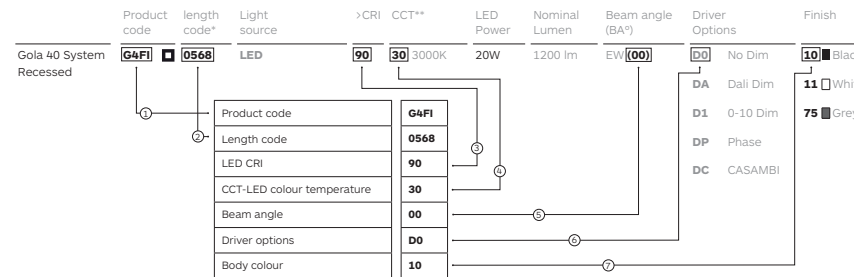

**Notes:**

\* For other bespoke length options, please contact us.  
 \*\* For other CCT options, please contact us.  
 EW = Extra Wide. Ordering code: **00**.

# Gola System

40 | 60 | 95 | 160 Recessed



## Body

Recessed trim or trimless linear luminaire system with installation via adjustable brackets.

Luminaire housing in extruded aluminium and end caps in cast aluminium. Satin white diffuser in extruded UV heat resistant acrylic. End caps are mechanically attached with no exposed fasteners.

Available in four width apertures (40-60-95-160mm) and mountable vertically or horizontally.

System versions can be configured into linear, 90 ° L, T and X shapes or other custom configurations (details are all by request).

Gola 95 and 160 can incorporate spotlight modules. Optional Gimbal light head module with tiltable and rotatable heads for Gola 95 and 160.

## Accessories

For a complete list of modules and accessories see page 277.

## Finish

Powder coat in black, white and grey colour.

## LED sources

SMD modular system.  
CRI: 90 | CCT: 3000K, 4000K.

Other CRI and CCT options, Tuneable White, DimToWarm and RGB/W versions available on request.

## Optic

Acrylic opal white diffuser.

## Driver

Inclusive of integrated no-dimable driver.  
Dimming Options: 0-10V Dim, DALI, Phase, CASAMBI.

## Applications

Linear system with multiple mounting options to enabling continuous runs of infinite length. It offers the possibility to equipped entire projects with a single product ensuring consistent illumination despite varying ceiling heights  
Application areas: offices, hallways, schools, cafeterias.

### Related Products

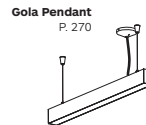
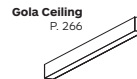
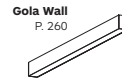

## Gola 40 System



### Gola 40 System

Trim

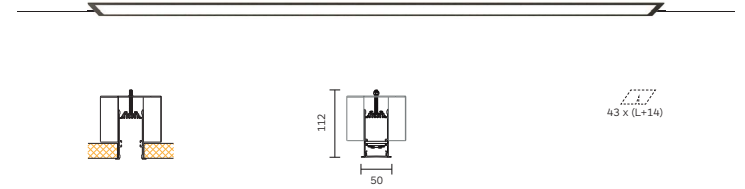

### Gola 40 System

Trimless

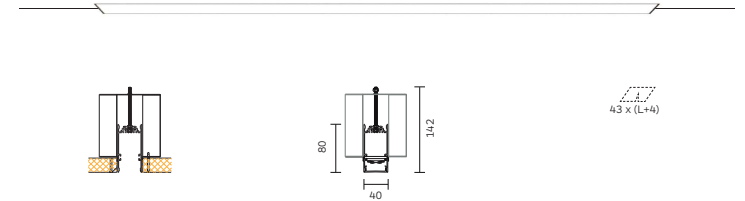

Code ordering example: **G 4 F I 0 5 6 8 - 9 0 3 0 0 0 D 0 1 0**

	Product code	length code*	Light source	>CRI	CCT**	LED Power	Nominal Lumen	Beam angle (BA°)	Driver Options	Finish
Gola 40 System Recessed	<b>G4FI</b> <input checked="" type="checkbox"/>	<b>0568</b>	<b>LED</b>	<b>90</b>	<b>30</b> 3000K	12.2W	2200 lm	<b>EW (00)</b>	<b>DO</b> No Dim	<b>10</b> <input checked="" type="checkbox"/> Black
	<b>G4MI</b> <input type="checkbox"/>				<b>40</b> 4000K		2400 lm		<b>DA</b> Dali Dim	<b>11</b> <input type="checkbox"/> White
	<b>G4FB</b> <input checked="" type="checkbox"/>	<b>0848</b>				18.3W	3300 lm		<b>D1</b> 0-10 Dim	<b>75</b> <input type="checkbox"/> Grey
	<b>G4MB</b> <input type="checkbox"/>						3600 lm		<b>DP</b> Phase	
	<b>G4FS</b> <input checked="" type="checkbox"/>	<b>1128</b>				24.4W	4400 lm		<b>DC</b> CASAMBI	
	<b>G4MS</b> <input type="checkbox"/>						4800 lm			
		<b>1408</b>					30.5W	5500 lm		
								6000 lm		

### Notes:

\* For complete code ordering information, please see page 253.

\*\* For other CCT options, please contact us.

For related accessories, please see page 277.

EW = Extra Wide. Ordering code: **00**.



## Gola 60 System



### Gola 60 System

Trim

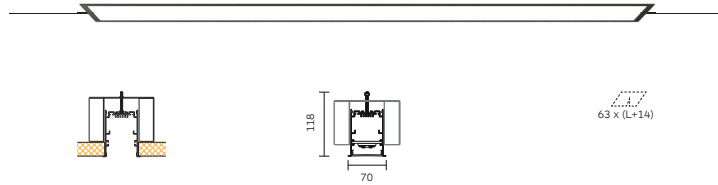

### Gola 60 System

Trimless

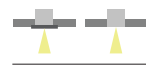
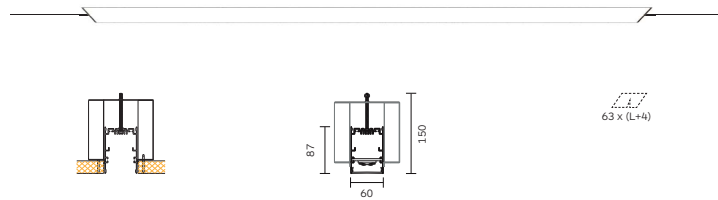

Code ordering example: **G 6 F I 0 5 6 8 - 9 0 3 0 0 0 D 0 1 0**

	Product code	length code*	Light source	>CRI	CCT**	LED Power	Nominal Lumen	Beam angle (BA°)	Driver Options	Finish
Gola 60 System Recessed	<b>G6FI</b> <input checked="" type="checkbox"/>	<b>0568</b>	<b>LED</b>	<b>90</b>	<b>30</b> 3000K	12.2W	2200 lm	<b>EW (00)</b>	<b>D0</b> No Dim	<b>10</b> <input checked="" type="checkbox"/> Black
	<b>G6MI</b> <input type="checkbox"/>				<b>40</b> 4000K		2400 lm		<b>DA</b> Dali Dim	<b>11</b> <input type="checkbox"/> White
	<b>G6FB</b> <input checked="" type="checkbox"/>	<b>0848</b>				18.3W	3300 lm		<b>D1</b> 0-10 Dim	<b>75</b> <input checked="" type="checkbox"/> Grey
	<b>G6MB</b> <input type="checkbox"/>						3600 lm		<b>DP</b> Phase	
	<b>G6FS</b> <input checked="" type="checkbox"/>	<b>1128</b>				24.4W	4400 lm		<b>DC</b> CASAMBI	
	<b>G6MS</b> <input type="checkbox"/>						4800 lm			
		<b>1408</b>				30.5W	5500 lm			
							6000 lm			

#### Notes:

\* For complete code ordering information, please see page 253.  
 \*\* For other CCT options, please contact us.  
 For related accessories, please see page 277.  
 EW = Extra Wide. Ordering code: **00**.

## Gola 95 System



### Gola 95 System

Trim

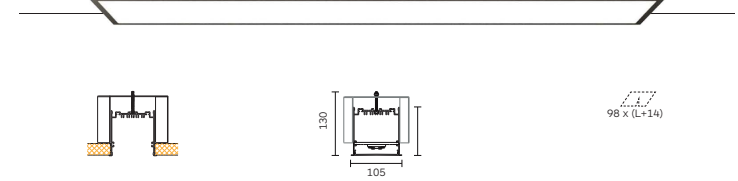

### Gola 95 System

Trimless

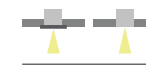
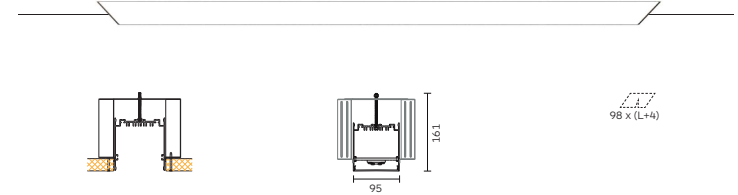

Code ordering example: **G 9 F I 0 5 6 8 - 9 0 3 0 0 0 D 0 1 0**

	Product code	length code*	Light source	>CRI	CCT**	LED Power	Nominal Lumen	Beam angle (BA°)	Driver Options	Finish
Gola 95 System Recessed	<b>G9FI</b> <input checked="" type="checkbox"/>	<b>0568</b>	<b>LED</b>	<b>90</b>	<b>30</b> 3000K	24.4W	4400 lm	<b>EW (00)</b>	<b>D0</b> No Dim	<b>10</b> <input checked="" type="checkbox"/> Black
	<b>G9MI</b> <input type="checkbox"/>				<b>40</b> 4000K		4800 lm		<b>DA</b> Dali Dim	<b>11</b> <input type="checkbox"/> White
	<b>G9FB</b> <input checked="" type="checkbox"/>	<b>0848</b>				36.6W	6600 lm		<b>D1</b> 0-10 Dim	<b>75</b> <input checked="" type="checkbox"/> Grey
	<b>G9MB</b> <input type="checkbox"/>						7200 lm		<b>DP</b> Phase	
	<b>G9FS</b> <input checked="" type="checkbox"/>	<b>1128</b>				48.8W	8800 lm		<b>DC</b> CASAMBI	
	<b>G9MS</b> <input type="checkbox"/>						9600 lm			
		<b>1408</b>				61W	11000 lm			
							12000 lm			

#### Notes:

\* For complete code ordering information, please see page 253.  
 \*\* For other CCT options, please contact us.  
 For related accessories, please see page 277.  
 EW = Extra Wide. Ordering code: **00**.

# Gola 160 System



Gola 160 System  
Trimless



160 x (L+4)

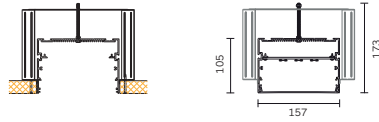

Code ordering example: G 1 F I 0 5 6 8 - 9 0 3 0 0 0 0 0 1 0

	Product code	length code*	Light source	>CRI	CCT**	LED Power	Nominal Lumen	Beam angle (BA°)	Driver Options	Finish
Gola 160 System Recessed	<b>G1FI</b> <input type="checkbox"/>	<b>0568</b>	<b>LED</b>	<b>90</b>	<b>30</b> 3000K	36.6W	6600 lm	<b>EW (00)</b>	<b>D0</b> No Dim	<b>10</b> <input type="checkbox"/> Black
					<b>40</b> 4000K	7200 lm	<b>DA</b> Dali Dim	<b>11</b> <input type="checkbox"/> White		
	<b>G1FB</b> <input type="checkbox"/>	<b>0848</b>				54.9W	9900 lm		<b>D1</b> 0-10 Dim	<b>75</b> <input type="checkbox"/> Grey
							10800 lm		<b>DP</b> Phase	
		<b>G1FS</b> <input type="checkbox"/>	<b>1128</b>			73.2W	13200 lm		<b>DC</b> CASAMBI	
							14400 lm			
		<b>1408</b>			91.5W	16500 lm				
							18000 lm			

**Notes:**  
 \* For complete code ordering information, please see page 253.  
 \*\* For other CCT options, please contact us.  
 For related accessories, please see page 277.  
 EW = Extra Wide. Ordering code: **00**.

# Gola Recessed System Family configuration options

Code ordering example: G 4 F I 0 5 6 8 - 9 0 3 0 0 0 0 1 0

## Gola 40 System Recessed

Product code	length code*	Light source	>CRI	CCT	LED Power	Nominal Lumen	Beam angle (BA°)	Driver Options	Finish
<b>G4FS</b> <input type="checkbox"/>	<b>0568</b>	<b>LED</b>	<b>90</b>	<b>30</b> 3000K	12.2W	2200 lm	<b>EW (00)</b>	<b>D0</b> No Dim	<b>10</b> <input type="checkbox"/> Black
<b>G4MI</b> <input type="checkbox"/>				<b>40</b> 4000K		2400 lm		<b>DA</b> Dali Dim	<b>11</b> <input type="checkbox"/> White
<b>G4FB</b> <input type="checkbox"/>	<b>0848</b>				18.3W	3300 lm		<b>D1</b> 0-10 Dim	<b>75</b> <input type="checkbox"/> Grey
<b>G4MI</b> <input type="checkbox"/>						3600 lm		<b>DP</b> Phase	
<b>G4FS</b> <input type="checkbox"/>	<b>1128</b>				24.4W	4400 lm		<b>DC</b> CASAMBI	
<b>G4MB</b> <input type="checkbox"/>						4800 lm			
	<b>1408</b>				30.5W	5500 lm			
						6000 lm			

## Gola 60 System Recessed

Product code	length code*	Light source	>CRI	CCT	LED Power	Nominal Lumen	Beam angle (BA°)	Driver Options	Finish
<b>G6FB</b> <input type="checkbox"/>	<b>0568</b>	<b>LED</b>	<b>90</b>	<b>30</b> 3000K	12.2W	2200 lm	<b>EW (00)</b>	<b>D0</b> No Dim	<b>10</b> <input type="checkbox"/> Black
<b>G6MS</b> <input type="checkbox"/>				<b>40</b> 4000K		2400 lm		<b>DA</b> Dali Dim	<b>11</b> <input type="checkbox"/> White
<b>G6FI</b> <input type="checkbox"/>	<b>0848</b>				18.3W	3300 lm		<b>D1</b> 0-10 Dim	<b>75</b> <input type="checkbox"/> Grey
<b>G6MB</b> <input type="checkbox"/>						3600 lm		<b>DP</b> Phase	
<b>G6FI</b> <input type="checkbox"/>	<b>1128</b>				24.4W	4400 lm		<b>DC</b> CASAMBI	
<b>G6MS</b> <input type="checkbox"/>						4800 lm			
	<b>1408</b>				30.5W	5500 lm			
						6000 lm			

## Gola 95 System Recessed

Product code	length code*	Light source	>CRI	CCT	LED Power	Nominal Lumen	Beam angle (BA°)	Driver Options	Finish
<b>G9FI</b> <input type="checkbox"/>	<b>0568</b>	<b>LED</b>	<b>90</b>	<b>30</b> 3000K	24.4W	4400 lm	<b>EW (00)</b>	<b>D0</b> No Dim	<b>10</b> <input type="checkbox"/> Black
<b>G9MB</b> <input type="checkbox"/>				<b>40</b> 4000K		4800 lm		<b>DA</b> Dali Dim	<b>11</b> <input type="checkbox"/> White
<b>G9FS</b> <input type="checkbox"/>	<b>0848</b>				36.6W	6600 lm		<b>D1</b> 0-10 Dim	<b>75</b> <input type="checkbox"/> Grey
<b>G9MB</b> <input type="checkbox"/>						7200 lm		<b>DP</b> Phase	
<b>G9FS</b> <input type="checkbox"/>	<b>1128</b>				48.8W	8800 lm		<b>DC</b> CASAMBI	
<b>G9MI</b> <input type="checkbox"/>						9600 lm			
	<b>1408</b>				61W	11000 lm			
						12000 lm			

## Gola 160 System Recessed

Product code	length code*	Light source	>CRI	CCT	LED Power	Nominal Lumen	Beam angle (BA°)	Driver Options	Finish
<b>G1FI</b> <input type="checkbox"/>	<b>0568</b>	<b>LED</b>	<b>90</b>	<b>30</b> 3000K	36.6W	6600 lm	<b>EW (00)</b>	<b>D0</b> No Dim	<b>10</b> <input type="checkbox"/> Black
				<b>40</b> 4000K		7200 lm		<b>DA</b> Dali Dim	<b>11</b> <input type="checkbox"/> White
<b>G1FB</b> <input type="checkbox"/>	<b>0848</b>				54.9W	9900 lm		<b>D1</b> 0-10 Dim	<b>75</b> <input type="checkbox"/> Grey
						10800 lm		<b>DP</b> Phase	
<b>G1FS</b> <input type="checkbox"/>	<b>1128</b>				73.2W	13200 lm		<b>DC</b> CASAMBI	
						14400 lm			
	<b>1408</b>				91.5W	16500 lm			
						18000 lm			

**Notes:**  
 For other CCT options, please contact us.

# Gola System

40 | 60 | 95 | 160 Surface Wall



## Body

Surface mounted linear luminaire system. Luminaire housing in extruded aluminium and end caps in cast aluminium. Satin white diffuser in extruded UV heat resistant acrylic. End caps are mechanically attached with no exposed fasteners. Available in four width apertures (40-60-95-160mm).

Optional Gimbal light head module with tiltable and routable heads for Gola 95 and 160.

## Accessories

For a complete list of modules and accessories see page 277.

## Finish

Powder coat in black, white and grey colour.

## LED sources

SMD modular system. CRI: 90 | CCT: 3000K, 4000K.

Other CRI and CCT options, Tuneable White, DimToWarm and RGB/W versions available on request.

## Optic

Acrylic opal white diffuser.

## Driver

Inclusive of integrated no-dimable driver. Dimming Options: 0-10V Dim, DALI, Phase, CASAMBI.

## Applications

Linear system with multiple mounting options to enabling continuous runs of infinite length. It offers the possibility to equipped entire projects with a single product ensuring consistent illumination despite varying ceiling heights. Application areas: offices, hallways, schools, cafeterias.

## Related Products

**Gola Recessed**  
P. 254



**Gola Ceiling**  
P. 266



**Gola Pendant**  
P. 270

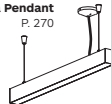

# Gola 40 System



## Gola 40 System

Wall



## Gola 40 System

Wall Direct & Indirect



Code ordering example: **G 4 W I 0 5 6 8 - 9 0 3 0 0 0 D 0 1 0**

	Product code	length code*	Light source	>CRI	CCT**	LED Power	Nominal Lumen	Beam angle (BA°)	Driver Options	Finish
Gola 40 System Wall	<b>G4WI</b>	<b>0568</b>	<b>LED</b>	<b>90</b>	<b>30</b> 3000K	12.2W	2200 lm	EW ( <b>00</b> )	<b>D0</b> No Dim	<b>10</b> ■ Black
	<b>G4WB</b>				<b>40</b> 4000K		2400 lm		<b>DA</b> Dali Dim	<b>11</b> □ White
	<b>G4WS</b>	<b>0848</b>				18.3W	3300 lm		<b>D1</b> 0-10 Dim	<b>75</b> ■ Grey
							3600 lm		<b>DP</b> Phase	
Gola 40 System Wall Direct & Indirect	<b>G4CI</b>	<b>1128</b>				24.4W	4400 lm		<b>DC</b> CASAMBI	
	<b>G4CB</b>						4800 lm			
	<b>G4CS</b>	<b>1408</b>				30.5W	5500 lm			
							6000 lm			

## Notes:

\* For complete code ordering information, please see page 253.

\*\* For other CCT options, please contact us.

For related accessories, please see page 277.

EW = Extra Wide. Ordering code: **00**.

## Gola 60 System



### Gola 60 System

Wall

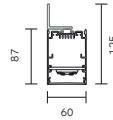

Code ordering example: **G 6 W I 0 5 6 8 - 9 0 3 0 0 0 D 0 1 0**

	Product code	length code*	Light source	>CRI	CCT**	LED Power	Nominal Lumen	Beam angle (BA°)	Driver Options	Finish
Gola 60 System	<b>G6WI</b>	<b>0568</b>	<b>LED</b>	<b>90</b>	<b>30</b> 3000K	12.2W	2200 lm	EW ( <b>00</b> )	<b>D0</b> No Dim	<b>10</b> ■ Black
Wall	<b>G6WB</b>				<b>40</b> 4000K		2400 lm		<b>DA</b> Dali Dim	<b>11</b> □ White
	<b>G6WS</b>	<b>0848</b>				18.3W	3300 lm		<b>D1</b> 0-10 Dim	<b>75</b> ■ Grey
							3600 lm		<b>DP</b> Phase	
		<b>1128</b>					24.4W	4400 lm	<b>DC</b> CASAMBI	
							4800 lm			
		<b>1408</b>					30.5W	5500 lm		
							6000 lm			

#### Notes:

\* For complete code ordering information, please see page 253.  
 \*\* For other CCT options, please contact us.  
 For related accessories, please see page 277.  
 EW = Extra Wide. Ordering code: **00**.

## Gola 95 System



### Gola 95 System

Wall

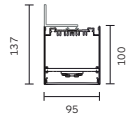

### Gola 95 System

Wall Direct & Indirect

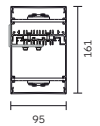
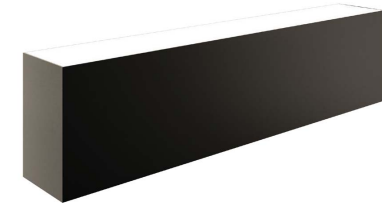

Code ordering example: **G 9 W I 0 5 6 8 - 9 0 3 0 0 0 D 0 1 0**

	Product code	length code*	Light source	>CRI	CCT**	LED Power	Nominal Lumen	Beam angle (BA°)	Driver Options	Finish
Gola 95 System	<b>G9WI</b>	<b>0568</b>	<b>LED</b>	<b>90</b>	<b>30</b> 3000K	24.4W	4400 lm	EW ( <b>00</b> )	<b>D0</b> No Dim	<b>10</b> ■ Black
Wall	<b>G9WB</b>				<b>40</b> 4000K		4800 lm		<b>DA</b> Dali Dim	<b>11</b> □ White
	<b>G9WS</b>	<b>0848</b>				36.6W	6600 lm		<b>D1</b> 0-10 Dim	<b>75</b> ■ Grey
							7200 lm		<b>DP</b> Phase	
		<b>1128</b>					48.8W	8800 lm	<b>DC</b> CASAMBI	
							9600 lm			
		<b>1408</b>					61W	11000 lm		
							12000 lm			

#### Notes:

\* For complete code ordering information, please see page 253.  
 \*\* For other CCT options, please contact us.  
 For related accessories, please see page 277.  
 EW = Extra Wide. Ordering code: **00**.

# Gola 160 System



Gola 160 System  
Wall

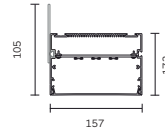

Code ordering example: G1WI05689030000010

	Product code	length code*	Light source	>CRI	CCT**	LED Power	Nominal Lumen	Beam angle (BA°)	Driver Options	Finish
Gola 160 System Wall	<b>G1WI</b>	<b>0568</b>	<b>LED</b>	<b>90</b>	<b>30</b> 3000K	60W	3600 lm	<b>EW (00)</b>	<b>D0</b> No Dim	<b>10</b> ■ Black
	<b>G1WB</b>				<b>40</b> 4000K		3900 lm		<b>DA</b> Dali Dim	<b>11</b> □ White
	<b>G1WS</b>	<b>0848</b>				90W	5400 lm		<b>D1</b> 0-10 Dim	<b>75</b> ■ Grey
							5850 lm		<b>DP</b> Phase	
		<b>1128</b>				120W	7200 lm		<b>DC</b> CASAMBI	
						7800 lm				
	<b>1408</b>				150W	9000 lm				
						9750 lm				

**Notes:**  
 \* For complete code ordering information, please see page 253.  
 \*\* For other CCT options, please contact us.  
 For related accessories, please see page 277.  
 EW = Extra Wide. Ordering code: **00**.

# Gola System Surface Family configuration options

Code ordering example: G4WI05689030000010

## Gola 40 System

Wall | Wall Direct & Indirect

Product code	length code	Light source	>CRI	CCT	LED Power	Nominal Lumen	Beam angle (BA°)	Driver Options	Finish
<b>G4WI</b>	<b>0568</b> 568 mm	<b>LED</b>	<b>90</b>	<b>30</b> 3000K	12.2W	2200 lm	<b>EW (00)</b>	<b>D0</b> No Dim	<b>10</b> ■ Black
<b>G4WB</b>				<b>40</b> 4000K		2400 lm		<b>DA</b> Dali Dim	<b>11</b> □ White
<b>G4WS</b>	<b>0848</b> 848 mm				18.3W	3300 lm		<b>D1</b> 0-10 Dim	<b>75</b> ■ Grey
<b>G4CI</b>						3600 lm		<b>DP</b> Phase	
<b>G4CB</b>	<b>1128</b> 1128 mm				24.4W	4400 lm		<b>DC</b> CASAMBI	
<b>G4CS</b>						4800 lm			
	<b>1408</b> 1408 mm				30.5W	5500 lm			
						6000 lm			

## Gola 60 System

Wall

Product code	length code	Light source	>CRI	CCT	LED Power	Nominal Lumen	Beam angle (BA°)	Driver Options	Finish
<b>G6WI</b>	<b>0568</b> 568 mm	<b>LED</b>	<b>90</b>	<b>30</b> 3000K	12.2W	2200 lm	<b>EW (00)</b>	<b>D0</b> No Dim	<b>10</b> ■ Black
<b>G6WB</b>				<b>40</b> 4000K		2400 lm		<b>DA</b> Dali Dim	<b>11</b> □ White
<b>G6WS</b>	<b>0848</b> 848 mm				18.3W	3300 lm		<b>D1</b> 0-10 Dim	<b>75</b> ■ Grey
						3600 lm		<b>DP</b> Phase	
	<b>1128</b> 1128 mm				24.4W	4400 lm		<b>DC</b> CASAMBI	
						4800 lm			
	<b>1408</b> 1408 mm				30.5W	5500 lm			
						6000 lm			

## Gola 95 System

Wall | Wall Direct & Indirect

Product code	length code	Light source	>CRI	CCT	LED Power	Nominal Lumen	Beam angle (BA°)	Driver Options	Finish
<b>G9WI</b>	<b>0568</b> 568 mm	<b>LED</b>	<b>90</b>	<b>30</b> 3000K	24.4W	4400 lm	<b>EW (00)</b>	<b>D0</b> No Dim	<b>10</b> ■ Black
<b>G9WB</b>				<b>40</b> 4000K		4800 lm		<b>DA</b> Dali Dim	<b>11</b> □ White
<b>G9WS</b>	<b>0848</b> 848 mm				36.6W	6600 lm		<b>D1</b> 0-10 Dim	<b>75</b> ■ Grey
<b>G9CI</b>						7200 lm		<b>DP</b> Phase	
<b>G9CB</b>	<b>1128</b> 1128 mm				48.8W	8800 lm		<b>DC</b> CASAMBI	
<b>G9CS</b>						9600 lm			
	<b>1408</b> 1408 mm				61W	11000 lm			
						12000 lm			

## Gola 160 System

Wall

Product code	length code	Light source	>CRI	CCT	LED Power	Nominal Lumen	Beam angle (BA°)	Driver Options	Finish
<b>G1WI</b>	<b>0568</b> 568 mm	<b>LED</b>	<b>90</b>	<b>30</b> 3000K	36.6W	6600 lm	<b>EW (00)</b>	<b>D0</b> No Dim	<b>10</b> ■ Black
<b>G1WB</b>				<b>40</b> 4000K		7200 lm		<b>DA</b> Dali Dim	<b>11</b> □ White
<b>G1WS</b>	<b>0848</b> 848 mm				54.9W	9900 lm		<b>D1</b> 0-10 Dim	<b>75</b> ■ Grey
						10800 lm		<b>DP</b> Phase	
	<b>1128</b> 1128 mm				73.2W	13200 lm		<b>DC</b> CASAMBI	
						14400 lm			
	<b>1408</b> 1408 mm				91.5W	16500 lm			
						18000 lm			

**Notes:**  
 For other CCT options, please contact us.

# Gola System

40 | 60 | 95 | 160 Ceiling



## Body

Surface mounted linear luminaire system.  
Luminaire housing in extruded aluminium and end caps in cast aluminium.  
Satin white diffuser in extruded UV heat resistant acrylic. End caps are mechanically attached with no exposed fasteners.  
Available in four width apertures (40-60-95-160mm). System versions can be configured into linear I, 90 L, T and X shapes or others custom configurations.

Optional Gimbal light head module with tiltable and routable heads for Gola 95 and 160.

## Accessories

For a complete list of modules and accessories see page 277.

## Finish

Powder coat in black, white and grey colour.

## LED sources

SMD modular system.  
CRI: 90 | CCT: 3000K, 4000K.

Other CRI and CCT options, Tuneable White, DimToWarm and RGB/W versions available on request.

## Optic

Acrylic opal white diffuser.

## Driver

Inclusive of integrated no-dimable driver.  
Dimming Options: 0-10V Dim, DALI, Phase, CASAMBI.

## Applications

Linear system with multiple mounting options to enabling continuous runs of infinite length. It offers the possibility to equipped entire projects with a single product ensuring consistent illumination despite varying ceiling heights  
Application areas: offices, hallways, schools, cafeterias.

## Related Products

**Gola Recessed**  
P. 254



**Gola Wall**  
P. 260



**Gola Pendant**  
P. 270

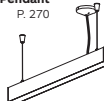

# Gola 40 & 60 System



## Gola 40 System

Ceiling

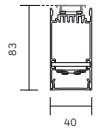

## Gola 60 System

Ceiling

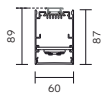

Code ordering example: **G 4 N I 0 5 6 8 - 9 0 3 0 0 0 D 0 1 0**

	Product code	length code*	Light source	>CRI	CCT**	LED Power	Nominal Lumen	Beam angle (BA°)	Driver Options	Finish
Gola 40 System Ceiling	<b>G4NI</b>	<b>0568</b>	<b>LED</b>	<b>90</b>	<b>30</b> 3000K	12.2W	2200 lm	EW ( <b>00</b> )	<b>D0</b> No Dim	<b>10</b> ■ Black
	<b>G4NB</b>				<b>40</b> 4000K		2400 lm		<b>DA</b> Dali Dim	<b>11</b> □ White
	<b>G4NS</b>	<b>0848</b>				18.3W	3300 lm		<b>D1</b> 0-10 Dim	<b>75</b> ■ Grey
Gola 40 System Ceiling	<b>G6NI</b>	<b>1128</b>				24.4W	4400 lm		<b>DP</b> Phase	
	<b>G6NB</b>						4800 lm		<b>DC</b> CASAMBI	
	<b>G6NS</b>	<b>1408</b>				35.5W	5500 lm			
							6000 lm			

### Notes:

\* For complete code ordering information, please see page 253.

\*\* For other CCT options, please contact us.

For related accessories, please see page 277.

EW = Extra Wide. Ordering code: **00**.

# Gola 95 & 160 System



**Gola 95 System**  
Ceiling

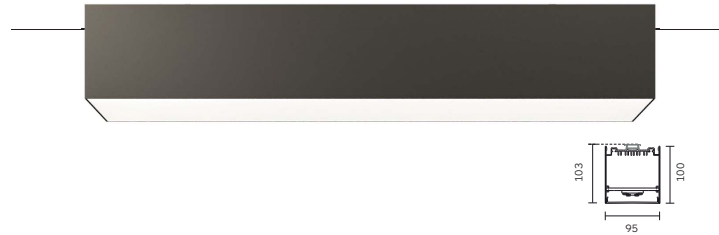

**Gola 160 System**  
Ceiling



Code ordering example: G9N1 0568 90 30 00 D0 10

	Product code	length code*	Light source	>CRI	CCT	LED Power	Nominal Lumen	Beam angle (BA°)	Driver Options	Finish
Gola 95 System Ceiling	<b>G9N1</b>	<b>0568</b>	<b>LED</b>	<b>90</b>	<b>30</b> 3000K	24.4W	4400 lm	EW (00)	<b>D0</b> No Dim	<b>10</b> ■ Black
	<b>G9NB</b>				<b>40</b> 4000K		4800 lm		<b>DA</b> Dali Dim	<b>11</b> □ White
	<b>G9NS</b>	<b>0848</b>				36.6W	6600 lm		<b>D1</b> 0-10 Dim	<b>75</b> ■ Grey
						7200 lm			<b>DP</b> Phase	
		<b>1128</b>				48.8W	8800 lm		<b>DX</b> DMX	
	<b>1408</b>				61W	11000 lm		<b>DC</b> CASAMBI		
Gola 160 System Ceiling	<b>G1N1</b>					36.6W	6600 lm			
	<b>G1NB</b>					7200 lm				
	<b>G1NS</b>					54.9W	9900 lm			
						10800 lm				
						73.2W	13200 lm			
					1400 lm					
					91.5W	16500 lm				
					18000 lm					

**Notes:**  
 \* For complete code ordering information, please see page 253.  
 \*\* For other CCT options, please contact us.  
 For related accessories, please see page 277.  
 EW = Extra Wide. Ordering code: **00**.

# Gola Surface System Family configuration options

Code ordering example: G4N1 0568 90 30 00 D0 10

**Gola 40 System** **Ceiling**

Product code	length code	Light source	>CRI	CCT	LED Power	Nominal Lumen	Beam angle (BA°)	Driver Options	Finish
<b>G4N1</b>	<b>0568</b>	<b>LED</b>	<b>90</b>	<b>30</b> 3000K	12.2W	2200 lm	EW (00)	<b>D0</b> No Dim	<b>10</b> ■ Black
<b>G4NB</b>				<b>40</b> 4000K		2400 lm		<b>DA</b> Dali Dim	<b>11</b> □ White
<b>G4NS</b>	<b>0848</b>				18.3W	3300 lm		<b>D1</b> 0-10 Dim	<b>75</b> ■ Grey
					3600 lm			<b>DP</b> Phase	
	<b>1128</b>				24.4W	4400 lm		<b>DC</b> CASAMBI	
	<b>1408</b>				30.5W	5500 lm			
						6000 lm			

**Gola 60 System** **Ceiling**

Product code	length code	Light source	>CRI	CCT	LED Power	Nominal Lumen	Beam angle (BA°)	Driver Options	Finish
<b>G6N1</b>	<b>0568</b>	<b>LED</b>	<b>90</b>	<b>30</b> 3000K	12.2W	2200 lm	EW (00)	<b>D0</b> No Dim	<b>10</b> ■ Black
<b>G6NB</b>				<b>40</b> 4000K		2400 lm		<b>DA</b> Dali Dim	<b>11</b> □ White
<b>G6NS</b>	<b>0848</b>				18.3W	3300 lm		<b>D1</b> 0-10 Dim	<b>75</b> ■ Grey
					3600 lm			<b>DP</b> Phase	
	<b>1128</b>				24.4W	4400 lm		<b>DC</b> CASAMBI	
	<b>1408</b>				30.5W	5500 lm			
						6000 lm			

**Gola 95 System** **Ceiling**

Product code	length code	Light source	>CRI	CCT	LED Power	Nominal Lumen	Beam angle (BA°)	Driver Options	Finish
<b>G9N1</b>	<b>0568</b>	<b>LED</b>	<b>90</b>	<b>30</b> 3000K	24.4W	4400 lm	EW (00)	<b>D0</b> No Dim	<b>10</b> ■ Black
<b>G9NB</b>				<b>40</b> 4000K		4800 lm		<b>DA</b> Dali Dim	<b>11</b> □ White
<b>G9NS</b>	<b>0848</b>				36.6W	6600 lm		<b>D1</b> 0-10 Dim	<b>75</b> ■ Grey
					7200 lm			<b>DP</b> Phase	
	<b>1128</b>				48.8W	8800 lm		<b>DC</b> CASAMBI	
	<b>1408</b>				61W	11000 lm			
						12000 lm			

**Gola 160 System** **Ceiling**

Product code	length code	Light source	>CRI	CCT	LED Power	Nominal Lumen	Beam angle (BA°)	Driver Options	Finish
<b>G1N1</b>	<b>0568</b>	<b>LED</b>	<b>90</b>	<b>30</b> 3000K	36.6W	6600 lm	EW (00)	<b>D0</b> No Dim	<b>10</b> ■ Black
<b>G1NB</b>				<b>40</b> 4000K		7200 lm		<b>DA</b> Dali Dim	<b>11</b> □ White
<b>G1NS</b>	<b>0848</b>				54.9W	9900 lm		<b>D1</b> 0-10 Dim	<b>75</b> ■ Grey
					10800 lm			<b>DP</b> Phase	
	<b>1128</b>				73.2W	13200 lm		<b>DC</b> CASAMBI	
	<b>1408</b>				91.5W	16500 lm			
						18000 lm			

**Notes:**  
 For other CCT options, please contact us.

# Gola System

40 | 60 | 95 | 160 Pendant



## Body

Pendant linear luminaire system.  
Luminaire housing in extruded aluminium and end caps in cast aluminium. Satin white diffuser in extruded UV heat resistant acrylic.  
End caps are mechanically attached with no exposed fasteners.  
Cable and stainless steel adjustable suspension wires with canopy included and ready for electrical connection.

Available in four width apertures (40-60-95-160mm).  
Direct, direct/indirect and indirect light options available.  
Optional Gimbal light head module with tiltable and rotatable heads for Gola 95 and 160.

## Accessories

For a complete list of modules and accessories see page 277.

## Finish

Powder coat in black, white and grey colour.

## LED sources

SMD modular system.  
CRI: 90 | CCT: 3000K, 4000K.

Other CRI and CCT options, Tuneable White, DimToWarm and RGB/W versions available on request.

## Optic

Acrylic opal white diffuser.

## Driver

Inclusive of integrated no-dimable driver.  
Dimming Options: 0-10V Dim, DALI, Phase, CASAMBI.

## Applications

Linear system with multiple mounting options to enabling continuous runs of infinite length. It offers the possibility to equipped entire projects with a single product ensuring consistent illumination despite varying ceiling heights  
Application areas: offices, hallways, schools, cafeterias.

## Related Products

**Gola Recessed**  
P. 254



**Gola Wall**  
P. 260



**Gola Ceiling**  
P. 266



## Gola 40 System

### Gola 40 System

Pendant

### Gola 40 System

Pendant Direct & Indirect

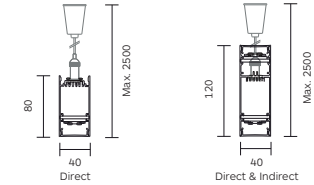

Code ordering example: **G 4 P | 0 5 6 8 - 9 0 3 0 0 0 D 0 1 0**

	Product code	length code*	Light source	>CRI	CCT**	LED Power	Nominal Lumen	Beam angle (BA°)	Driver Options	Finish
Gola 40 System Pendant	<b>G4PI</b>	<b>0568</b>	<b>LED</b>	<b>90</b>	<b>30</b> 3000K	12.2W	2200 lm	EW ( <b>00</b> )	<b>D0</b> No Dim	<b>10</b> ■ Black
	<b>G4PB</b>				<b>40</b> 4000K		2400 lm		<b>DA</b> Dali Dim	<b>11</b> □ White
	<b>G4PS</b>	<b>0848</b>				18.3W	3300 lm		<b>D1</b> 0-10 Dim	<b>75</b> ■ Grey
Gola 40 System Pendant Direct & Indirect							3600 lm		<b>DP</b> Phase	
	<b>G4UI</b>	<b>1128</b>				24.4W	4400 lm		<b>DC</b> CASAMBI	
	<b>G4UB</b>						4800 lm			
	<b>G4US</b>	<b>1408</b>				30.5W	5500 lm			
							6000 lm			

### Notes:

\* For complete code ordering information, please see page 253.

\*\* For other CCT options, please contact us.

For related accessories, please see page 277.

EW = Extra Wide. Ordering code: **00**.



## Gola 60 System

**Gola 60 System**  
Pendant

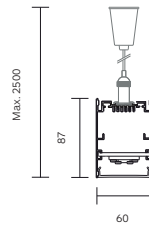
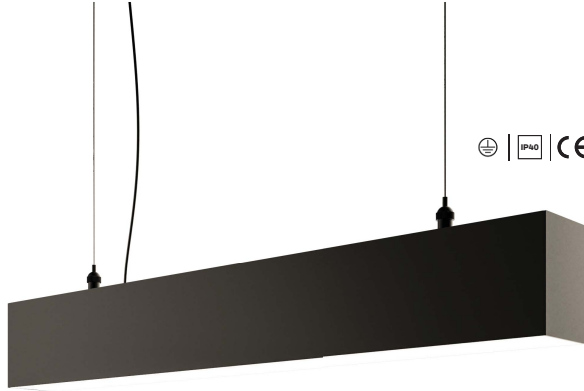

Code ordering example: **G 6 P I 0 5 6 8 - 9 0 3 0 0 0 D 0 1 0**

	Product code	length code*	Light source	>CRI	CCT**	LED Power	Nominal Lumen	Beam angle (BA°)	Driver Options	Finish
Gola 60 System Pendant	<b>G6PI</b>	<b>0568</b>	<b>LED</b>	<b>90</b>	<b>30</b> 3000K	12.2W	2200 lm	<b>EW (00)</b>	<b>D0</b> No Dim	<b>10</b> ■ Black
					<b>40</b> 4000K	2400 lm	<b>DA</b> Dali Dim	<b>11</b> □ White		
	<b>G6PB</b>	<b>0848</b>				18.3W	3300 lm		<b>D1</b> 0-10 Dim	<b>75</b> ■ Grey
							3600 lm		<b>DP</b> Phase	
		<b>1128</b>				24.4W	4400 lm		<b>DC</b> CASAMBI	
	<b>1408</b>					4800 lm				
						30.5W	5500 lm			
							6000 lm			

**Notes:**

\* For complete code ordering information, please see page 253.  
\*\* For other CCT options, please contact us.  
For related accessories, please see page 277.  
EW = Extra Wide. Ordering code: **00**.

## Gola 95 System

**Gola 95 System**  
Pendant

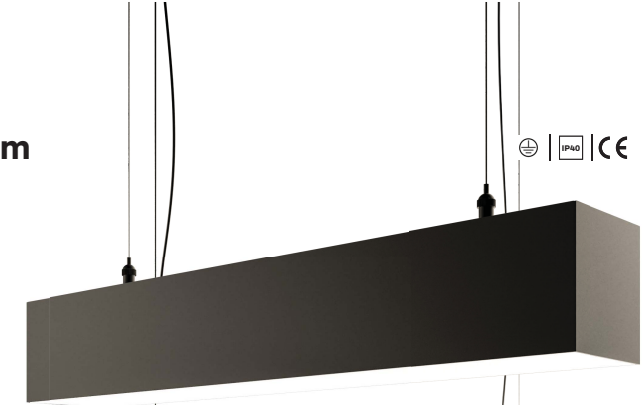

**Gola 95 System**  
Pendant Direct & Indirect

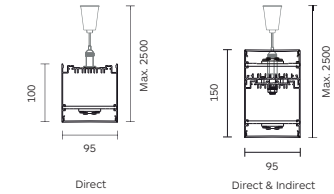

Code ordering example: **G 9 P I 0 5 6 8 - 9 0 3 0 0 0 D 0 1 0**

	Product code	length code*	Light source	>CRI	CCT**	LED Power	Nominal Lumen	Beam angle (BA°)	Driver Options	Finish
Gola 95 System Pendant	<b>G9PI</b>	<b>0568</b>	<b>LED</b>	<b>90</b>	<b>30</b> 3000K	24.4W	4400 lm	<b>EW (00)</b>	<b>D0</b> No Dim	<b>10</b> ■ Black
					<b>40</b> 4000K	4800 lm	<b>DA</b> Dali Dim	<b>11</b> □ White		
	<b>G9PB</b>	<b>0848</b>				36.6W	6600 lm		<b>D1</b> 0-10 Dim	<b>75</b> ■ Grey
						7200 lm		<b>DP</b> Phase		
Gola 95 System Pendant	<b>G9UI</b>	<b>1128</b>				48.8W	8800 lm		<b>DC</b> CASAMBI	
Direct & Indirect	<b>G9UB</b>						9600 lm			
							61W	11000 lm		
	<b>G9US</b>	<b>1408</b>					12000 lm			

**Notes:**

\* For complete code ordering information, please see page 253.  
\*\* For other CCT options, please contact us.  
For related accessories, please see page 277.  
EW = Extra Wide. Ordering code: **00**.

# Gola 160 System

Gola 160 System  
Pendant

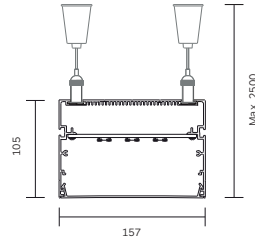
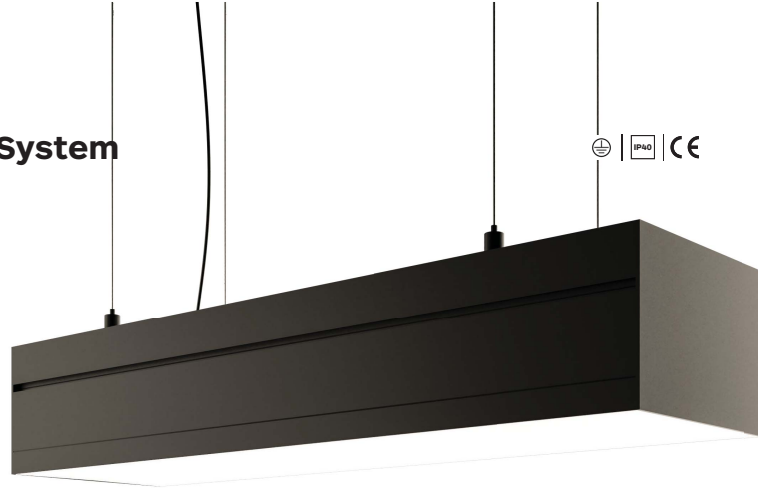

Code ordering example: G1PI05689030000D010

	Product code	length code*	Light source	>CRI	CCT**	LED Power	Nominal Lumen	Beam angle (BA°)	Driver Options	Finish
Gola 160 System Pendant	<b>G1PI</b>	<b>0568</b>	<b>LED</b>	<b>90</b>	<b>30</b> 3000K	36.6W	6600 lm	<b>EW (00)</b>	<b>DO</b> No Dim	<b>10</b> ■ Black
	<b>G1PB</b>				<b>40</b> 4000K		7200 lm		<b>DA</b> Dali Dim	<b>11</b> □ White
	<b>G1PS</b>	<b>0848</b>				54.9W	9900 lm		<b>D1</b> 0-10 Dim	<b>75</b> ■ Grey
							10800 lm		<b>DP</b> Phase	
		<b>1128</b>				73.2W	13200 lm		<b>DC</b> CASAMBI	
						14400 lm				
	<b>1408</b>				91.5W	16500 lm				
						18000 lm				

**Notes:**  
 \* For complete code ordering information, please see page 253.  
 \*\* For other CCT options, please contact us.  
 For related accessories, please see page 277.  
 EW = Extra Wide. Ordering code: **00**.

# Gola System Pendant Family configuration options

Code ordering example: G4PI05689030000D010

## Gola 40 System

Pendant | Pendant Direct & Indirect

Product code	length code	Light source	>CRI	CCT	LED Power	Nominal Lumen	Beam angle (BA°)	Driver Options	Finish
<b>G4PI</b>	<b>0568</b> 568 mm	<b>LED</b>	<b>90</b>	<b>30</b> 3000K	12.2W	2200 lm	<b>EW (00)</b>	<b>DO</b> No Dim	<b>10</b> ■ Black
<b>G4PB</b>				<b>40</b> 4000K		2400 lm		<b>DA</b> Dali Dim	<b>11</b> □ White
<b>G4PS</b>	<b>0848</b> 848 mm				18.3W	3300 lm		<b>D1</b> 0-10 Dim	<b>75</b> ■ Grey
<b>G4US</b>						3600 lm		<b>DP</b> Phase	
<b>G4UI</b>	<b>1128</b> 1128 mm				24.4W	4400 lm		<b>DC</b> CASAMBI	
<b>G4UB</b>						4800 lm			
	<b>1408</b> 1408 mm				30.5W	5500 lm			
						6000 lm			

## Gola 60 System

Pendant

Product code	length code	Light source	>CRI	CCT	LED Power	Nominal Lumen	Beam angle (BA°)	Driver Options	Finish
<b>G6PI</b>	<b>0568</b> 568 mm	<b>LED</b>	<b>90</b>	<b>30</b> 3000K	12.2W	2200 lm	<b>EW (00)</b>	<b>DO</b> No Dim	<b>10</b> ■ Black
<b>G6PB</b>				<b>40</b> 4000K		2400 lm		<b>DA</b> Dali Dim	<b>11</b> □ White
<b>G6PS</b>	<b>0848</b> 848 mm				18.3W	3300 lm		<b>D1</b> 0-10 Dim	<b>75</b> ■ Grey
						3600 lm		<b>DP</b> Phase	
	<b>1128</b> 1128 mm				24.4W	4400 lm		<b>DC</b> CASAMBI	
						4800 lm			
	<b>1408</b> 1408 mm				30.5W	5500 lm			
						6000 lm			

## Gola 95 System

Pendant | Pendant Direct & Indirect

Product code	length code	Light source	>CRI	CCT	LED Power	Nominal Lumen	Beam angle (BA°)	Driver Options	Finish
<b>G9PS</b>	<b>0568</b> 568 mm	<b>LED</b>	<b>90</b>	<b>30</b> 3000K	24.4W	4400 lm	<b>EW (00)</b>	<b>DO</b> No Dim	<b>10</b> ■ Black
<b>G9PB</b>				<b>40</b> 4000K		4800 lm		<b>DA</b> Dali Dim	<b>11</b> □ White
<b>G9PI</b>	<b>0848</b> 848 mm				36.6W	6600 lm		<b>D1</b> 0-10 Dim	<b>75</b> ■ Grey
<b>G9UI</b>						7200 lm		<b>DP</b> Phase	
<b>G9US</b>	<b>1128</b> 1128 mm				48.8W	8800 lm		<b>DC</b> CASAMBI	
<b>G9UB</b>						9600 lm			
	<b>1408</b> 1408 mm				61W	11000 lm			
						12000 lm			

## Gola 160 System

Pendant

Product code	length code	Light source	>CRI	CCT	LED Power	Nominal Lumen	Beam angle (BA°)	Driver Options	Finish
<b>G1PI</b>	<b>0568</b> 568 mm	<b>LED</b>	<b>90</b>	<b>30</b> 3000K	36.6W	6600 lm	<b>EW (00)</b>	<b>DO</b> No Dim	<b>10</b> ■ Black
<b>G1PB</b>				<b>40</b> 4000K		7200 lm		<b>DA</b> Dali Dim	<b>11</b> □ White
<b>G1PS</b>	<b>0848</b> 848 mm				54.9W	9900 lm		<b>D1</b> 0-10 Dim	<b>75</b> ■ Grey
						10800 lm		<b>DP</b> Phase	
	<b>1128</b> 1128 mm				73.2W	13200 lm		<b>DC</b> CASAMBI	
						14400 lm			
	<b>1408</b> 1408 mm				91.5W	16500 lm			
						18000 lm			

**Notes:**  
 For other CCT options, please contact us.

# System Connections

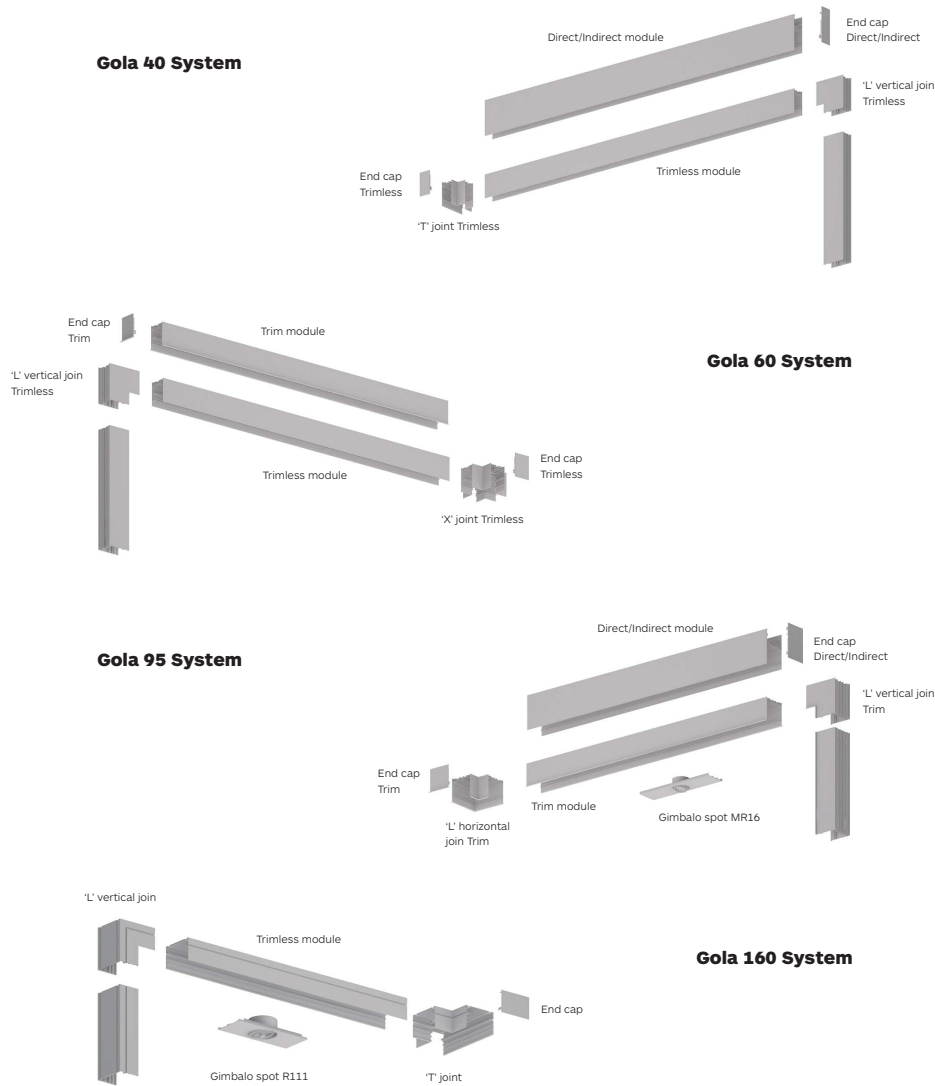

# Accessories

Accessories / Product	Gola 40 System	Gola 60 System	Gola 95 System	Gola 160 System	Gola Zero	Finish
End Cap Trim In cast aluminium	<b>G040ECF</b> 	<b>G060ECF</b> 	<b>G095ECF</b> 	\	<b>G040ECF</b> 	Colours 10 11 75
End Cap Trimless In cast aluminium	<b>G040ECM</b> 	<b>G060ECM</b> 	<b>G095ECM</b> 	<b>G160ECM</b> 	<b>G040ECM</b> 	
End Cap Direct/Indirect In cast aluminium	<b>G040ECU</b> 	\	<b>G095ECU</b> 	\	\	
L' Horizontal Joint For Trim version In extruded aluminium	<b>G040FLHJ</b> 	<b>G060FLHJ</b> 	<b>G095FLHJ</b> 	\	\	
L' Vertical Joint For Trim version In extruded aluminium	<b>G040FLVJ</b> 	<b>G060FLVJ</b> 	<b>G095FLVJ</b> 	\	\	
L' Horizontal Joint For Trimless version In extruded aluminium	<b>G040MLHJ</b> 	<b>G060MLHJ</b> 	<b>G095MLHJ</b> 	<b>G160MLHJ</b> 	\	
L' Vertical Joint For Trimless version In extruded aluminium	<b>G040MLVJ</b> 	<b>G060MLVJ</b> 	<b>G095MLVJ</b> 	<b>G160MLVJ</b> 	\	
T' 3 - way Joint For Trim version In extruded aluminium	<b>G040FT3J</b> 	<b>G060FT3J</b> 	<b>G095FT3J</b> 	\	\	
T' 3 - way Joint For Trimless version In extruded aluminium	<b>G040MT3J</b> 	<b>G060MT3J</b> 	<b>G095MT3J</b> 	<b>G160MT3J</b> 	\	
X' 4 - way Joint For Trim version In extruded aluminium	<b>G040FX4J</b> 	<b>G060FX4J</b> 	<b>G095FX4J</b> 	\	\	
X' 4 - way Joint For Trimless version In extruded aluminium	<b>G040MX4J</b> 	<b>G060MX4J</b> 	<b>G095MX4J</b> 	<b>G160MX4J</b> 	\	
Cover In extruded aluminium	<b>G040C</b> 	<b>G060C</b> 	<b>G095C</b> 	<b>G160C</b> 	<b>G040C</b> 	
Suspension Kit Max. 2500 mm	<b>GSUS</b> 	<b>GSUS</b> 	<b>GSUS</b> 	<b>GSUS</b> 	\	
Electrical Supply Kit Max. 2500 mm	<b>GELS</b> 	<b>GELS</b> 	<b>GELS</b> 	<b>GELS</b> 	\	
Opal Diffuser Max. 4000 mm	<b>G040D</b>	<b>G060D</b>	<b>G095D</b>	<b>G160D</b>	\	Colour 40

**Notes:**

For complete code ordering information, please see page 377.



# **You design it, We make it happen**

We create the project according to your space needs and dimensions

# Infito

Ceiling, wall and in-ground floor mounted System



## Body

Architectural recessed modular solution with body in injection moulded polycarbonate inclusive of a stainless steel edge and a diffuser.

Different model available for ceiling, wall and in-ground floor mounting.

Ceiling/wall version diffuser made of thick opal acrylic, floor version made of a toughened thermal-shock glass.

The different module are easy to interlock and create infinite shapes.

## LED sources

No light source provided.  
Led strip in different colour temperature, Tuneable White, RGB/W available on request.

## Optic

white acrylic or glass difuser.

## Accessories

IP68 Fast Connector, IP67 Waterproof box, Electrical Power Supply.

## Finish

Powder coat in opal whitecolour.

## Driver

Driver not included to be order separatly.

## Applications





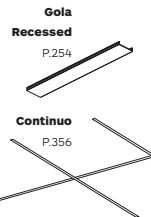

The patterns and arrangements of the Infito system are limitless. This elegant product can be integrated into an infinite number of different architectural applications. Application areas: staircases, floors, gardens, restaurants, casinos, cruise ships, hotels "Infinite" applications.

## Related Products



# Infito

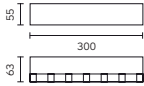
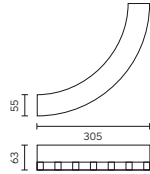

Infito Straight		Infito Curve		End Cap	LED Flex Ribbon Strip
					
Floor	Ceiling	Floor	Ceiling		
<b>8361</b>	<b>8362</b>	<b>8363</b>	<b>8364</b>	<b>8373</b>	<b>4268</b>
Straight Plastic casing with glass diffuser.	Straight Plastic casing with PMMA plastic diffuser.	Curve Plastic casing with glass diffuser.	Curve Plastic casing with PMMA plastic diffuser.	Available in colour 11. One for each free end.	Length based on profile design. Available in 3000K and 4000K.
					Other colour temperatures K are available upon request.  LED strip minimum cutting unit: 100 mm.  End caps not included. To be ordered separately.  Passive dissipation driver not included. 24V DC operation, 12W/meter.
LED Flex Ribbon Strip not included. To be ordered separately.					

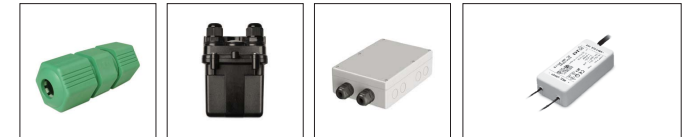

Product / Accessories	Fast Connector M20	Waterproof box	Waterproof box	Electronic Power Supply	
	IP68	IP67 with PG9 cable glands Colour 10	IP67 with PG9 cable glands	36W A:40 / B:148 / C:30	60W A:43 / B:163 / C:32
<b>Infito System</b>	<b>2577</b>	<b>2494</b>	<b>2495</b>	<b>2200</b>	<b>2201</b>
	⌀ 6 + 12 mm)	Electronic power supply not included, to be ordered separately. Dimensions: 81 x 69 x h116 mm.	Electronic power supply not included, to be ordered separately. Dimensions: 207 x 125 x h61 mm.	For LED strip support of a length: Max. 3m.	For LED Strip support of a length: Max. 5m. Input 220-240V 50/60Hz. Output 24V DC.

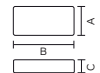

## Notes:

For complete code ordering information, please see page 377.

# Ala

## System Pendant & Surface



## Body

Ala is an elegant modular lighting system with luminaire body in extruded aluminium, end caps in cast aluminium inclusive of concealed fasteners.

Satinized or prismatic white diffuser in extruded acrylic.

Pendant version is supplied with pre-installed 1.5m electrical cable and suspension adjustable cables.

Surface mounted is supplied with wall bracket. All versions are available in both direct and direct/indirect emission.

## Accessories

No accessories available.

## Finish

Powder coat in white colour.

## LED sources

Lexar SMD Series.  
CRI: 90 | CCT: 3000K, 4000K.

Other CRI and CCT options available on request.

## Optic

White acrylic diffuser.

## Driver

Inclusive of integrated no-dimable driver.  
Dimming Options: 0-10V Dim, DALI, Phase, CASAMBI.

## Applications

High quality design and intelligent engineering delivers a balanced pleasant light directly to the work space that increases visual, the ideal solution to provide well-being and productivity in the office. Application areas: offices, workstations, schools, conference rooms.

## Related Products

**Gola Wall**  
P. 260



**Gola Pendant**  
P. 270

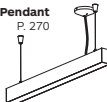

**Miniluce Surface**  
P. 202



**Miniluce Pendant**  
P. 236

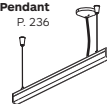

# Ala Pendant



**Ala**  
Up & Down

**Ala**  
Down & Up

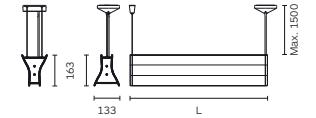

Code ordering example: **7 2 4 3 0 8 9 0 - 9 0 3 0 0 0 D 0 1 1**

	Product code	length code*	Light source	>CRI	CCT**	LED Power		Nominal Lumen		Beam angle (BA°)	Driver Options	Finish	
						Up	Down	Up	Down				
Ala Pendant Up & Down	<b>7243</b>	<b>0890</b>	<b>LED</b>	<b>90</b>	<b>30</b>	<b>3000K</b>	38W	13W	4219 lm	1406 lm	<b>EW (00)</b>	<b>D0</b> No Dim	<b>11</b> White
							40	4000K	4571 lm	1524 lm			
	<b>7244</b>	<b>1140</b>	49.5W	16.5W	5460 lm	1820 lm	<b>DA</b> Dali Dim	<b>D1</b> 0-10 Dim					
			5915 lm	1972 lm	<b>DP</b> Phase								
<b>7245</b>	<b>1740</b>	76.5W	25.5W	8438 lm		2813 lm	<b>DC</b> CASAMBI						
		9141 lm	3047 lm										
Ala Pendant Down & Up	<b>7249</b>	<b>0890</b>	13W	38W	1406 lm	4219 lm	<b>DA</b> Dali Dim	<b>D1</b> 0-10 Dim					
			1524 lm	4571 lm									
	<b>7250</b>	<b>1140</b>	16.5W	49.5W	1820 lm	5460 lm	<b>DP</b> Phase						
			1972 lm	5915 lm									
<b>7251</b>	<b>1740</b>	25.5W	76.5W	2813 lm	8438 lm	<b>DC</b> CASAMBI							
		3047 lm	9141 lm										

### Notes:

\* For complete code ordering information, please see page 377.

\*\* For other CCT options, please contact us.

EW = Extra Wide. Ordering code: **00**.

## Ala Pendant

**Ala**  
Up light

**Ala**  
Down light

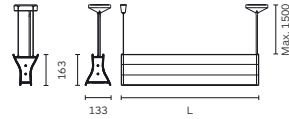

Code ordering example: 7246 0890 90 30 00 D0 11

	Product code	length code*	Light source	>CRI	CCT**	LED Power		Nominal Lumen		Beam angle (BA°)	Driver Options	Finish
						Up	Down	Up	Down			
Ala Pendant Up light	<b>7246</b>	<b>0890</b>	<b>LED</b>	<b>90</b>	<b>30</b>	3000K	38W	4219lm	EW (00)	<b>DO</b>	No Dim	<b>11</b> L White
						4000K	49.5W	5460lm	<b>DA</b>	Dali Dim		
	<b>7247</b>	<b>1140</b>	4000K	49.5W	5460lm	<b>D1</b>	0-10 Dim					
			4000K	76.5W	8438 lm	<b>DP</b>	Phase					
Ala Pendant Down light	<b>7252</b>	<b>0890</b>	<b>LED</b>	<b>90</b>	<b>30</b>	3000K	38W	4219 lm				
						4000K	49.5W	5460 lm				
	<b>7253</b>	<b>1140</b>	4000K	49.5W	5460 lm							
			4000K	76.5W	8438 lm							

**Notes:**

\* For complete code ordering information, please see page 377.  
\*\* For other CCT options, please contact us.  
EW = Extra Wide. Ordering code: **00**.

## Ala Surface

**Ala**  
Up & Down

**Ala**  
Down & Up

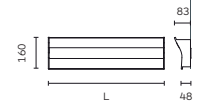

Code ordering example: 1371 0610 90 30 00 D0 11

	Product code	length code*	Light source	>CRI	CCT**	LED Power		Nominal Lumen		Beam angle (BA°)	Driver Options	Finish		
						Up	Down	Up	Down					
Ala Surface	<b>1371</b>	<b>0610</b>	<b>LED</b>	<b>90</b>	<b>30</b>	3000K	16.8W	8.4W	1985 lm	993 lm	EW (00)	<b>DO</b>	No Dim	<b>11</b> L White
						4000K	25.2W	12.6W	2151 lm	1075 lm	<b>DA</b>	Dali Dim		
	<b>1372</b>	<b>0910</b>	4000K	25.2W	12.6W	2978 lm	1489 lm	<b>D1</b>	0-10 Dim					
			4000K	33.6W	16.8W	3224 lm	1614 lm	<b>DP</b>	Phase					
Ala Surface	<b>1373</b>	<b>1210</b>	<b>LED</b>	<b>90</b>	<b>30</b>	3000K	33.6W	16.8W	3971 lm	1985 lm		<b>DC</b>	CASAMBI	
						4000K	42W	21W	4302 lm	2151 lm				
	<b>1374</b>	<b>1510</b>	4000K	42W	21W	4964 lm	2482 lm							
			4000K	53.7W	26.8W	5377 lm	2689 lm							

**Notes:**

\* For complete code ordering information, please see page 377.  
\*\* For other CCT options, please contact us.  
EW = Extra Wide. Ordering code: **00**.

# Canali

EdgeForms System

Channel 200 mm

Side-Mount Light Unit

Trimless

## Body

All channel parts in extruded aluminium. Luminaire spot body in cast aluminium, luminaire connection arm in extruded aluminium.

Clean, unobtrusive trimless installation with above-ceiling suspension. Easy modular structure with 150mm, 200mm and 90° "L" unit.

The system is completed by traverse set, end set and end cover plate. 3 circuit track mounted inside the channel. Spotlight units are mounted on the top or side of channel interior.

Possibility to upgrade the system after the installation adding fixtures or circuits.

## Accessories

Accommodation modules for: fire sprinklers, surveillance camera, HVAC diffuser, speakers, WiFi access point available upon request.

## Finish

Powder coat in black colour.

## LED sources

For light source data refer to the single spotlight technical information.

## Optic

Lens or reflector, according with the single spotlight technical information.

## Driver

Driver not included or integrated, according with the chosen spotlight. Different diming options available on request.

## Applications

A comprehensive range of trimless multi-directional display lighting system available in wide variety of sizes and configurations, using a wide option of lamp types. Application areas: retail, museums, galleries, exhibits, jewelry shops, residential, lift lobbies.

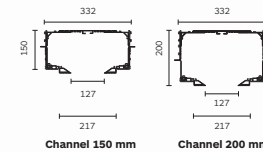
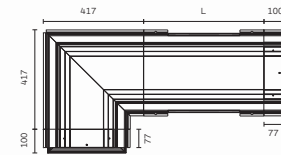
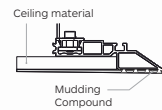

Code	High (H)	Length (L)	Image
Channel 8130	150	500	
8131	1000	2000	
8132	2000	2000	
Channel 8133	200		
8134			
8135			

Traverse set included. In extruded aluminium.

Open Channel or with optional track installed

Traverse Set	Code	High (H)	Length (L)	Image
	8101	500	1000	
	8102	1000	2000	
	8103	2000	3000	
	8104	3000	3000	

In extruded aluminium. Pair.

Ends set	Code	Image
	8105	
	End cover	

Channel 150 mm

Fire Sprinkler Module

'L' Shape Module

Top-Mount Light Unit



Code	High (H)	Length (L)	Image	Code	High (H)	Length (L)	Image
L' Shape Joint 8110	150	500		L' Shape Joint 8115	150	1000	
	200	2000					
Traverse set included. In extruded aluminium.				End cover plate 8136	150	1000	
				8137	200	2000	
In extruded aluminium. Pair.				In extruded aluminium. Pair. Includes Art. 8105.			

Camera module, HVAC Diffuser module and PA Speaker module, available upon request.



## Canali Side Mounted

IP20 CE

### Canali Micro Gimbal

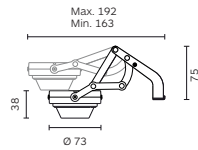
Side mounted 

### Canali Gimbal

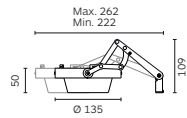
Side mounted 

### Canali Zero 66

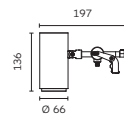
Side mounted Code ordering example **8 3 0 1 G U 5 3 - 0 0 0 0 0 0 D 0 1 0**

	Product code	Light source code	>CRI	CCT**	LED power	Nominal lumen	Beam angle (BA°)	Driver Options	Finish
Canali Micro Gimbal	<b>8301</b>	<b>GU53</b> Retrofit MR16-GU5.3	<b>00</b>	<b>00</b>	\	\	<b>00</b>	<b>D0</b> No Dim	<b>10</b> ■ Black
Canali Gimbal	<b>8303</b>	<b>AR11</b> AR111	<b>00</b>	<b>00</b>	\	\	<b>00</b>		
Canali Zero 66	<b>8370</b>	<b>BC22</b> Citizen COB	<b>90</b>	<b>30</b> 3000K <b>40</b> 4000K	22W	2422 lm 2577 lm	<b>16 / 30 / 60</b>	<b>D0</b> No Dim <b>DA</b> Dali Dim <b>DP</b> Phase Dim <b>DC</b> CASAMBI <b>D1</b> 1-10V Dim	

#### Notes:

\* For complete code ordering information, please see page 377.  
 \*\* For other CCT options, please contact us.  
 Transformer and driver are not included. To be ordered separately.

## Canali Top Mounted

IP20 CE

### Canali Mini Swinger

Top mounted

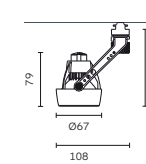

### Canali Micro Conos

Top mounted

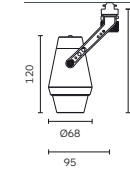
Code ordering example **8 3 0 7 G U 5 3 - 0 0 0 0 0 0 D 0 1 0**

	Product code	Light source code*	>CRI	CCT**	LED power	Nominal lumen	Beam angle (BA°)	Driver Options	Finish
Canali Mini Swinger	<b>8307</b>	<b>GU53</b> Retrofit MR16-GU5.3	<b>00</b>	<b>00</b>	\	\	<b>00</b>	<b>D0</b> No Dim	<b>10</b> ■ Black
Canali Micro Conos	<b>8309</b>	<b>AR11</b> AR111	<b>00</b>	<b>00</b>	\	\	<b>00</b>		

#### Notes:

\* For complete code ordering information, please see page 377.  
 \*\* For other CCT options, please contact us.  
 Transformer not included. To be ordered separately.  
 For channel height 150 mm only.



<“Light and the rational forms are locked in combat; light sets them into motion, bends what is straight, makes parallels oval, inscribes circles in the intervals, makes the intervals active”>.

Paul Klee

# Guideline



## Aluminium Linear Profile System

Guideline 1	Guideline 2	Guideline 3	Guideline 4
<b>8390</b>	<b>8391</b>	<b>8392</b>	<b>8393</b>
Recessed linear profile in extruded aluminium inclusive of opal diffuser. Installation spring clip and end caps in cast aluminium included. CRI: 90, CCT: 3000K, 4000K. Other CRI/CCT, TuneableWhite and RGB/W versions available on request. No driver included to be order separately. Application areas: residential, hospitality, retail.	Cove light linear profile in extruded aluminium inclusive of opal diffuser. Installation bracket and end caps in cast aluminium included. CRI: 90, CCT: 3000K, 4000K. Other CRI/CCT, TuneableWhite and RGB/W versions available on request. No driver included to be order separately. Application areas: residential, hospitality, retail.	Cove light linear profile in extruded aluminium inclusive of opal diffuser. Installation bracket and end caps in cast aluminium included. CRI: 90, CCT: 3000K, 4000K. Other CRI/CCT, TuneableWhite and RGB/W versions available on request. No driver included to be order separately. Application areas: residential, hospitality, retail.	Recessed linear profile in extruded aluminium inclusive of opal diffuser. Installation bracket and end caps in cast aluminium included. CRI: 90, CCT: 3000K, 4000K. Other CRI/CCT, TuneableWhite and RGB/W versions available on request. No driver included to be order separately. Application areas: residential, hospitality, retail.

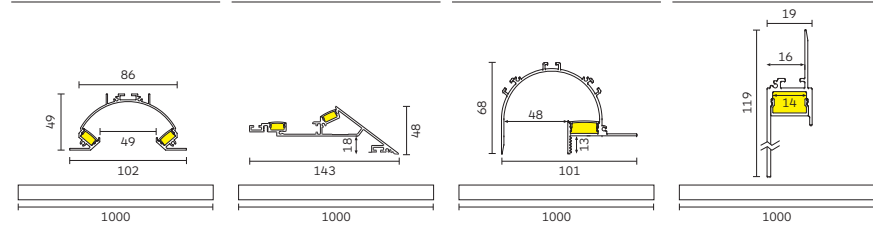

Code ordering example: **8 3 9 0 1 0 0 0 - 9 0 3 0 0 0 0 7 9**

	Product Code	Length Code*	>CRI	CCT**	LED Power	Nominal Lumen	Beam Angle (BA°)	Driver Options	Finish
Guideline 1	<b>8390</b>	<b>1000</b> 1000mm	<b>90</b>	<b>30</b> 3000K <b>40</b> 4000K	2x22W	3600 lm	EW (00)	<b>00</b> No Driver <b>D0</b> No Dim <b>DA</b> Dali Dim <b>DP</b> Phase Dim	<b>79</b> Aluminium
Guideline 2	<b>8391</b>							<b>DC</b> CASAMBI <b>D1</b> 0-10V Dim	
Guideline 3	<b>8392</b>				22W	1800 lm			
Guideline 4	<b>8393</b>								

**Notes:**  
 \* For complete code ordering information, please see page 377.  
 \*\* For other CCT options, please contact us.  
 EW = Extra Wide. Ordering code: **00**.

Guideline 5	Guideline 6	Guideline 7	Guideline 8
<b>8394</b>	<b>8395</b>	<b>8396</b>	<b>8397</b>
Recessed linear profile in extruded aluminium inclusive of opal diffuser. Installation bracket and end caps in cast aluminium included. CRI: 90, CCT: 3000K, 4000K. Other CRI/CCT, TuneableWhite and RGB/W versions available on request. No driver included to be order separately. Application areas: residential, hospitality, retail.	Corner recessed linear profile in extruded aluminium inclusive of opal diffuser. Installation bracket and end caps in cast aluminium included. CRI: 90, CCT: 3000K, 4000K. Other CRI/CCT, TuneableWhite and RGB/W versions available on request. No driver included to be order separately. Application areas: residential, hospitality, retail.	Corner recessed linear profile in extruded aluminium inclusive of opal diffuser. Installation bracket and end caps in cast aluminium included. CRI: 90, CCT: 3000K, 4000K. Other CRI/CCT, TuneableWhite and RGB/W versions available on request. No driver included to be order separately. Application areas: residential, hospitality, retail.	Corner recessed linear profile in extruded aluminium inclusive of opal diffuser. Installation bracket and end caps in cast aluminium included. CRI: 90, CCT: 3000K, 4000K. Other CRI/CCT, TuneableWhite and RGB/W versions available on request. No driver included to be order separately. Application areas: residential, hospitality, retail.

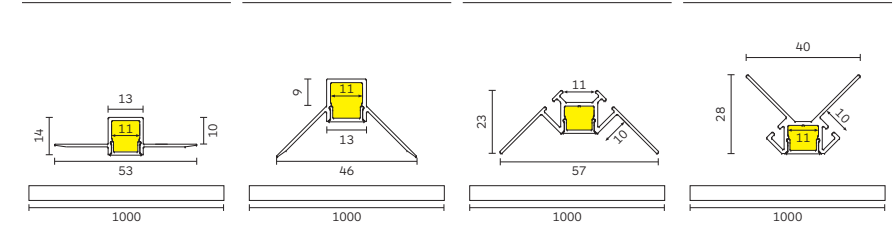

Code ordering example: **8 3 9 4 1 0 0 0 - 9 0 3 0 0 0 0 7 9**

	Product Code	Length Code*	>CRI	CCT**	LED Power	Nominal Lumen	Beam Angle (BA°)	Driver Options	Finish
Guideline 5	<b>8394</b>	<b>1000</b> 1000mm	<b>90</b>	<b>30</b> 3000K <b>40</b> 4000K	22W	1800 lm	EW (00)	<b>00</b> No Driver <b>D0</b> No Dim <b>DA</b> Dali Dim <b>DP</b> Phase Dim	<b>79</b> Aluminium
Guideline 6	<b>8395</b>							<b>DC</b> CASAMBI <b>D1</b> 0-10V Dim	
Guideline 7	<b>8396</b>								
Guideline 8	<b>8397</b>								

**Notes:**  
 \* For complete code ordering information, please see page 377.  
 \*\* For other CCT options, please contact us.  
 EW = Extra Wide. Ordering code: **00**.

## Guideline Family configuration options

Code ordering example: 8390 - 0500 - 903000079

### Guideline

### System

Product code	length code* length	Light source	>CRI	CCT**	LED Power	Nominal Lumen	Beam angle (BA°)	Driver Options	Finish
<b>8390</b>	<b>0500</b> 500 mm	<b>LED</b>	<b>90</b>	<b>30</b> 3000K	2x11W	1800 lm	EW ( <b>00</b> )	<b>00</b> No Driver	<b>79</b> Aluminium
<b>8391</b>	<b>1000</b> 1000 mm			<b>40</b> 4000K	2x22W	3600 lm		<b>D0</b> No Dim	
	<b>1500</b> 1500 mm				2x33W	5400 lm		<b>DA</b> Dali Dim	
	<b>2000</b> 2000 mm				2x44W	7200 lm		<b>DP</b> Phase Dim	
	<b>3000</b> 3000 mm				2x66W	10800 lm		<b>DC</b> CASAMBI	
	<b>9000</b> 9000 mm				2x198W	32400 lm		<b>D1</b> 0-10V Dim	
<b>8392</b>	<b>0500</b> 500 mm				11W	900 lm			
<b>8393</b>	<b>1000</b> 1000 mm				22W	1800 lm			
<b>8394</b>	<b>1500</b> 1500 mm				33W	2700 lm			
<b>8395</b>	<b>2000</b> 2000 mm				44W	3600 lm			
<b>8396</b>	<b>3000</b> 3000 mm				66W	5400 lm			
<b>8397</b>	<b>9000</b> 9000 mm				198W	16200 lm			

#### Notes:

\* For complete code ordering information, please see page 377.

\*\* For other CCT options, please contact us.

EW = Extra Wide. Ordering code: **00**.

# Outdoor Lighting

# Terraluce

Round ground recessed uplight

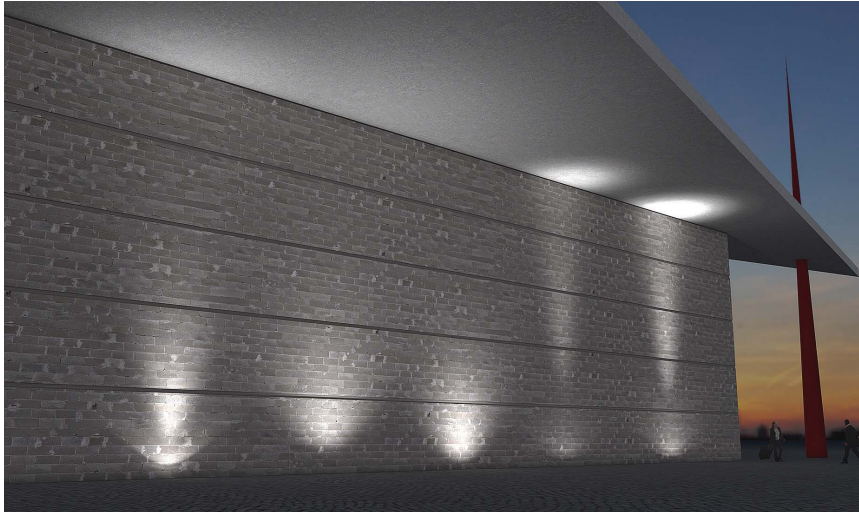

## Body

Round ground recessed uplight with trim in stainless steel (AISI 316) and light body in cast aluminium.

Light trim inclusive of toughened safety glass, weatherproof durable silicone gasket and external screws made of stainless steel.

Thermoplastic recessed box included additional recessed box for concrete installation available upon request. Weight resistance 1300/3000 kg.

Adjustable version tiltable vertically 0-15° in two directions.

## Accessories

Extension signal cable, IP 68 fast connector, electronic power supply, IP68 3-way junction box.

## Finish

Powder coat in Stainless steel colour.

## LED sources

Terraluce 38: Cree power led; Terraluce 130: Nichia and Edison single power led; Terraluce 220: Cree CXA series. CRI: 90 | CCT: 3000K, 4000K, RGB/W, TuneableWhite. Other CRI and CCT options available on request.

## Optic

Beam angle according to chosen lamp. Special beam effect can be obtained by the installation of the appropriate accessory.

## Driver

Terraluce 38: Supplied with no driver to be ordered separately. Terraluce 130/ 220. Supplied with remote or integrated no-dimmable driver. Dimming Options: DMX, CASAMBI, 0-10V Dim, DALI, Phase.

## Applications

Uplighting system with the options of fixed, adjustable, symmetric and asymmetric optic system reflectors to wash or highlight the architectural structure or surfaces. Application areas: facades, parks, golf courses, driveways, sculptures.

### Related Products

**Terraluce  
Linear**  
P.304



# Terraluce 38

24VDC



### Terraluce 38

Ground Recessed

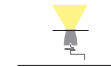
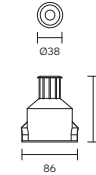

Code ordering example: **3 5 1 2 B R 1 2 - 8 0 3 0 2 0 0 0 8 4**

	Product code	Light source code*	>CRI	CCT**	LED Power	Nominal Lumen	Beam angle (BA°)	Driver Options	Finish	
Terraluce 38	<b>3512</b>	<b>BR12</b>	Cree 3535	<b>80</b>	<b>30</b> 3000K	1W	147 lm	<b>20/36</b>	<b>00</b> No Driver	<b>84</b> Stainless Steel
				<b>40</b> 4000K			158 lm			

### Notes:

\* For complete code ordering information, please see page 377.

\*\* For other CCT options, please contact us.

For related accessories, please see page 303.

24V DC operation.

↓  
500Kg Max. 50°C

## Terraluce 130



**Terraluce 130 Adjustable ± 15°**  
Ground Recessed

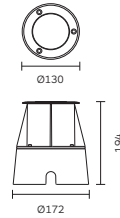

Code ordering example: **3 1 5 7 B N 1 1 - 8 0 3 0 2 4 D 0 8 4**

	Product code	Light source code*	>CRI	CCT**	LED Power	Nominal Lumen	Beam angle (BA°)	Driver Options*	Finish
Terraluce 130 Adjustable ± 15°	<b>3157<sup>†</sup></b>	<b>BN11</b> Nichia 3535	<b>80</b>	<b>30</b> 3000K	3 x 1W	390 lm	<b>24</b>	<b>D0</b> No Dim	<b>84</b> Stainless Steel
				<b>40</b> 4000K		412 lm		<b>DX</b> DMX <b>DA</b> Dali Dim <b>DP</b> Phase <b>D1</b> 0-10 Dim <b>DC</b> CASAMBI	

### Notes:

\* For complete code ordering information, please see page 377.

\*\* For other CCT options, please contact us.

For related accessories, please see page 303.

<sup>†</sup> Driver in IP67 double cable entry box (Dim. 116 x 80 x 69 mm). Supplied with hard wired with 300 mm rubber cable 2 x 1.5 mm<sup>2</sup>.

↓  
**1300Kg Max. 40°C**

## Terraluce 220



**Terraluce 220**  
Symmetric & Assymmetric

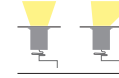
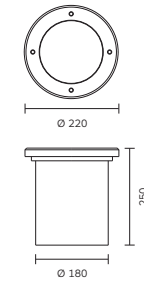

Code ordering example: **3 5 3 5 B R 2 1 - 8 0 3 0 1 9 D 0 8 4**

	Product code	Light source code*	>CRI	CCT**	LED Power	Nominal Lumen	Beam angle (BA°)	Driver Options	Finish
Terraluce220 Symmetric	<b>3535</b>	<b>BR21</b> Cree COB	<b>80</b>	<b>30</b> 3000K	25W	2871 lm	<b>19/35/54</b>	<b>D0</b> No Dim	<b>84</b> Stainless Steel
				<b>40</b> 4000K		3085 lm		<b>DX</b> DMX <b>DA</b> Dali Dim <b>DP</b> Phase <b>D1</b> 0-10 Dim <b>DC</b> CASAMBI	
Terraluce220 Assymmetric	<b>3551</b>						<b>WW</b>	<b>D1</b> 0-10 Dim <b>DC</b> CASAMBI	

### Notes:

\* For complete code ordering information, please see page 377.

\*\* For other CCT options, please contact us.

For related accessories, please see page 303.

↓  
**3000Kg Max. 100°C**

## Terraluce Family configuration options

Code ordering example: 3 5 1 2 BR 1 2 - 8 0 3 0 2 0 0 8 4

### Terraluce 38

Ground Recessed

Product code	Light source code	>CRI	CCT	LED Power	Nominal Lumen	Beam angle (BA°)	Driver Options	Finish
3512	BR12 Cree 3535	80	30 3000K	1W	147 lm	20/36	00 No Driver	84  Stainless Steel
			40 4000K		158 lm			

### Terraluce 130

Ground Recessed | Adjustable ± 15°

Product code	Light source code	>CRI	CCT	LED Power	Nominal Lumen	Beam angle (BA°)	Driver Options	Finish
3157	BN11 Nichia 3535	80	30 3000K	3 x 1W	390 lm	24	D0 No Dim	84  Stainless Steel
			40 4000K		412 lm			
	BN11 Nichia 3535	RG	B0	3 x 1W	/	00	DX DMX	
			BW	/				
GU53 Retrofit	MR16-GU5.3	00	00	/	/	00	00 No Driver	

### Terraluce 220

Ground Recessed | Symmetric & Asymmetric

Product code	Light source code	>CRI	CCT	LED Power	Nominal Lumen	Beam angle (BA°)	Driver Options	Finish
3535	BR12 Cree COB	80	30 3000K	25W	2871 lm	19/35/54	D0 No Dim	84  Stainless Steel
			40 4000K		3085 lm			
3551							WW	
							D1 0-10 Dim	
							DC CASAMBI	

#### Notes:

For other CCT options, please contact us.

## Accessories



Product / Accessories	Extension Signal cable	Extension Signal cable	Fast Connector M20	Electronic Power Supply	3-Way Junction Box
	IP65 / L: 1000 mm	IP65 / L: 2000 mm	IP68	IP20	IP68
	For RGB with M/F connectors. Must be operated outside the water.	For RGB with M/F connectors. Must be operated outside the water.	6 + 12 mm) Connection must be done inside a recess box.	Housing made of high thermoplastic material. Input: 220-240V 50/60Hz. Output: 24V DC Max. 10W.	2 set of gasket rings included suitable for wide range of cable diameters.

### Terraluce 38

Terraluce 130	2478	2479	2577	2137	2355
---------------	------	------	------	------	------

### Terraluce 220

#### Wiring diagram\*

for Art. 3157

100-240V 50/60Hz.



#### Wiring diagram

for Art. 3535, 3551

220-240V 50/60Hz.

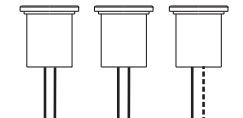

#### Notes:

\* Connection to the Electrical Power Supply can be done inside an accessible Junction Box (by others) or inside the Thermoplastic Box and by means of IP67 Fast Connector Art. 2577. This ensures the safety and prevents ingress of moisture into the fitting.



# Terraluce Linear

Recessed walk-drive over Uplighters

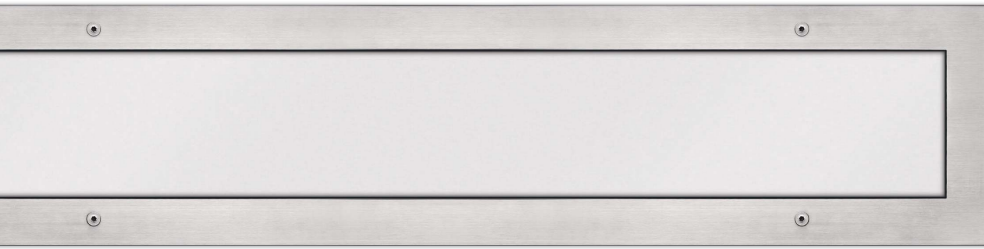

## Body

Linear recessed walk-drive over uplighters with trim in stainless steel (AISI 316) and light housing in extruded aluminium.

Light trim inclusive of toughened safety glass, weatherproof durable silicone and external screws of stainless steel.

Thermoplastic recessed box included additional recessed box for installation in concrete available upon request.

Equipped with hard wire rubber cable. Weight resistance 1000 kg.

## Accessories

IP68 fast connector, aluminium white louver, IP68 3-way junction box.

## Finish

Powder coat in Stainless steel colour.

## LED sources

Nichia single power led. Lextar SMD series. CRI: 80 | CCT: 3000K, 4000K, TuneableWhite, RGB/W.

Other CRI and CCT options available on request.

## Optic

Lens or frosted glass diffuser.

## Driver

Supplied with integrated no-dimmable or DMX driver. Dimming Options: 0-10V Dim, DALI, Phase, CASAMBI.

## Applications

A minimal visual impact and maximum flexibility and can be used to create continuous light line as a marker light and to light wash low walls. It is a Cool Touch as the temperature on the glass is low. Application areas: signboards, playgrounds, town squares, sculptures, architectural enhancement, pathways.

## Related Products

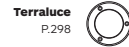

# Terraluce Linear



## Terraluce Linear Lens

Recessed Ground

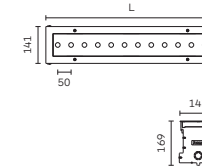

## Terraluce Linear Opal diffuser

Recessed Ground

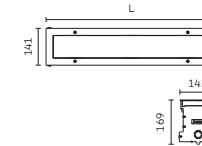

Code ordering example: **3 3 1 0 B N 1 1 - 8 0 3 0 2 5 D 0 8 4**

	Product code	Light source code*	Length (L)	>CRI	CCT**	LED Power	Nominal Lumen	Beam angle (BA°)	Driver Options	Finish
Terraluce Linear Lens	<b>3310</b>	<b>BN11</b> Nichia 3535	600	<b>80</b>	<b>30</b> 3000K	12 x 3W	1500 lm	<b>25</b>	<b>D0</b> No Dim	<b>84</b> Stainless Steel
			900	<b>40</b> 4000K	1800 lm					
	<b>3311</b>		900			18 x 3W	2250 lm		<b>DX</b> DMX	
			1200			2700 lm		<b>D1</b> 0-10 Dim		
Terraluce Linear Opal diffuser	<b>3312</b>		1200			24x3W	3000 lm		<b>DP</b> Phase	
						3600 lm		<b>DC</b> CASAMBI		
	<b>3500</b>	<b>BT11</b> Lextar SMD	600			40W	2400 lm	<b>EW (00)</b>		
			900			60W	3600 lm			
<b>3501</b>						3900 lm				
<b>3502</b>						80W	4800 lm			
							5200 lm			

## Notes:

\* For complete code ordering information, please see page 377.

\*\* For other CCT options, please contact us.

For related accessories, please see page 307.

EW = Extra Wide. Ordering code: **00**.

↓  
**1000Kg Max. 40°C**

## Terraluce Linear Family configuration options

Code ordering example: 3 5 0 0 BN 1 1 - 8 0 3 0 0 0 0 8 4

### Terraluce Linear LED

Lens | Opal | Ground Recessed

Product code	Light source code	Length (L)	>CRI	CCT	LED Power	Nominal Lumen	Beam angle (BA°)	Driver Options	Finish
3500	BT11 Lextar SMD	600	80	30 3000K	40W	2400 lm	EW (00)	D0 No Dim	84  Stainless Steel
				40 4000K		2600 lm		DX DMX	
3310	BN11 Nichia 3535				12 x 3W	1500 lm	25	DA Dali Dim	
						1800 lm		D1 0-10 Dim	
								DP Phase	
								DC CASAMBI	
			RG*	B0	12 x 3W	/	00	DX DMX	
				BW				DC CASAMBI	
3501	BT11 Lextar SMD2835	900	80	30 3000K	40W	3600 lm	EW (00)	D0 No Dim	
				40 4000K		3900 lm		DX DMX	
3311	BN11 Nichia NVSL219CT				18 x 3W	2250 lm	25	DA Dali Dim	
						2700 lm		D1 0-10 Dim	
								DP Phase	
								DC CASAMBI	
			RG	B0	18 x 3W	/	00	DX DMX	
				BW				DC CASAMBI	
3502	BT11 Lextar SMD	1200	80	30 3000K	40W	4800 lm	EW (00)	D0 No Dim	
				40 4000K		5200 lm		DX DMX	
3312	BN11 Nichia 3535				24 x 3W	3000 lm	25	DA Dali Dim	
						3600 lm		D1 0-10 Dim	
								DP Phase	
								DC CASAMBI	
			RG	B0	24 x 3W	/	00	DX DMX	
				BW				DC CASAMBI	

#### Notes:

For other CCT options, please contact us.

EW = Extra Wide. Ordering code: **00**.

DMX signal converter with facility to connect In/Out cables for multiple connections. (Occupies 3 control channels).

## Accessories

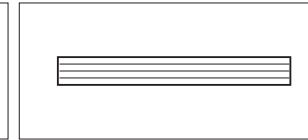

#### Product / Accessories

#### Fast Connector M20

IP68

( 6 + 12 mm)

Connection must be done inside an accessible box.

#### Louvre

Available in colour 10.

In aluminium.

#### 3-Way Junction Box

IP68

2 set of gasket rings included suitable for wide range of cable diameters:

( Ø5 - Ø8 mm)

( 8 - Ø14 mm)

For L: 654 mm

For L: 954 mm

For L: 1254 mm

#### Terraluce Linear

2577

2514

2515

2616

2355

#### Notes:

For complete code ordering information, please see page 377.

# StellaLED | InoxLED

Recessed step/driveway uplight

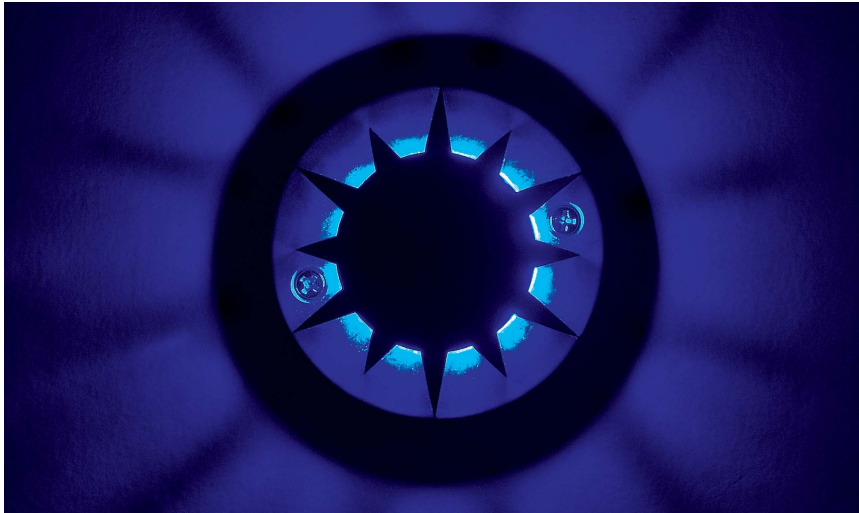

## Body

Recessed step/driveway uplight. StellaLED trim and light body in cast aluminium.

InoxLED trim in stainless steel and light body in cast aluminium. Inclusive of toughened safety convex clear polycarbonate and weatherproof durable silicone gasket and external counter sink captive screws made of stainless steel.

Thermoplastic box for in-ground recessed installation included.

Recessed box for installation in concrete to be ordered separately.

## Accessories

Driver, IP67 driver box, thermoplastic box, IP68 fast connector, IP68 3-way junction box.

## Finish

Powder coat in grey (StellaLED) or stainless steel (InoxLED) colour.

## LED sources

Nichia single power led. CRI: 80 | CCT: 3000K, 4000K. Other CRI and CCT options available on request.

## Optic

StellaLED: no optics.  
InoxLED: frosted acrylic diffuser.

## Driver

Driver not included, to be order separately.  
Product operate on 24V DC.

## Applications

A fully comprehensive range of path luminaires installable on wooden/gypsum board walls, in concrete or as a recessed ground/wall luminaire. Miniature design ideal to fit in any architectural environment. Application areas: staircases, lighting steps, walkways, gardens, parks, garage.

## Related Products

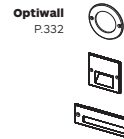

# StellaLED

24VDC



## StellaLED 1 / 2

Ground Recessed



## StellaLED 6 / 12

Ground Recessed



Code ordering example: **3 4 5 7 B N 1 1 - 8 0 3 0 0 0 2 9**

	Product code	Light source code*	>CRI	CCT**	LED Power	Nominal Lumen	Beam angle (BA°)	Driver Options	Finish
StellaLED 1	<b>3457</b>	<b>BN11</b> Nichia 3535	<b>80</b>	<b>30</b> 3000K	1W	130 lm	EW ( <b>00</b> )	<b>00</b> No Driver	<b>29</b> Grey (Outdoor)
StellaLED 2	<b>3458</b>			<b>40</b> 4000K		137 lm			
StellaLED 6	<b>3459</b>								
StellaLED 12	<b>3460</b>								

## Notes:

\* For complete code ordering information, please see page 377.

\*\* For other CCT options, please contact us.

For related accessories, please see page 311.

EW = Extra Wide. Ordering code: **00**.

↓  
1000Kg Max. 40°C

# InoxLED

24VDC



**InoxLED 1 / 3 / 4**  
Ground Recessed

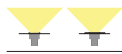
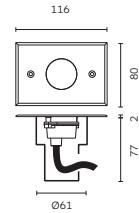
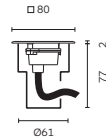
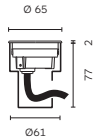

Code ordering example: **3 4 6 5 B N 1 1 - 8 0 3 0 0 0 2 9**

	Product code	Light source code	>CRI	CCT	LED Power	Nominal Lumen	Beam angle (BA°)	Driver Options	Finish
InoxLED 1	<b>3465</b>	<b>BN11</b> Nichia 3535	<b>80</b>	<b>30</b> 3000K	1W	130 lm	EW ( <b>00</b> )	<b>00</b> No Driver	<b>29</b> Grey (Outdoor)
InoxLED 3	<b>3466</b>			<b>40</b> 4000K		137 lm			
InoxLED 4	<b>3467</b>								

### Notes:

\* For complete code ordering information, please see page 377.

\*\* For other CCT options, please contact us.

For related accessories, please see page 311. EW = Extra Wide. Ordering code; **00**. Complete with thermoplastic box for in-ground recess.

↓  
**1000Kg Max. 40°C**

# Accessories

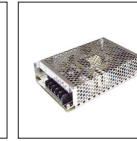
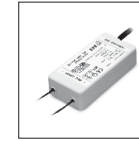

Product / Accessories	Electronic Power Supply	Electronic Power Supply	Electronic Power Supply	3-Way Junction Box	Fast Connector M20
	IP20	IP67	IP20	IP68	IP68
	Housing made of high thermoplastic material. Input: 220-240V 50/60Hz. Output: 24V DC Max. 10W.	Input: 220-240V 50/60Hz. Output: 24V DC Max. 12W. With 3 meters cable length for DC output. With 2 entries with PG9 cable glands.	Input: 100-240V 50/60Hz. Output: 24V DC Max. 25W.	2 set of gasket rings included suitable for wide range of cable diameters: (Ø 5 - Ø8 mm) (Ø 8 - Ø14 mm)	(Ø 6 + 12 mm) Connection must be done inside a recess box.
<b>StellaLED 1 / 2 / 6 / 12</b>	<b>2137</b>	<b>2688</b>	<b>2715</b>	<b>2355</b>	<b>2577</b>
<b>InoxLED 1 / 3 / 4</b>					



**Product / Accessories** Thermoplastic Box

Thermoplastic box for installation as recessed into wall or ground (included).

**StellaLED**

**1 / 2 / 6 / 12**

**InoxLED**

**1 / 3 / 4**



### Notes:

Connection to the Electrical Power Supply can be done inside an accessible Junction Box (by others) or inside the Thermoplastic Box Art. 2359 and by means of IP67 Fast Connector Art. 2577.

This ensures the safety and prevents ingress of moisture into the fitting.

To maintain IP67 integrity use cable type H07RN-F 2x1mm² Ø6-10mm.

### Wiring diagram

With standard box

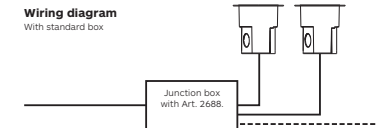

### Wiring diagram

With box Art. 2359, power supply Art. 2688 and connector Art. 2577.

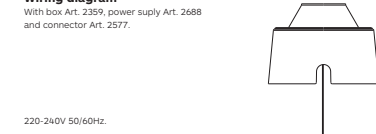

220-240V 50/60Hz.

# Fontanaluce

Recessed / Surface mounted underwater luminaire

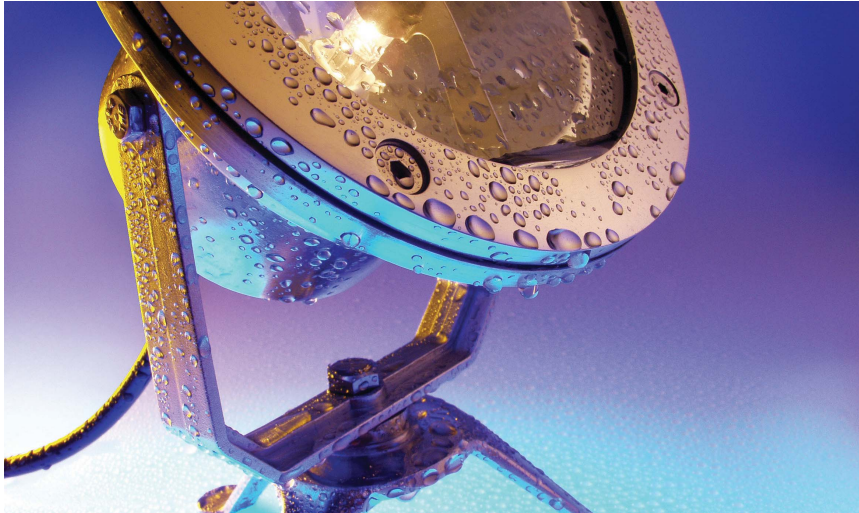

## Body

Recessed/ground mounted underwater luminaire with housing and tripod base (ground version) in cast stainless steel (AISI 316) with toughened thermal-shock glass, durable silicone gasket and external screws of stainless steel.

IP68 fixture (pressure water tight up to 600mm).

Easy electrical installation via the included hard wire rubber cable.  
Ground version equipped with mechanical locking system to ensure aiming stability.

## Accessories

IP65 extension signal cable, IP65 junction box.

## Finish

Powder coat in Stainless steel colour.

## LED sources

Edison single power led. CRI: 80 | CCT: 3000K, 4000K, tuneable white, RGB/W.

Other CRI and CCT options available on request.

## Optic

Lens.  
Medium and wide beam angle available.

## Driver

Supplied, According with the chosen model, with no-dimmable or DMX remote driver inclusive of IP67 driver box.  
Dimming Options: 0-10V Dim, DALI, Phase, CASAMBI.

## Applications

Designed for use into fresh water (no salt or spring water installation) integrating RGB color-changing or dimming control technology. Can be flush recessed in the wall or as free standing portable light and may be used for indoor or outdoor applications. Application areas: pools, fountains, ponds, gardens.

## Related Products

**Fronteluce**  
P.352



**Forlinea**  
P.348

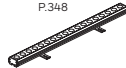

# Fontanaluce



**Fontanaluce**  
Recessed



**Fontanaluce**  
Surface



Code ordering example: **3 0 7 5 B N 1 1 - 8 0 3 0 1 1 D 0 8 4**

	Product code	Light source code*	>CRI	CCT**	LED Power	Nominal Lumen	Beam angle (BA°)	Driver Options	Finish	
Fontanaluce Recessed	<b>3075</b>	<b>BN11</b> Nichia	3535	<b>80</b>	<b>30</b> 3000K	12W	1150 lm	<b>11/24/40</b>	<b>D0</b> No Dim	<b>84</b> Stainless Steel
				<b>40</b> 4000K			1640 lm	<b>DX</b> DMX		
Fontanaluce Surface	<b>3073</b>							<b>DA</b> Dali Dim		
								<b>D1</b> 0-10 Dim		
								<b>DP</b> Phase		
								<b>DC</b> CASAMBI		
								<b>RG</b>		
								<b>B0</b>		
								<b>00</b>		
								<b>DX</b> DMX		
								<b>BW</b>		
								<b>DC</b> CASAMBI		

## Notes:

\* For complete code ordering information, please see page 377.

\*\* For other CCT options, please contact us.

For related accessories, please see page 315.

## Fontaluce Family configuration options

Code ordering example: 3 0 7 5 BN11 1 - 80 30 11 D0 84

### Fontaluce

Product code	Light source code	>CRI	CCT	LED Power	Nominal Lumen	Beam angle (BA°)	Driver Options	Finish
<b>3075</b>	<b>BN11</b> Nichia 3535	<b>80</b>	<b>30</b> 3000K	12W	1150 lm	<b>11/24/40</b>	<b>D0</b> No Dim	<b>84</b>  Sainless Steel
			<b>40</b> 4000K		1640 lm		<b>DX</b> DMX	
							<b>DA</b> Dali Dim	
							<b>D1</b> 0-10 Dim	
							<b>DP</b> Phase	
							<b>DC</b> CASAMBI	
		<b>RG</b>	<b>B0</b>		/	<b>00</b>	<b>DX</b> DMX	
			<b>BW</b>				<b>DC</b> CASAMBI	

### Recessed

### Fontaluce

Product code	Light source code	>CRI	CCT	LED Power	Nominal Lumen	Beam angle (BA°)	Driver Options	Finish
<b>3073</b>	<b>BN11</b> Nichia 3535	<b>80</b>	<b>30</b> 3000K	12W	1150 lm	<b>11/24/40</b>	<b>D0</b> No Dim	<b>84</b>  Sainless Steel
			<b>40</b> 4000K		1640 lm		<b>DX</b> DMX	
							<b>DA</b> Dali Dim	
							<b>D1</b> 0-10 Dim	
							<b>DP</b> Phase	
							<b>DC</b> CASAMBI	
		<b>RG</b>	<b>B0</b>		/	<b>00</b>	<b>DX</b> DMX	
			<b>BW</b>				<b>DC</b> CASAMBI	

### Ground

## Accessories



### Product / Accessories

Extension Signal cable	Extension Signal cable	Junction Box
IP65 / L: 1000 mm	IP65 / L: 2000 mm	IP65
For RGB with M/F connectors. Must be operated outside the water.	For RGB with M/F connectors. Must be operated outside the water.	Empty box with multi-cable entries. Electronic power supply for LED not included. To be ordered separately and to be placed inside junction box. Dimension: 130 x 94 x 56mm

### Fontaluce Recessed

2478

2479

2576

### Fontaluce Ground

### Single colour wiring diagram



### RGB wiring diagram

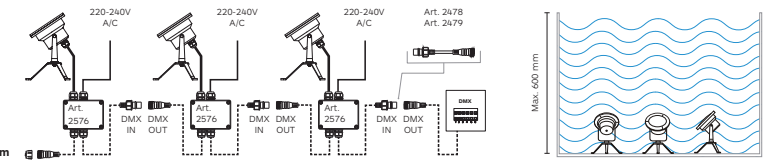

### Notes:

For other CCT options, please contact us.

# Trafofo

Designed by Franco Mirezzi



## Body

Wall and pole mounted light system with body visor housing and ribbed LED dissipator in cast aluminium, inclusive weatherproof silicone gasket and concealed stainless steel screws.

Light pole in extruded aluminium. The safety glass is fitted within the luminaire for easy cleaning.

Easy installation via the included hard wire rubber cable and IP67 fast connector.

## Accessories

Anchor bolt kit (2231).

## Finish

Superior polyester powder coat in black or grey colour.

## LED sources

Nichia single power led. CRI: 80 | CCT: 3000K, 4000K.

Other CRI and CCT options available on request.

## Optic

Frosted glass diffuser.

## Driver

Single colour version Supplied with integrated non-dimmable driver.

Dimming Options: 0-10V Dim, DALI, Phase, DMX, CASAMBI.

## Applications

Extremely compact designed outdoor luminaire. Its appearance blends into any exterior design to provide lighting designers and architects many application possibilities. Application areas: landscapes, parks, walkways, pathways, walls, entrances, golf courses, gardens, bridges.

## Related Products

**Cornetto**  
P.318



**Corolla**  
P.320



# Trafofo



## Trafofo Wall Single & Double

Single Up or Down | Double Up & Down

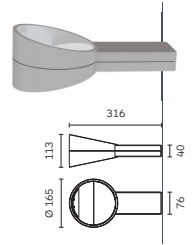
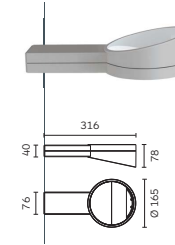

## Trafofo Bollard

Single & Double

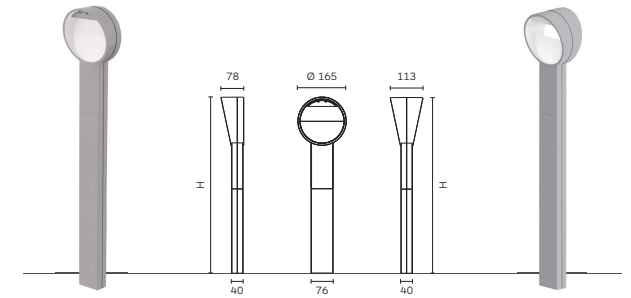

Code ordering example: **3 4 5 1 B N 1 1 - 8 0 3 0 0 0 D 0 1 1**

	Product code	Height (H)	Light source code*	>CRI	CCT**	LED Power	Nominal Lumen	Beam angle (BA°)	Driver Options	Finish
						Up / Down	Up / Down	EW (00)	Options	
Trafofo Wall single Up or Down	<b>3451</b>		<b>BN11</b> Nichia 3535	<b>80</b>	<b>30</b> 3000K	6.3W	705 lm	<b>EW (00)</b>	<b>D0</b> No Dim	<b>11</b> □ White
Trafofo Wall Double Up & Down	<b>3452</b>				<b>40</b> 4000K		750 lm		<b>DX</b> DMX	<b>29</b> ■ Grey
Trafofo Bollard Single	<b>3453</b>	600							<b>D1</b> 0-10 Dim	
Trafofo Bollard Double	<b>3454</b>	1000							<b>DP</b> Phase	
									<b>DC</b> CASAMBI	
Trafofo Bollard Single	<b>3455</b>	600								
Trafofo Bollard Double	<b>3456</b>	1000								

## Notes:

\* For complete code ordering information, please see page 377.

\*\* For other CCT options, please contact us.

For related accessories, please see page 374.

EW = Extra Wide. Ordering code: **00**.

For the items code 3452, 3455 and 3456 LED power is double (6.3W x 2).

# Cornetto

Designed by Franco Mirenzi



## Body

Surface mounted/bollard light system with diffuser base's, housed ribbed LED dissipator and top canopy in cast aluminium.

Vandal proof prismatic diffuser in polycarbonate thermoplastic, light pole in extruded aluminium, inclusive of weatherproof silicone gasket and concealed stainless steel screws.

Designed for an indirect light technique have the reflector and canopy with inner white finish.

## LED sources

Bridgelux Vero series.  
CRI: 80 | CCT: 3000K, 4000K.

Other CRI and CCT options available on request.

## Optic

Prismatic acrylic diffuser.

## Related Products

**Trafo**  
P.316



**Corolla**  
P.320



## Accessories

Anchor bolt kit (Z601).

## Driver

Supplied with integrated no-dimmable driver.  
Dimming Options: 0-10V Dim, DALI, Phase, CASAMBI.

## Finish

Superior polyester powder coat in black or grey colour.

## Applications

A strong design appeal that will enhance all modern and classic environments for residential and/or commercial applications. Application areas: landscapes, parks, walkways, pathways, entrances, walls, golf courses, gardens, bridges.

# Cornetto



**Cornetto**  
Wall



**Cornetto**  
Bollard



Code ordering example: **3 4 4 1 M B 1 3 - 8 0 3 0 0 D 0 1 0**

	Product code	Height (H)	Light source code*	>CRI	CCT**	LED Power	Nominal Lumen	Beam angle (BA°)	Driver Options	Finish
Cornetto Wall	<b>3441</b>		<b>MB13</b> Bridgelux COB	<b>80</b>	<b>30</b> 3000K	19W	2919 lm	<b>EW (00)</b>	<b>D0</b> No Dim	<b>10</b> ■ Black
					<b>40</b> 4000K	3008 lm	<b>DA</b> DMX	<b>29</b> ■ Grey		
Cornetto Bollard	<b>3444</b>	600							<b>DA</b> Dali Dim	
	<b>3447</b>	1100							<b>D1</b> 0-10 Dim	
	<b>3450</b>	2000							<b>DP</b> Phase	
									<b>DC</b> CASAMBI	

## Notes:

\* For complete code ordering information, please see page 377.  
\*\* For other CCT options, please contact us.  
For related accessories, please see page 374.  
EW = Extra Wide. Ordering code: **00**.



# Corolla

Designed by Franco Mirezzi

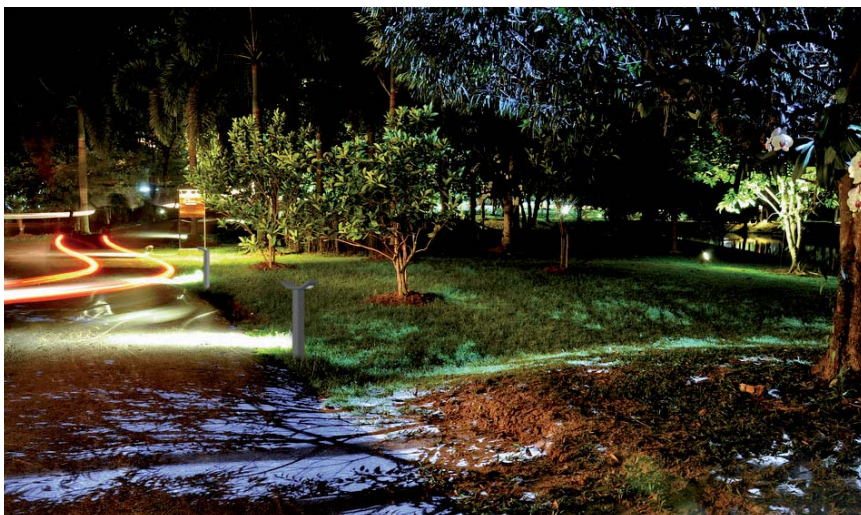

## Body

Wall/pole/bollard mounted light system with light body and trim in cast aluminium.

Light body inclusive of tempered glass diffuser, weatherproof silicone gasket and stainless steel screws.

Electrical installation option for single or double cable entry.

Anchor bolt kit for concrete foundation installation is available as accessory.

## Accessories

Anchor bolt kit (Z601).

## Finish

Superior polyester powder coat in black or grey colour.

## LED sources

Citizen CLU series.

CRI: 80 | CCT: 3000K, 4000K.

Other CRI and CCT options available on request.

## Optic

Lens.

Narrow, medium and wide beam angle available.

## Driver

Supplied with integrated no-dimmable driver.

Dimming Options: 0-10V Dim, DALI, Phase, CASAMBI.

## Applications

Outdoor lighting system to illuminate upwards or downwards on the ground providing optimal visual comfort. Offer in different mounting alternative (post/wall). Application areas: landscapes, parks, walkways, pathways, walls, entrances, golf courses, gardens, bridges.

## Related Products

Trafofo  
P.316



# Corolla

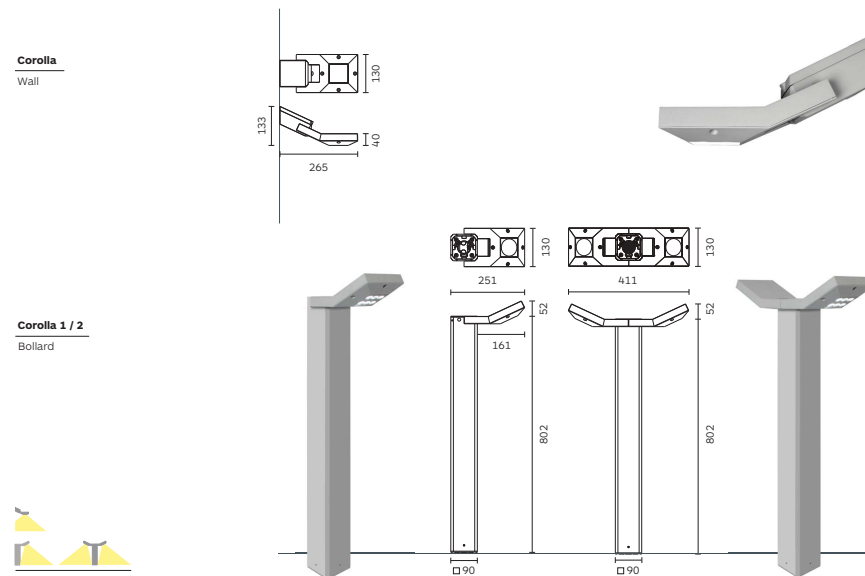

Code ordering example: **3 5 0 7 B C 2 2 - 8 0 3 0 2 0 D 0 1 0**

	Product code	Light source code*		>CRI	CCT**	LED Power	Nominal Lumen	Beam angle (BA°)	Driver Options	Finish	
Corolla Wall	<b>3507</b>	<b>BC22</b>	Citizen COB	<b>80</b>	<b>30</b>	3000K	9W	1275 lm	<b>20/28/40</b>	<b>D0</b> No Dim	<b>10</b> ■ Black
				<b>40</b>	<b>4000K</b>			1308 lm	<b>DX</b> DMX	<b>29</b> ■ Grey (Outdoor)	
Corolla Bollard 1	<b>3508</b>								<b>DA</b> Dali Dim		
									<b>D1</b> 0-10 Dim		
Corolla Bollard 2	<b>3509</b>								<b>DP</b> Phase		
									<b>DC</b> CASAMBI		

## Notes:

\* For complete code ordering information, please see page 377.

\*\* For other CCT options, please contact us.

For related accessories, please see page 374.

# FioreLED

Designed by Franco Mirezni



## Body

Miniature ground/wall spot light system with base, back plug cover and light head in cast aluminium. Inclusive of toughened safety glass, optical lenses, weatherproof durable silicone gasket, stainless steel screws and flexible arm made of brass with external black heat-shrink sheath.

Fixture is available in 2 different bases, Round or Rectangular.

Electrical installation includes double cable entry for through wiring.

## Accessories

Spikes for ground installation.

## Finish

Superior polyester powder coat in black and grey colour.

## LED sources

Nichia single power led. CRI: 80 | CCT: 3000K, 4000K, tuneable white, single colour.

Other CRI and CCT options available on request.

## Optic

Lens.  
Medium, wide and superwide beam angle available.

## Driver

Supplied with integrated no-dimmable driver.  
Dimming Options: 0-10V Dim, DALI, Phase, CASAMBI.

## Applications

The glare shield cap integrated in the design maintains the environment from unpleasant glare light. Earth spike for portable or temporary use. Application areas: greenhouses, flowers, trees, plants, bushes, signboards, sculptures, architectural enhancement.

## Related Products



# FioreLED



## FioreLED Round base

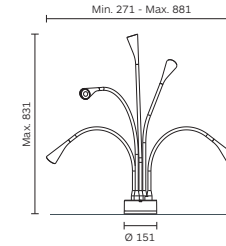

## FioreLED Rectangular base

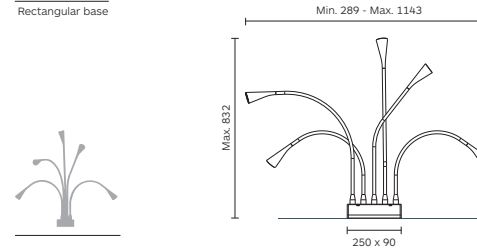

Code ordering example: **3 4 3 7 B N 1 1 - 8 0 3 0 1 6 D 0 9 2**

	Product code	Light source code*	>CRI	CCT**	LED Power	Nominal Lumen	Beam angle (BA°)	Driver Options	Finish
FioreLED Round base	<b>3437</b>	<b>BN11</b>	Nichia 3535	<b>80</b>	<b>30</b> 3000K	5x2W 1175 lm	<b>16/26/40</b>	<b>D0</b> No Dim	<b>92</b> Black/Grey
FioreLED Rectangular base	<b>3438</b>			<b>40</b> 4000K		1250 lm		<b>DX</b> DMX <b>DA</b> Dail Dim <b>D1</b> 0-10 Dim <b>DP</b> Phase <b>DC</b> CASAMBI	

## Notes:

- \* For complete code ordering information, please see page 377.
  - \*\* For other CCT options, please contact us.
- For related accessories, please see page 374.

# Bullet

Ceiling recessed uplight



## Body

Recessed and surface luminaire with light housing in aluminium extrusion inclusive of with toughened safety glass, weatherproof durable silicone gasket and external screws made of stainless steel. Ring and back plug cover in cast aluminium.

Base and bracket (surface version) in cast aluminium. Front cover designed to avoid accumulation of dust and water.

Ceiling installation via clamping wings for ceiling thickness 1 to max.30mm. Surface version tiltable vertically 0-140° and rotatable horizontally 350°, inclusive of mechanical locking system to ensure aiming stability.

## Accessories

Coloured filter, linear spread, Visor, spike, extension signal cable.

## Finish

Superior polyester powder coat in black and grey colour.

## LED sources

Bridgelux Vero series.

CRI: 90, 95 | CCT: 3000K, 4000K.  
Other CRI and CCT options available on request.

## Optic

Reflector or lens. Narrow, medium and wide beam angle available.

## Driver

Bullet Recessed: Supplied with remote no-dimmable driver in a IP66 box.

Bullet Floodlight: Supplied with integrated no-dimmable driver. Dimming Options: 0-10V Dim, DALI, Phase, CASAMBI.

## Applications

Versatile series can be used as recessed fixture or mounted on ground/wall. The visor shield protects the environment from unpleasant bright light. Application areas: canopies, entrances, warehouses, garages (Recessed), Facades, gardens, signboards, sculptures, residential (Surface).

## Related Products



# Bullet



**Bullet 127 / Bullet 166**  
Recessed

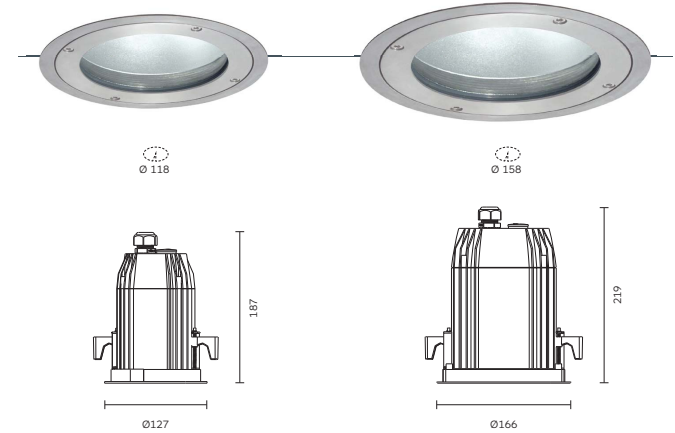

Code ordering example: **3 4 9 9 B R 1 2 - 8 0 3 0 1 4 D 0 1 0**

	Product code	Light source code*		>CRI	CCT**	LED Power	Nominal Lumen	Beam angle (BA°)	Driver Options	Finish
Bullet 127	<b>3499</b>	<b>BB12</b>	Bridgelux COB	<b>80</b>	<b>30</b> 3000K	14W	2152 lm	<b>14/22/32</b>	<b>D0</b> No Dim	<b>10</b> Black
				<b>40</b>	4000K		2220 lm		<b>DX</b> DMX	<b>29</b> Grey (Outdoor)
Bullet 166	<b>3497</b>	<b>BB13</b>				20W	3067 lm	<b>16/28/40</b>	<b>DA</b> Dali Dim	
							3170 lm		<b>D1</b> 0-10 Dim	
									<b>DP</b> Phase	
									<b>DC</b> CASAMBI	

## Notes:

\* For complete code ordering information, please see page 377.

\*\* For other CCT options, please contact us.

## Bullet



### Bullet 89

Floodlight



### Bullet 130

Floodlight



Code ordering example: **3 4 9 8 B B 1 2 - 8 0 3 0 1 4 D 0 1 0**

	Product code	Light source code*		>CRI	CCT**	LED Power	Nominal Lumen	Beam angle (BA°)	Driver Options	Finish
Bullet 89	<b>3498</b>	<b>BB12</b>	Bridgelux COB	<b>80</b>	<b>30</b> 3000K	14W	2152 lm	<b>14/22/32</b>	<b>D0</b> No Dim	<b>10</b> ■ Black
					<b>40</b> 4000K		2220 lm		<b>DX</b> DMX	<b>29</b> ■ Grey (Outdoor)
Bullet 130	<b>3496</b>	<b>BB13</b>	Bridgelux COB			20W	3067 lm	<b>16/28/40</b>	<b>DA</b> Dali Dim	
							3170 lm		<b>D1</b> 0-10 Dim	
									<b>DP</b> Phase	
									<b>DC</b> CASAMBI	

#### Notes:

- \* For complete code ordering information, please see page 377.
- \*\* For other CCT options, please contact us.
- For related accessories, please see page 327.

## Accessories



Product / Accessories	Coloured Filters Colours 25, 42, 55, 85	Linear Spread Colour 41	Visor Colours 10	Spike Colour 10
<b>Bullet 89</b>	<b>2607</b>	<b>2608</b>	<b>2328</b>	<b>2330 / 2322</b>
<b>Bullet 130</b>	<b>2610*</b>	<b>2609</b>	<b>2329</b>	<b>2330</b>

In plastic:  
 +H: 235 for code 2330.  
 +H: 230 for code 2322.  
 The 50 mm upper part must stay above ground level according to standards.

#### Notes:

- \* Available only for white colour version.
- For complete code ordering information, please see page 377.

# Scudo

Designed by Franco Mirezzi



## Body

Recessed/surface luminaire with light housing in cast aluminium inclusive of toughened thermal-shock frosted glass or polycarbonate diffuser, weatherproof durable silicone gasket and external screws made of stainless steel. Glare free optional grid in cast aluminium.  
 Recessed: Thermoplastic recessed box included. Ceiling installation via clamping wings for ceiling thickness 10mm to max.40mm.  
 Surface: Available with wall, ground and pole mounting options.  
 Front cover designed to avoid accumulation of dust and water. Electrical installation includes option for single or double cable entries.

## Accessories

Thermoplastic box for concrete installation, IP66 waterproof box. IP68 fast connector. Frosted glass. Pole mounted bracket set.  
 For complete list of accessories see page 374.

## Finish

Superior polyester powder coat in black and grey colour.

## LED sources

Samsung SMD.  
 CRI: 80 | CCT: 3000K, 4000K.

Other CRI and CCT options available on request.

## Optic

Diffuser of frosted glass or polycarbonate.  
 Optional front grid.

## Driver

Supplied with integrated no-dimmable driver.  
 Dimming Options: 0-10V Dim, DALI, Phase, CASAMBI.

Emergency kit available upon request.

## Applications

Floodlight providing a soft and uniform, glare free, light distribution on the illuminated surface. Surface version can be mounted on the ground, wall, wall extension, ceiling and pole. Application areas: canopies, gyms, swimming pools, garages, façades, billboards, sculptures.

## Related Products

Orbit  
 P.344



# Scudo Recessed



**Scudo Asymmetric** Glass Diffuser  
 Ceiling Recessed



**Scudo Ramp** Glass Diffuser + Grid  
 Wall Recessed

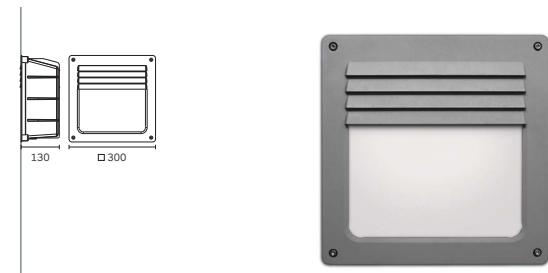

Code ordering example: **3 4 9 5 B M 1 1 - 8 0 3 0 0 0 D 0 1 0**

	Product code	Light source code*	>CRI	CCT**	LED Power	Nominal Lumen	Beam angle (BA°)	Driver Options	Finish
Scudo Ceiling Asymmetric	<b>3495</b>	<b>BM11</b> Samsung SMD	<b>80</b>	<b>30</b> 3000K	30W	4284 lm	EW ( <b>00</b> )	<b>D0</b> No Dim	<b>10</b> ■ Black
Scudo Ramp Wall	<b>3494</b>			<b>40</b> 4000K		4482 lm		<b>D1</b> 0-10 Dim <b>DP</b> Phase <b>DC</b> CASAMBI	<b>29</b> ■ Grey (Outdoor)

## Notes:

- \* For complete code ordering information, please see page 377.
  - \*\* For other CCT options, please contact us.
- EW = Extra Wide. Ordering code: **00**.

## Scudo Wall | Ground



**Scudo Wall** with Glass diffuser  
Adjustable Surface Mounted

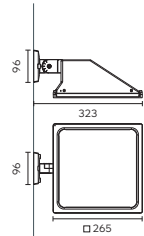

**Scudo Wall** with Glass diffuser + Grid  
Adjustable Surface Mounted

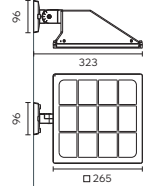

Code ordering example: **3 4 8 9 B M 1 1 - 8 0 3 0 0 0 D 0 1 0**

	Product code	Light source code*	>CRI	CCT**	LED Power	Nominal Lumen	Beam angle (BA°)	Driver Options	Finish
Scudo Wall Adjustable	<b>3489</b>	<b>BM11</b> Samsung 5030	<b>80</b>	<b>30</b> 3000K	30W	1800 lm	EW ( <b>00</b> )	<b>D0</b> No Dim	<b>10</b> ■ Black
				<b>40</b> 4000K		4480 lm		<b>DA</b> Dali Dim	<b>29</b> ■ Grey (Outdoor)
Scudo Wall with Grid Adjustable	<b>3490</b>							<b>D1</b> 0-10 Dim	
								<b>DP</b> Phase	
								<b>DC</b> CASAMBI	

### Notes:

\* For complete code ordering information, please see page 377.  
 \*\* For other CCT options, please contact us.  
 For related accessories, please see page 374.  
 EW = Extra Wide. Ordering code: **00**.

## Scudo Wall



**Scudo Wall** Polycarbonate diffuser  
Fixed Surface Mounted

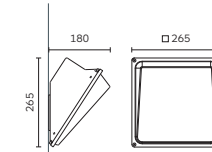

**Scudo Wall** Glass diffuser  
Fixed Surface Mounted

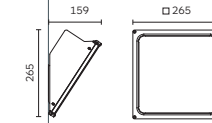

**Scudo Wall** Glass diffuser + Grid  
Fixed Surface Mounted

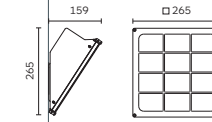

Code ordering example: **3 4 9 1 B M 1 1 - 8 0 3 0 0 0 D 0 1 0**

	Product code	Light source code*	>CRI	CCT**	LED Power	Nominal Lumen	Beam angle (BA°)	Driver Options	Finish
Scudo Wall Polycarbonate diffuser Fixed	<b>3491</b>	<b>BM11</b> Samsung 5030	<b>80</b>	<b>30</b> 3000K	30W	4284 lm	EW ( <b>00</b> )	<b>D0</b> No Dim	<b>10</b> ■ Black
				<b>40</b> 4000K		4482 lm		<b>DA</b> Dali Dim	<b>29</b> ■ Grey (Outdoor)
Scudo Wall Fixed	<b>3492</b>							<b>D1</b> 0-10 Dim	
								<b>DP</b> Phase	
Scudo Wall with Grid Fixed	<b>3493</b>							<b>DC</b> CASAMBI	

### Notes:

\* For complete code ordering information, please see page 377.  
 \*\* For other CCT options, please contact us.  
 For related accessories, please see page 374.  
 EW = Extra Wide. Ordering code: **00**.  
 IP65 for item code 3491. IP66 for items code 3492 and 3493.

# Optiwall

Wall recessed steplight



## Body

Wall recessed steplight luminaire with front frame in cast aluminium inclusive of toughened thermal-shock safety glass diffuser, weatherproof durable silicone gasket and external screws made of stainless steel.

Front frame with slot design for wall washing effect. Easy installations via the included hard wire 600mm long cable (type H05-RN-F 3x0,75mm<sup>2</sup>).

Inclusive of thermoplastic recessed box. Additional recessed box for pre-installation in concrete during wall construction is available on request.

Available in two style (with or without external counter sink) and three shapes - round, square and rectangular.

## Accessories

IP68 extension signal cable, IP68 junction box. For complete list of accessories see page 374.

## Finish

Superior polyester powder coat in grey colour.

## LED sources

Lextar SMD Series.  
CRI: 80 | CCT: 3000K, 4000K.

Other CRI and CCT options available on request.

## Optic

Frosted glass diffuser.

## Driver

Supplied with integrated no-dimmable driver.

## Applications

Optiwall: equipped with a special shaped glass to direct an asymmetric light distribution on the ground. Optiwall Stainless Steel: equipped with opal diffuser to give an uniform light distribution. Application areas: staircases, lighting steps, corridors, walkways, guidance in the dark.

### Related Products

**StellaLED**  
P.308



# Optiwall



## Optiwall 1 / 2 / 3

Wall recessed

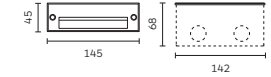
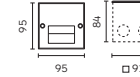
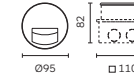
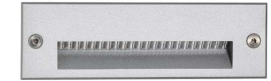
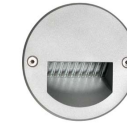

## Optiwall Stainless Steel 4 / 5 / 6

Wall recessed

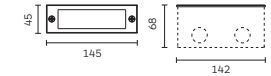
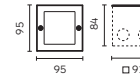
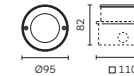

Code ordering example: **3 0 9 4 B T 1 1 - 8 0 3 0 0 0 D 0 2 9**

	Product code	Light source code*	>CRI	CCT**	LED Power	Nominal Lumen	Beam angle (BA°)	Driver Options	Finish				
Optiwall 1	<b>3094</b>	<b>BT11</b>	Lextar	SMD	<b>80</b>	<b>30</b>	3000K	1.5W	192 lm	EW (00)	<b>D0</b>	No Dim	<b>29</b> Grey (Outdoor)
					<b>40</b>	4000K			211 lm				<b>79</b> Natural Aluminium
Optiwall 2	<b>3095</b>												
Optiwall 4	<b>3097</b>												<b>89</b> Stainless Steel
Optiwall 5	<b>3098</b>												
Optiwall 3	<b>3096</b>							1.9W	256 lm				<b>29</b> Grey (Outdoor)
									282 lm				<b>79</b> Natural Aluminium
Optiwall 6	<b>3099</b>												<b>89</b> Stainless Steel

### Notes:

\* For complete code ordering information, please see page 377.

\*\* For other CCT options, please contact us.

For related accessories, please see page 374.

EW = Extra Wide. Ordering code: **00**.

# Galileo

Multi System floodlight projectors

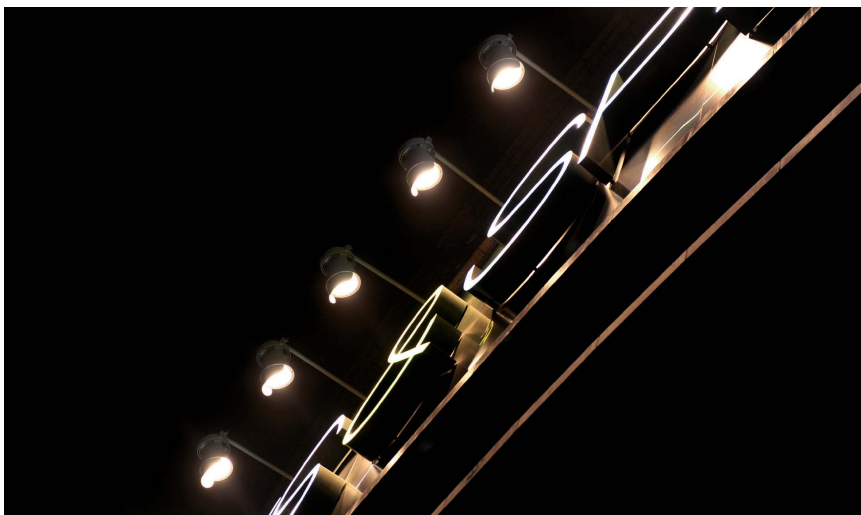

## Body

Surface floodlight in cast aluminium, with toughened safety glass, weatherproof durable silicone gasket and external screws made of stainless steel. Front cover is designed to avoid accumulation of dust and water.

Fixture available in 2 design (Galileo and Galileo Due) and different mounting options (wall, ceiling, ground, pole). Ready for electrical installation with single or double cable entries.

Galileo pole: tiltable vertically from min. 90° to max. 180°. Galileo Due: tiltable vertically 0-100° and rotatable horizontally 350°.

## Accessories

IP68 fast connector, spike, visor, pole mounted brackets.

## Finish

Superior polyester powder coat in black or grey colour.

## LED sources

Nichia single power led. CRI: 80 | CCT: 3000K, 4000K.

Other CRI and CCT options available on request.

## Optic

Lens. Medium beam angle available.

## Driver

Supplied with integrated no-dimmable driver.

Dimming Options: 0-10V Dim, DALI, Phase, CASAMBI.

## Applications

Projector-floodlight for outdoor architectural lighting; but it is also suitable for indoor area. Light emission can be directed and precisely adjusted and locked to the required angle. Application areas: subways, buildings, landmarks, billboards, sculptures, trees.

## Related Products

Galileo  
Pendant  
P.338



## Galileo Surface



### Galileo 215

Surface mounted

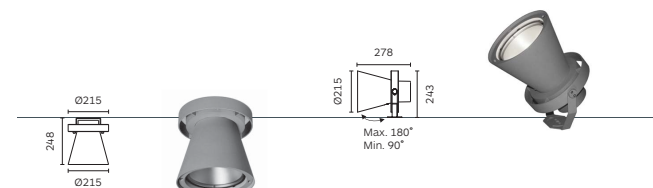

### Galileo 390

Surface mounted

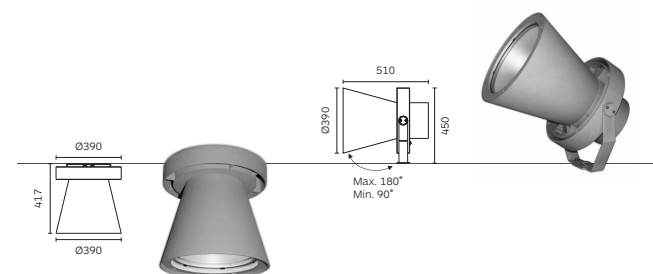

Code ordering example: **3 2 9 2 B N 1 1 - 8 0 3 0 3 1 D 0 1 0**

	Product code	Light source code	>CRI	CCT	LED Power	Nominal Lumen	Beam angle (BA°)	Driver Options	Finish
Galileo 215 Ceiling	<b>3292</b>	<b>BN11</b> Nichia 3535	<b>80</b>	<b>30</b> 3000K	23W	2622 lm	<b>31</b>	<b>D0</b> No Dim	<b>10</b> Black
				<b>40</b> 4000K		3151 lm		<b>DA</b> Dali Dim	<b>29</b> Grey (Outdoor)
Galileo 215 Pole	<b>3277</b>							<b>D1</b> 0-10 Dim	
								<b>DP</b> Phase	
Galileo 390 Ceiling	<b>3276</b>				42W	5208 lm		<b>DC</b> CASAMBI	
						6300 lm		<b>DX</b> DMX	
Galileo 390 Pole	<b>3269</b>								

### Notes:

\* For complete code ordering information, please see page 377.

\*\* For other CCT options, please contact us.

For related accessories, please see page 341.



## Galileo Surface



**Galileo 215 Up or Down / Up & Down**  
Surface mounted

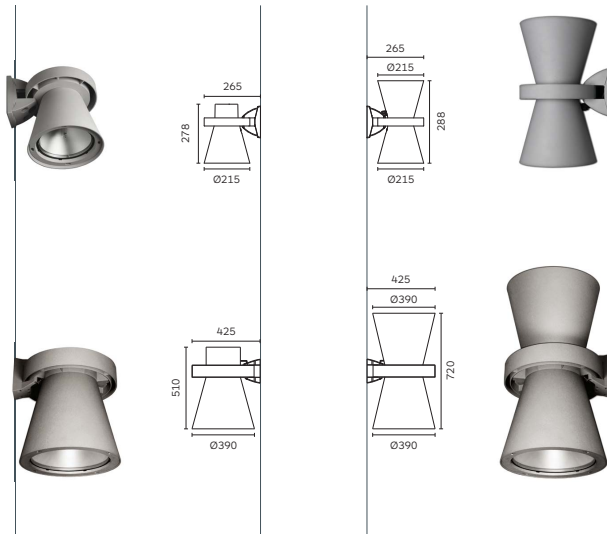

**Galileo 390 Up or Down / Up & Down**  
Surface mounted



Code ordering example: **3 3 2 8 B N 1 1 - 8 0 3 0 3 1 D 0 1 0**

	Product code	Light source code*	>CRI	CCT**	LED Power	Nominal Lumen	Beam angle (BA°)	Driver Options	Finish	
Galileo 215 Up or Down	<b>3328</b>	<b>BN11</b> Nichia	3535	<b>80</b>	<b>30</b> 3000K	23W	2622 lm	<b>31</b>	<b>D0</b> No Dim	<b>10</b> ■ Black
				<b>40</b> 4000K		3151 lm	<b>DA</b> Dali Dim	<b>29</b> ■ Grey (Outdoor)		
Galileo 215 Up & Down	<b>3333</b>				46W	5244 lm		<b>D1</b> 0-10 Dim		
Galileo 390 Up or Down	<b>3325</b>				42W	5208 lm		<b>DP</b> Phase		
						6303 lm		<b>DC</b> CASAMBI		
Galileo 390 Up or Down						6300 lm		<b>DX</b> DMX		
Galileo 390 Up & Down	<b>3331</b>									

## Notes:

- \* For complete code ordering information, please see page 377.
  - \*\* For other CCT options, please contact us.
- For related accessories, please see page 341.

## Galileo Due



**Galileo Due 215 Wall**  
Surface mounted

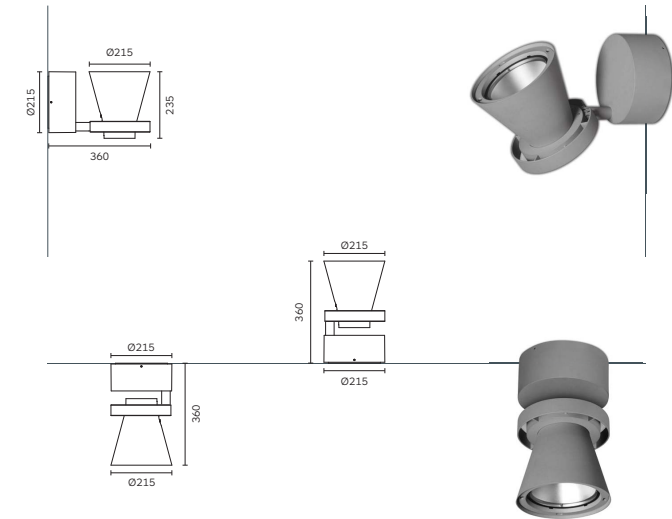

**Galileo Due 215 Ceiling/Ground**  
Surface mounted

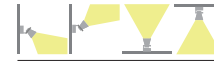

Code ordering example: **3 2 9 2 B N 1 1 - 8 0 3 0 3 1 D 0 1 0**

	Product code	Light source code*	>CRI	CCT**	LED Power	Nominal Lumen	Beam angle (BA°)	Driver Options	Finish	
Galileo Due 215 Wall	<b>3292</b>	<b>BN11</b> Nichia	3535	<b>80</b>	<b>30</b> 3000K	23W	2622 lm	<b>31</b>	<b>D0</b> No Dim	<b>10</b> ■ Black
				<b>40</b> 4000K		3151 lm	<b>DA</b> Dali Dim	<b>29</b> ■ Grey (Outdoor)		
Galileo Due 215 Ground / Ceiling	<b>3277</b>				42W	5208 lm		<b>D1</b> 0-10 Dim		
						6300 lm		<b>DP</b> Phase		
								<b>DC</b> CASAMBI		
								<b>DX</b> DMX		

## Notes:

- \* For complete code ordering information, please see page 377.
  - \*\* For other CCT options, please contact us.
- For related accessories, please see page 341.

# Galileo

Multi System floodlight projectors / Pendant



## Body

Floodlight pendant (wires or rods) projector in cast aluminium, with toughened safety glass, weatherproof durable silicone gasket and external screws made of stainless steel.

Front cover is designed to avoid accumulation of dust and water.

Fixture is available in 2 different sizes.

Electrical installation option for single or double cable entries.

Supplied with two hard wires with 2000mm cable (type H07RN-F 3x1mm).

## Accessories

IP68 fast connector.

## Finish

Superior polyester powder coat in black or grey colour.

## LED sources

Nichia single power led. CRI: 80 | CCT: 3000K, 4000K.

Other CRI and CCT options available on request.

## Related Products

Galileo Surface  
P.334



## Optic

Lens.

Medium beam angle available.

## Driver

Supplied with integrated no-dimmable driver.

Dimming Options: 0-10V Dim, DALI, Phase, CASAMBI.

## Applications

High power floodlights for LED sources with wide light distribution which makes them suitable for all architectural applications. Application areas: subways, buildings, landmarks, facades, sculptures, architectural element enhancement.

# Galileo



## Galileo 215 Up or Down / Up & Down

Pendant

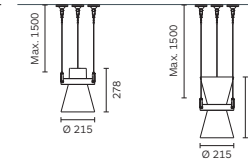

## Galileo 390 Up or Down / Up & Down

Pendant

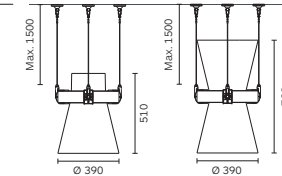

Code ordering example: 3 3 3 9 BN 11 - 80 30 31 D0 10

	Product code	Light source code*	>CRI	CCT**	LED Power	Nominal Lumen	Beam angle (BA°)	Driver Options	Finish		
Galileo 215 Pendant Up or Down	<b>3339</b>	BN11 Nichia	3535	80	30	3000K	23W	2622 lm	<b>31</b>	<b>DO</b> No Dim	<b>10</b> ■ Black
					40	4000K		3151 lm	<b>DA</b> Dali Dim	<b>29</b> ■ Grey (Outdoor)	
Galileo 215 Pendant Up & Down	<b>3343</b>						46W	5244 lm		<b>D1</b> 0-10 Dim	
								6303 lm		<b>DP</b> Phase	
Galileo 390 Pendant Up or Down	<b>3338</b>						42W	5208 lm		<b>DC</b> CASAMBI	
								6300 lm		<b>DX</b> DMX	
Galileo 390 Pendant Up & Down	<b>3341</b>						84W	10416 lm			
								12600 lm			

## Notes:

\* For complete code ordering information, please see page 377.

\*\* For other CCT options, please contact us.

For related accessories, please see page 341.

# Galileo



## Galileo 215 Up or Down / Up & Down

Pendant with rods

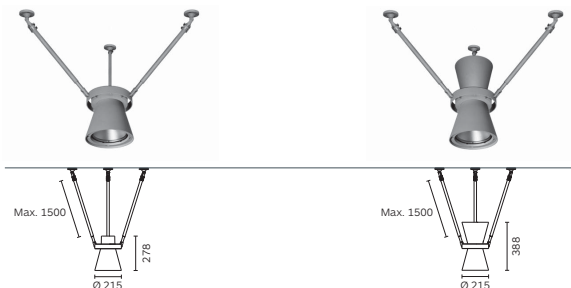

## Galileo 390 Up or Down / Up & Down

Pendant with rods

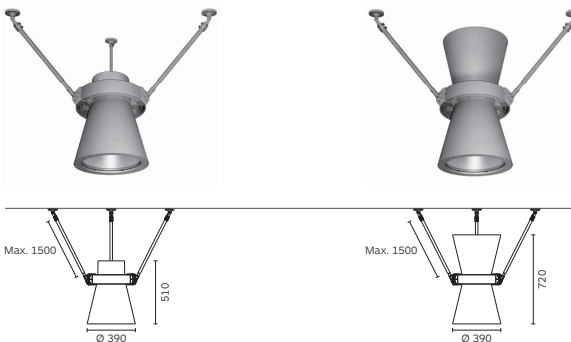

Code ordering example: **3 3 4 7 B N 1 1 - 8 0 3 0 3 1 D 0 1 0**

	Product code	Light source code*	>CRI	CCT**	LED Power	Nominal Lumen	Beam angle (BA°)	Driver Options	Finish
Galileo 215 with rods Up or Down	<b>3347</b>	<b>BN11</b> Nichia 3535	<b>80</b>	<b>30</b> 3000K	23W	2622 lm	<b>31</b>	<b>DO</b> No Dim	<b>10</b> ■ Black
				<b>40</b> 4000K		3151 lm		<b>DA</b> Dali Dim	<b>29</b> ■ Grey (Outdoor)
Galileo 215 with rods Up & Down	<b>3351</b>				46W	5244 lm		<b>D1</b> 0-10 Dim	
						6303 lm		<b>DP</b> Phase	
Galileo 390 with rods Up or Down	<b>3346</b>				42W	5208 lm		<b>DC</b> CASAMBI	
						6300 lm		<b>DX</b> DMX	
Galileo 390 with rods Up & Down	<b>3349</b>				84W	10416 lm			
						12600 lm			

**Notes:**

- \* For complete code ordering information, please see page 377.
- \*\* For other CCT options, please contact us.
- For related accessories, please see page 341.

# Accessories



**Product / Accessories**

Visor	Spike	Fast Connector M20	Pole mounted bracket set	
Available in colours 10 and 29	Available in colour 10	IP68	Available in colours 10 and 29	
	In plastic. The 50 mm upper part stay above ground level according to standards.	⌀ 6 + 12 mm	⌀ 102 mm	⌀ 120 mm
	H: 230	H: 235		

Galileo 215 Surface Ceiling / Pole	2593	/	/	2577	2509	2510
Galileo 390 Surface Ceiling / Pole	2592	/	/	2577	2509	2510
Galileo 215 Surface Up or Down / Up & Down	2593	/	/	2577	/	/
Galileo 390 Surface Up or Down / Up & Down	2592	/	/	2577	/	/
Galileo Due 215 Wall / Ground / Ceiling	2593	2322	2330	2577	/	/
Galileo 215 Pendant Up or Down / Up & Down	/	/	/	2577	/	/
Galileo 390 Pendant Up or Down / Up & Down	/	/	/	2577	/	/
Galileo 215 Pendant With rods Up or Down / Up & Down	/	/	/	2577	/	/
Galileo 390 Pendant With rods Up or Down / Up & Down	/	/	/	2577	/	/

**Notes:**

- For complete code ordering information, please see page 377.

# Disco & Gala

Wall / Ceiling luminaires



## Body

Round or square surface luminaires with body and satin opal diffuser in injection molded polycarbonate inclusive of durable silicone gasket.

External frame in cast aluminium with countersunk screws. Simple to install with 2 cable entries to facilitate through wiring and easy click system removable diffuser.

Available in 3 sizes.

## Accessories

No accessories available.

## Finish

Superior polyester powder coat in black and grey colour.

## LED sources

Samsung SMD.  
CRI: 80 | CCT: 3000K, 4000K.

Other CRI and CCT options available on request.

## Optic

Equipped with acrylic satin opal diffuser.

## Driver

Supplied with integrated no-dimmable driver.

Dimming Options: 0-10V Dim, DALI, Phase, CASAMBI.  
Emergency kit available upon request.

## Applications

Up to 685mm luminaire to provide large areas of uniform and high light output. Easy installation and maintenance due to the click system design diffuser.  
Application areas: lobbies, walkways, corridors, balconies.

## Related Products

Orbit  
P.344



# Disco & Gala



## Disco 352 / 452 / 682

Wall / Ceiling surface



## Gala 352 / 452 / 682

Wall / Ceiling surface

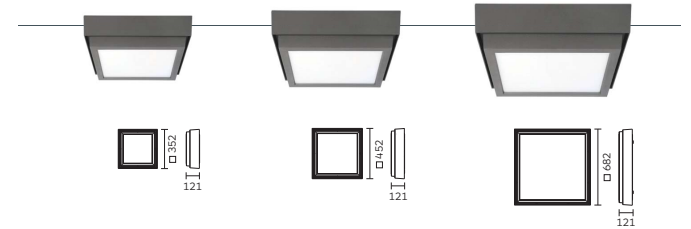

Code ordering example: **3 4 8 4 B M 1 1 - 8 0 3 0 0 0 D 0 1 0**

	Product code	Light source code*	>CRI	CCT**	LED Power	Nominal Lumen	Beam angle (BA°)	Driver Options	Finish
Disco 352	<b>3484</b>	<b>BM11</b> Samsung SMD	<b>80</b>	<b>30</b> 3000K	30W	2650 lm	EW ( <b>00</b> )	<b>D0</b> No Dim	<b>10</b> ■ Black
			<b>40</b>	4000K		2850 lm		<b>DX</b> DMX	<b>29</b> ■ Grey (Outdoor)
Gala 352	<b>3485</b>							<b>DA</b> Dali Dim	
								<b>D1</b> 0-10 Dim	
Disco 452	<b>3482</b>				45W	3800 lm		<b>DP</b> Phase	
						4000 lm		<b>DC</b> CASAMBI	
Gala 452	<b>3483</b>								
Disco 682	<b>3480</b>				80W	6800 lm			
						7100 lm			
Gala 682	<b>3481</b>								

## Notes:

\* For complete code ordering information, please see page 377.

\*\* For other CCT options, please contact us

EW = Extra Wide. Ordering code: **00**.

# Orbit

Wall / Ceiling luminaires



## Body

Round or square wall/ceiling luminaire with body in cast aluminium, inclusive of vandal resistance polycarbonate opal diffusers and weatherproof durable silicone gasket.

Countersunk external screws made of stainless steel.

Simple to install with 2 cable entries to facilitate through wiring and easy click system removable diffuser.

## LED sources

Samsung SMD.  
CRI: 80 | CCT: 3000K, 4000K.

Other CRI and CCT options available on request.

## Optic

Equipped with acrylic satin opal diffuser.

## Accessories

No accessories available.

## Finish

Superior polyester powder coat in black, white and grey colour.

## Driver

Supplied with integrated no-dimmable driver.

Dimming Options: 0-10V Dim, DALI, Phase, CASAMBI.

## Applications

Energy saving luminaire, its diffused light emission is designed to also create a halo light effect.  
Application areas: entrances, walkways, corridors, balconies, security lighting purposes.

## Related Products



# Orbit



## Orbit Round

Wall / Ceiling surface

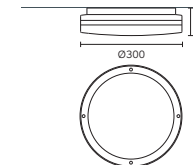

## Orbit Square

Wall / Ceiling surface

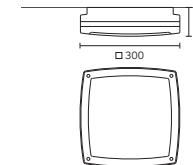

Code ordering example: **1 2 5 8 B M 1 1 - 8 0 3 0 0 0 D 0 1 0**

	Product code	Light source code*	>CRI	CCT**	LED Power	Nominal Lumen	Beam angle (BA°)	Driver Options	Finish
Orbit Round	<b>1258</b>	<b>BM11</b> Samsung SMD	<b>80</b>	<b>30</b> 3000K	32W	2560 lm	EW ( <b>00</b> )	<b>D0</b> No Dim	<b>10</b> ■ Black
				<b>40</b> 4000K		2720 lm		<b>DX</b> DMX	<b>29</b> □ Grey (Outdoor)
Orbit Square	<b>1259</b>							<b>DA</b> Dali Dim	<b>54</b> □ Sanded White
								<b>D1</b> 0 - 10 Dim	
								<b>DP</b> Phase	
								<b>DC</b> CASAMBI	

## Notes:

\* For complete code ordering information, please see page 377.

\*\* For other CCT options, please contact us.

EW = Extra Wide. Ordering code; **00**.

# Rocket

Wall / Ceiling luminaires



## Body

Round wall/ceiling luminaire with trim, light body and ring in cast aluminium.

Central housing in aluminium extrusion, with toughened safety glass, weatherproof durable silicone gasket and external screws made of stainless steel.

Front cover is designed to avoid accumulation of dust and water.

Electrical installation includes double cable entry.

Available in two sizes.

## Accessories

No accessories available.

## Finish

Superior polyester powder coat in black and grey colour.

## LED sources

Bridgelux Vero series.  
CRI: 80 | CCT: 3000K, 4000K.

Other CRI and CCT options available on request.

## Optic

Reflector. Narrow, medium and wide beam angle available.

## Driver

Supplied with integrated no-dimmable driver.

Dimming Options: 0-10V Dim, DALI, Phase, CASAMBI.

## Applications

A simple modernistic appearance makes this fixture ideal for architectural developments. Provides a personalized application and a high level of illuminance. The Up/Down version provides a special narrow beam effect. Application areas: facades, entrances, walkways, corridors, balconies.

## Related Products



# Rocket



## Rocket 111 / 150

Ceiling Surface mounted

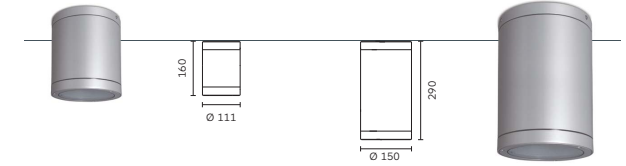

## Rocket 111 / 150

Wall Surface mounted



Code ordering example: **3 5 0 6 B B 1 2 - 8 0 3 0 1 4 D 0 1 0**

	Product code	Light source code*	>CRI	CCT**	LED Power	Nominal Lumen	Beam angle (BA°)	Driver Options	Finish
Rocket 111 Ceiling	<b>3506</b>	<b>BB12</b> Bridgelux COB	<b>80</b>	<b>30</b> 3000K	14W	2152 lm	<b>14 / 22 / 32</b>	<b>D0</b> No Dim	<b>10</b> ■ Black
				<b>40</b> 4000K		2220 lm		<b>DX</b> DMX	<b>29</b> ■ Grey (Outdoor)
Rocket 111 Wall	<b>3504</b>				2 x 14W	4304 lm		<b>DA</b> Dali Dim	
						4440 lm		<b>D1</b> 0-10 Dim	
Rocket 150 Ceiling	<b>3505</b>	<b>BB13</b> Bridgelux COB			20W	3067 lm	<b>16 / 28 / 40</b>	<b>DP</b> Phase	
						3170 lm		<b>DC</b> CASAMBI	
Rocket 150 Wall	<b>3503</b>				2 x 20W	5134 lm			
						6340 lm			

## Notes:

\* For complete code ordering information, please see page 377.

\*\* For other CCT options, please contact us.

# Forlinea

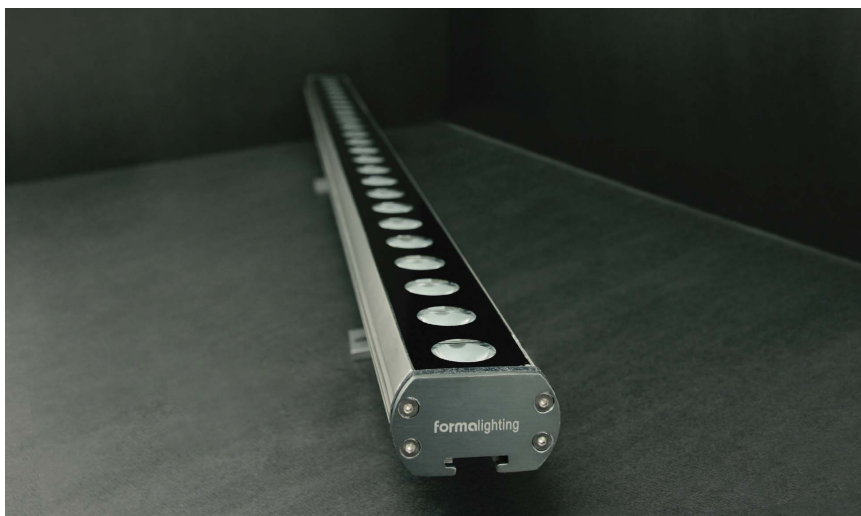

## Body

Linear surface mounted wallwasher with luminaire housing in aluminium extrusion.

End caps and mounting brackets in cast aluminium.

Product inclusive of toughened silk screened tempered glass.

Front cover in hinged aluminium frame designed to avoid accumulation of dust and water.

Easy electrical installation via the included hard wire rubber cable.

## Accessories

Louvres, mounting brackets, Antiglare louvre, antiglare shield.

## Finish

Powder coat in stainless steel colour.

## LED sources

Nichia or Cree single power led. CRI: 90 | CCT: 3000K, 4000K.

Other CRI and CCT options, TuneableWhite and RGB/W versions available on request.

## Optic

Lens.

Narrow, medium and wide beam angle available.

## Driver

Supplied with remote no-dimmable or DMX driver. Dimming Options: DMX, DALI.

## Applications

A stylish designed outdoor linear wallwasher offering the possibility to easy connect many unit. The Pro version can create marvellous lighting effects thanks to its series of louvre. Application areas: facades, billboards, sculptures, art installations, pathways, playgrounds, town squares.

## Related Products

Frontluce  
P.352



# Forlinea



## Forlinea

Surface mounted

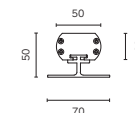
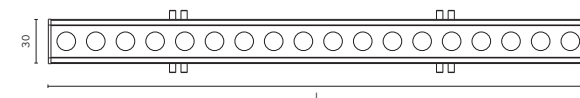

+/- 140° Adjustability



Code ordering example: **3 5 8 5 BN 1 1 - 9 0 3 0 1 0 D 0 8 4**

	Product code	Light source code*	Length (L)	>CRI	CCT**	LED Power	Nominal Lumen	Beam angle (BA°)	Driver Options	Finish
Forlinea 200	<b>3585</b>	<b>BN11</b> Nichia 3535	200	<b>90</b>	<b>30</b> 3000K	6W	510 lm	<b>10/30/AS</b>	<b>D0</b> No Dim	<b>84</b> Stainless Steel
					<b>40</b> 4000K	528 lm				
Forlinea 400	<b>3586</b>		400		<b>27</b> 2700K	12W	1020 lm		<b>DX</b> DMX	
					<b>30</b> 3000K	1056 lm				
Forlinea 600	<b>3587</b>		600			18W	1530 lm		<b>DA</b> Dali Dim	
						1584 lm				
Forlinea 1200	<b>3588</b>		1200			36W	3060 lm			
						3168 lm				

## Notes:

\* For complete code ordering information, please see page 377.

\*\* For other CCT options, please contact us.

For related accessories, please see page 351.

# Forlinea Pro



**Forlinea Pro**  
Surface mounted

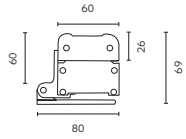

+70° Adjustability



Code ordering example: **3 5 8 9 B N 1 1 - 9 0 3 0 1 0 D 0 8 4**

	Product code	Light source code*	Length (L)	>CRI	CCT**	LED Power	Nominal Lumen	Beam angle (BA°)	Driver Options	Finish
Forlinea Pro 300	<b>3589</b>	<b>BN11</b> Nichia 3535	300	<b>90</b>	<b>30</b> 3000K	12W	1020 lm	<b>10/30/AS</b>	<b>D0</b> No Dim	<b>84</b> Stainless Steel
					<b>40</b> 4000K		1056 lm	<b>DX</b> DMX		
Forlinea Pro 600	<b>3590</b>		600		<b>27</b> 2700K	24W	2016 lm		<b>DA</b> Dali Dim	
					<b>30</b> 3000K		2112 lm			
Forlinea Pro 1200	<b>3591</b>		1200			48W	4080 lm			
							4220 lm			
				<b>RG</b>	<b>B0</b>	/	/	<b>00</b>	<b>DX</b> DMX	
					<b>BW</b>					

**Notes:**  
\* For complete code ordering information, please see page 377.  
\*\* For other CCT options, please contact us.  
For related accessories, please see page 351.

# Accessories



Product / Accessories	T joint power cable	Female lead in power cable	Male lead in power cable	Female lead in power & signal cable	Male lead in power & signal cable
	3 Pin	6 Pin	L: 300 mm 3 pin	L: 300 mm 6 pin	L: 300 mm 6 pin
<b>Forlinea</b>	<b>2C23</b>	<b>2C43</b>	<b>2C24</b>	<b>2C25</b>	<b>2C26</b>
<b>Forlinea Pro</b>					<b>2C27</b>



Product / Accessories	Cable joint male	Adjustable flip-flop mounting bracket	Adjustable mounting bracket	Anti-glare shield
	3 pin, Max 2.5 mm cable			L:300 L:600 L:1200
<b>Forlinea</b>	<b>2C28</b>	<b>2C29</b>	<b>2C30</b>	/ / /
<b>Forlinea Pro</b>				<b>2C31</b> <b>2C41</b> <b>2C42</b>



Product / Accessories	Anti-glare louver					
	Symmetric			Asymmetric		
	L:300	L:600	L:1200	L:300	L:600	L:1200
<b>Forlinea</b>	/	/	/	/	/	/
<b>Forlinea Pro</b>	<b>2C32</b>	<b>2C37</b>	<b>2C38</b>	<b>2C33</b>	<b>2C39</b>	<b>2C40</b>

**Notes:**  
For complete code ordering information, please see page 377.



# Fronteluce 90

Multi system linear projector



## Body

Linear projector with light housing in aluminium extrusion. End caps and mounting brackets in cast aluminium.

Product inclusive of toughened safety glass, weatherproof durable silicone gasket, breather device and external screws made of stainless steel.

Front cover in hinged aluminium frame designed to avoid accumulation of dust and water.

Electrical installation includes double cable entry. Available in two sizes.

Light adjustable vertically up to 195° and horizontally 0-35°.

## Accessories

Mounting brackets, suspension set, pole mounted bracket sets, wall sets, billboard sets, IP68 fast connector, IP65 extension cable.

## Finish

Superior polyester powder coat in grey colour.

## LED sources

Nichia single power led; Lextar SMD. CRI: 80 | CCT: 3000K, 4000K.RGB/W, TuneableWhite.

Other CRI and CCT options available on request.

## Optic

Frosted glass diffuser or lens, according with the chosen model.

## Driver

Supplied with integrated no-dimmable driver. Dimming Options: 0-10V Dim, DALI, Phase, CASAMBI.

## Applications

Extremely compact linear luminaire offering minimal visual impact and huge flexibility. A vast range of accessories makes possible to mount it in many different way (ground, ceiling, wall, pole). Application areas: facades, under canopy areas, billboards, sculptures, art installations.

### Related Products

Forlinea  
P.348

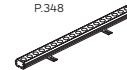

# Fronteluce 90

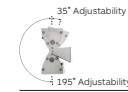
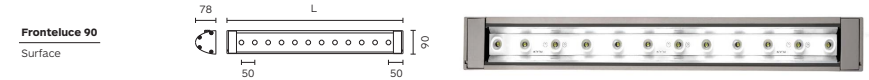

Code ordering example: **3 1 9 8 B N 1 1 - 8 0 3 0 2 5 D 0 2 9**

	Product code	Light source code*	Length (L)	>CRI	CCT**	LED Power	Nominal Lumen	Beam angle (BA°)	Driver Options	Finish
Fronteluce 90	<b>3198</b>	<b>BN11</b> Nichia	3535	600	<b>80</b>	<b>30</b> 3000K	12 x 3W 1500 lm	<b>25</b>	<b>D0</b> No Dim	<b>29</b> Grey (Outdoor)
			600	<b>40</b> 4000K	1800 lm	<b>DX</b> DMX				
	<b>3199</b>		900			18 x 3W 2250 lm		<b>DA</b> Dali Dim		
			1200			2700 lm		<b>D1</b> 0-10 Dim		
	<b>3200</b>						24 x 3W 3000 lm		<b>DP</b> Phase	
							3600 lm		<b>DC</b> CASAMBI	
					<b>TW TW</b> 1800K to 6000K	12 x 3W /	<b>00</b>	<b>DX</b> DMX		
					<b>RG B0</b>	/		<b>DC</b> CASAMBI		
Fronteluce 90 Opal diffuser	<b>3486</b>	<b>BT11</b> Lextar SMD	600	<b>80</b>	<b>30</b> 3000K	40W 2400 lm	<b>EW (00)</b>	<b>D0</b> No Dim		
			900	<b>40</b> 4000K	2600 lm	<b>DX</b> DMX				
	<b>3487</b>					60W 3600 lm		<b>DA</b> Dali Dim		
						3900 lm		<b>D1</b> 0-10 Dim		
<b>3488</b>						80W 4800 lm		<b>DP</b> Phase		
						5200 lm		<b>DC</b> CASAMBI		

### Notes:

\* For complete code ordering information, please see page 377.

\*\* For other CCT options, please contact us.

For related accessories, please see page 354-355.

EW = Extra Wide. Ordering code: **00**.

## Accessories



Product / Accessories	Mounting brackets	Mounting brackets	Mounting brackets	Suspension set
	Available in colour 29	Available in colour 29	Available in colour 29	Available in colour 29
	2 pcs. adjustable.	2 pcs. adjustable.	2 pcs. adjustable and extendible.	2pcs. 1500mm wire hangers and one power supply cable.
<b>Fronteluce 90</b>	<b>2379</b>	<b>2380</b>	<b>2381</b>	<b>2382</b>

**Fronteluce 90 Opal diffuser**

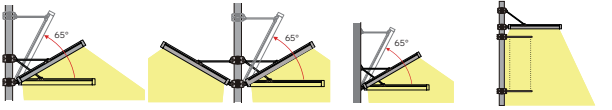
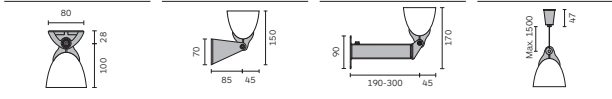

Product / Accessories	Pole mounted bracket set	Pole mounted bracket set	Wall mounted set	Billboard set
	Available in colour 29	Available in colour 29	Available in colour 29	Available in colour 29
	Ø 102 mm    Ø 120 mm For one fixture	Ø 102 mm    Ø 120 mm For two fixtures		For one banner
<b>Fronteluce 90</b>	<b>2394</b> <b>2395</b>	<b>2565</b> <b>2566</b>	<b>2567</b>	<b>2568</b> <b>2569</b>

**Fronteluce 90 Opal diffuser**

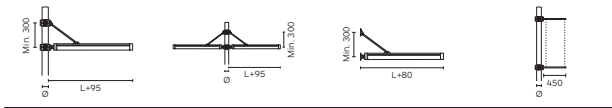

**Notes:**  
For complete code ordering information, please see page 377.

## Accessories

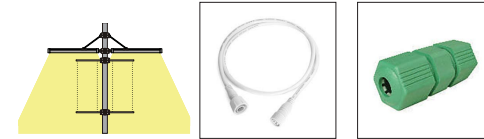

Product / Accessories	Billboard set	Extension signal cable	Fast connector M20
	Available in colour 29	L: 1000    L: 2000	IP68
	Ø 102 mm    Ø 120 mm suitable for two banners.	For RGB with M/F connectors.	⊕ 6 + 12 mm)
<b>Fronteluce 90</b>	<b>2570</b> <b>2571</b>	<b>2478</b> <b>2479</b>	<b>2577</b>

**Fronteluce 90 Opal diffuser**

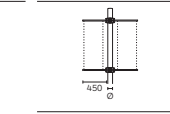

**Notes:**  
For complete code ordering information, please see page 377.

# Continuo

Ground / Wall recessed linear seamless luminaires



## Body

Recessed linear seamless luminaire with light housing in corrosion resistant extruded aluminium.

Diffuser with special toughened glue designed to eliminate Led dots.

Pre-installation box in cast aluminium or optionally in stainless steel.

Linkable inline connection via IP68 male and female connectors.

## LED sources

Lextar SMD LED.  
CRI: 80 | CCT: 3000K, 4000K.

Other CRI and CCT options available on request.

## Optic

Satin opal acrylic diffuser.

## Related Products

**Terraluce  
Linear**  
P.304



## Accessories

No accessories available.

## Finish

Powder coat in white or grey colour.

## Driver

Supplied with integrated no-dimmable driver.  
Dimming Options (available only with remote driver): 0-10V Dim, DALI Phase, CASAMBI.

## Applications

Linear seamless LED recessed in-ground fixture, for individual or continuous row installation black spot free. Including linking point and special diffuser to eliminate LED dots. Application areas: buildings pathways, public areas, sidewalks, landmark facade, architectural enhancement.

# Continuo



**Continuo**  
Ground / Wall recessed

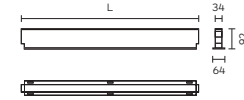

Code ordering example: 3 5 6 2 B T 1 1 - 80 30 00 D0 79

	Product code	Light source code*	Length (L)	>CRI	CCT**	LED Power	Nominal Lumen	Beam angle (BA°)	Driver Options	Finish
Continuo 500	<b>3562</b>	<b>BT11</b> Lextar SMD	500	<b>80</b>	<b>30</b> 3000K <b>40</b> 4000K	8W	175 lm 184 lm	<b>EW (00)</b>	<b>D0</b> No Dim <b>DX</b> DMX	<b>79</b> Natural aluminium
Continuo 1000	<b>3550</b>		1000			16W	325 lm 340 lm		<b>DA</b> Dali Dim <b>D1</b> 0-10 Dim <b>DP</b> Phase <b>DC</b> CASAMBI	

## Notes:

\* For complete code ordering information, please see page 377.

\*\* For other CCT options, please contact us.

EW = Extra Wide. Ordering code: **00**.

# Astra

Surface mounted light effect luminaire



## Body

Surface mounted luminaire with body in cast aluminium, inclusive of toughened thermal shock glass diffuser or focused glass lens, weatherproof durable silicone gasket and external screws made of stainless steel.

Front cover is designed to avoid accumulation of dust and water.

Simple to install with 2 cable entries to facilitate through wiring.

## Accessories

Available Pole mounted bracket set.

## Finish

Superior polyester powder coat in black and grey colour.

## LED sources

Bridgelux Vero series.  
CRI: 90 | CCT: 3000K, 4000K.

Other CRI and CCT options available on request.

## Optic

Reflector in metalized PC or glass convex lens.  
Narrow lens available.

## Driver

Supplied with integrated no-dimmable driver.  
Dimming Options: 0-10V Dim, DALI, Phase, CASAMBI.

## Applications

Its simple modern design makes it ideal for today architectural developments. Up/Down version offers special narrow beam light effect, while the floodlight asymmetric version providing high illuminance. Application areas: façades, entrances, walkways.

## Related Products



## Astra Up & Down



### Astra Up & Down

Surface mounted

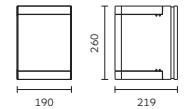

Code ordering example: **3 5 3 3 B B 1 2 - 9 0 3 0 6 0 D 0 1 0**

	Product code	Light source code*	>CRI	CCT**	LED Power		Nominal Lumen	Beam angle (BA°)	Driver Options	Finish
					Up & Down	Up & Down				
Astra Up & Down Wide	<b>3533</b>	<b>BB12 Bridgelux COB</b>	<b>90</b>	<b>30</b> 3000K	2 x 16W	4530 lm	<b>60 / 60</b>	<b>D0</b> No Dim	<b>10</b> ■ Black	
				<b>40</b> 4000K		5068 lm		<b>DX</b> DMX	<b>29</b> ■ Grey	
Astra Up & Down Wide / Narrow	<b>3557</b>						<b>08 / 60</b>	<b>DA</b> Dali Dim		
Astra Up & Down Narrow	<b>3558</b>							<b>D1</b> 0-10 Dim		
Astra Up & Down Walwasher	<b>3560</b>							<b>DP</b> Phase		
								<b>DC</b> CASAMBI		
							<b>WW</b>			

### Notes:

\* For complete code ordering information, please see page 377.

\*\* For other CCT options, please contact us.

For related accessories, please see page 361.

# Astra Up or Down



**Astra Up or Down**  
Surface mounted

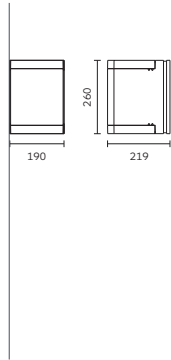

Code ordering example: **3 5 5 6 B B 1 2 - 90 30 60 D 0 1 0**

	Product code	Light source code*	>CRI	CCT**	LED Power	Nominal Lumen	Beam angle (BA°)	Driver Options	Finish
					Up or Down	Up or Down			
Astra Up or Down Wide	<b>3556</b>	<b>BB12 Bridgelux COB</b>	<b>90</b>	<b>30</b> 3000K	22W	2941 lm	<b>60</b>	<b>D0</b> No Dim	<b>10</b> ■ Black
				<b>40</b> 4000K		3042 lm		<b>DX</b> DMX	<b>29</b> ■ Grey
Astra Up or Down Narrow	<b>3559</b>						<b>08</b>	<b>DA</b> Dali Dim	
								<b>D1</b> 0-10 Dim	
Astra Up or Down Wallwasher	<b>3561</b>						<b>WW</b>	<b>DP</b> Phase	
								<b>DC</b> CASAMBI	

**Notes:**  
\* For complete code ordering information, please see page 377.  
\*\* For other CCT options, please contact us.  
For related accessories, please see page 361.

# Accessories



Product / Accessories	Pole mounted bracket set		Pole mounted bracket set	
	Ø 102 mm	Ø 120 mm	Ø 102 mm	Ø 120 mm
<b>Astra Up &amp; Down</b>	<b>2508</b>	<b>2507</b>	<b>2563</b>	<b>2564</b>
<b>Astra Up or Down</b>	With connector for one fixture. Available in colours 10 and 29.		With connector for two fixtures. Available in colours 10 and 29.	

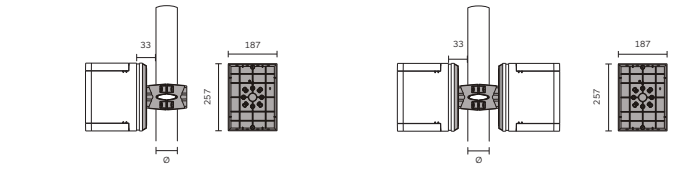

**Notes:**  
For complete code ordering information, please see page 377.

# Edge

Surface mounted luminaire for window sill



## Body

Surface mounted luminaire for window sill. Body and mounting plate in cast aluminium, with toughened safety glass molded in weatherproof silicone gasket and screws made of stainless steel.

Designed to avoid accumulation of dust and water. Easy installation via mounting plate and hard wire 500mm cable type H07-RN-F 2x1.0mm included.

Ingress protection 65.

## Accessories

No accessories available.

## Finish

Superior polyester powder coat in grey colour.

## LED sources

Nichia Power LED.  
CRI: 80 | CCT: 3000K, 4000K.

Other CRI and CCT options available on request.

## Optic

Optical asymmetric light beam distribution via 2 lens made of optical polymer.

## Driver

Supplied with integrated no-dimmable driver.

## Applications

Designed to light up facade windows reveals, doorways or shop windows, with a unique optical lens system from 2 Leds, light is thrown from the two sides of the luminaire to the opposite surfaces. Application areas: window lighting, building facades, landscape lighting.



# Edge



Edge

Surface mounted

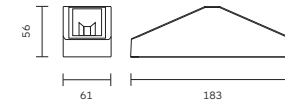

Code ordering example: **3 5 4 8 B N 1 1 - 8 0 3 0 0 0 D 0 2 9**

	Product code	Light source code*	>CRI	CCT**	LED Power	Nominal Lumen	Beam angle (BA°)	Driver Options	Finish	
Edge	<b>3548</b>	<b>BN11</b> Nichia	LED	<b>80</b>	<b>30</b> 3000K	2 x 3W	175 lm	<b>EW (00)</b>	<b>D0</b> No Dim	<b>29</b> Grey (Outdoor)
				<b>40</b> 4000K			185 lm			

### Notes:

\* For complete code ordering information, please see page 377.

\*\* For other CCT options, please contact us.

EW = Extra Wide. Ordering code: **00**.

# Polo

Accent spotlight

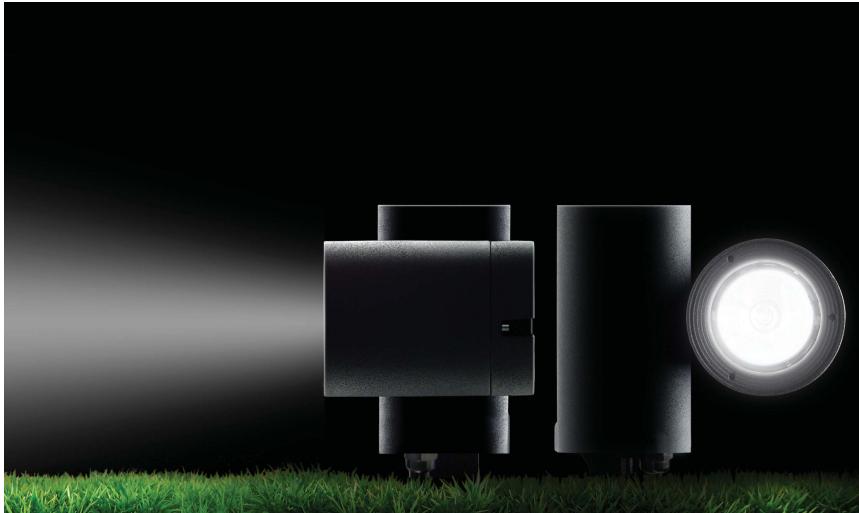

## Body

Accent spotlight with body and driver housing in cast aluminium, inclusive of toughened safety glass, weatherproof durable silicone gasket and external screws in stainless steel.

Front cover is designed to avoid accumulation of dust and water.

Fixture is available in 2 different sizes.  
PG7 cable entry.  
Tilttable vertically 0-180° and routable horizontally 0-350°.

## Accessories

Protective grill, visor, spikes.

## Finish

Superior polyester powder coat in black and grey colour.

## LED sources

Bridgelux COB series.  
CRI: 90 | CCT: 3000K, 4000K.

Other CRI and CCT options available on request.

## Optic

Reflector for Polo 68.  
Lens for Polo 35.  
Narrow, medium and wide beam angle available.

## Driver

Supplied with integrated no-dimmable driver.

## Applications

The visor glare shield cap or the protective grill help to protect the environment from unpleasant bright light. The earth spike is for portable or temporary use. Application areas: trees, landscapes, gardens, golf courses, pathways, billboards, sculptures.

## Related Products

Bullet  
P.324



# Polo



## Polo 35 / Polo 68

Surface mounted

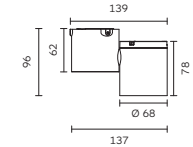
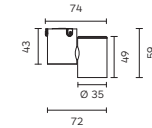

Code ordering example: **3 1 3 9 B N 1 1 - 9 0 3 0 1 5 D 0 1 0**

	Product code	Light source code*	Nichia	3535	>CRI	CCT**	LED Power	Nominal Lumen	Beam angle (BA°)	Driver Options	Finish
Polo 35	<b>3139</b>	<b>BN11</b>			<b>90</b>	<b>30</b> 3000K	3W	65 lm	<b>15</b>	<b>D0</b> No Dim	<b>10</b> ■ Black
						<b>40</b> 4000K		80 lm			<b>29</b> ■ Grey
Polo 68	<b>3510</b>	<b>BB22</b>	Bridgelux COB				11W	800 lm	<b>20 / 26 / 40</b>		
								890 lm			

## Notes:

\* For complete code ordering information, please see page 377.

\*\* For other CCT options, please contact us.

For related accessories, please see page 374.

# Visor

Wall mounted grazing light



## Body

Wall mounted grazing light with light body and adjustable visor in cast aluminium.

Diffuser in tempered safety glass. Inclusive of molded silicone gasket and stainless steel screws.

Designed for longitudinal uplighting and or downlighting. Ingress protection 54.

Adjustable Visor able to rotate 270° around the fixture.

## LED sources

Samsung SMD LED.

CRI: 80 | CCT: 3000K, 4000K.  
Other CRI and CCT options available on request.

## Optic

Visor in cast aluminium.

## Accessories

No accessories available.

## Finish

Superior polyester powder coat in grey colour.

## Driver

Supplied with integrated no-dimmable driver.

## Applications

An extremely compact outdoor wall luminaire with adjustable visor with joint to direct the light where is required, specially designed for longitudinal uplighting and or downlighting. Application areas: doorways entrances, corridors, walkways, gatepost, columns.

## Related Products

**Rocket**  
P.346



# Visor



**Visor**  
Wall mounted

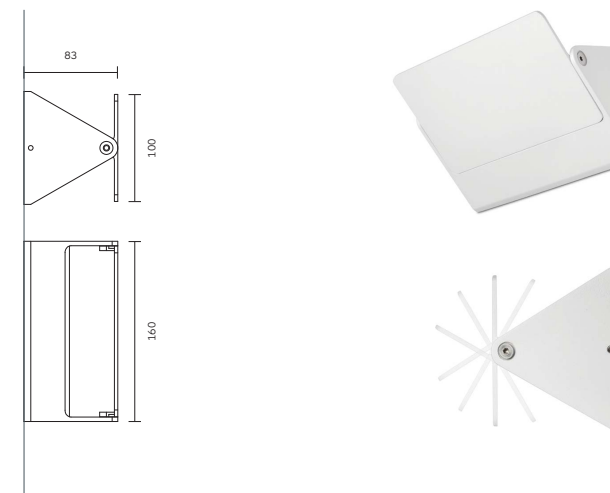

Code ordering example: **3 5 4 7 B T 1 1 - 8 0 3 0 0 0 D 0 2 9**

	Product code	Light source code*		>CRI	CCT**	LED Power	Nominal Lumen	Beam angle (BA°)	Driver Options	Finish
Visor	<b>3547</b>	<b>BT11</b>	Samsung SMD	<b>80</b>	<b>30</b> 3000K	8W	80 lm	<b>EW (00)</b>	<b>D0</b> No Dim	<b>29</b> Grey (Outdoor)
					<b>40</b> 4000K		85 lm			

## Notes:

\* For complete code ordering information, please see page 377.

\*\* For other CCT options, please contact us.

EW = Extra Wide. Ordering code: **00**.



# Arco

Wall mounted grazing light



## Body

Surface mounted grazing light with body is made in cast aluminium, flush toughened thermal shock clear glass diffuser, weatherproof durable silicone gasket and external screws made of stainless steel.

Simple to install via cable entry. Usable as a upwards or downwards luminaire.

## LED sources

Lextar SMD LED.  
CRI: 80 | CCT: 3000K, 4000K.

Other CRI and CCT options available on request.

## Related Products



## Optic

Opal difuser. Wide angle available

## Accessories

No accessories available.

## Driver

Supplied with integrated no-dimmable driver.

## Finish

Superior polyester powder coat in black and grey colour.

## Applications

Wall or ceiling mounted luminaire of timeless shape design and can be fit with the light flowing upwards or downwards. Application areas: entrances, corridors, walkways, terraces.

# Arco



**Arco Up or down**  
Surface mounted

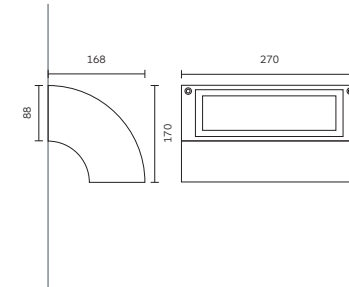

Code ordering example: **3 4 7 6 B T 1 1 - 8 0 3 0 0 0 D 0 1 0**

	Product code	Light source code*		>CRI	CCT**	LED Power	Nominal Lumen	Beam angle (BA°)	Driver Options	Finish		
Arco	<b>3476</b>	<b>BT11</b>	Lextar	SMD	<b>80</b>	<b>30</b>	3000K	10W	600 lm	EW ( <b>00</b> )	<b>D0</b> No Dim	<b>10</b> ■ Black
Up or Down					<b>40</b>	4000K		650 lm			<b>DX</b> DMX	<b>29</b> ■ Grey (Outdoor)
											<b>DA</b> Dali Dim	
											<b>D1</b> 0-10 Dim	
											<b>DP</b> Phase	
											<b>DC</b> CASAMBI	

## Notes:

\* For complete code ordering information, please see page 377.

\*\* For other CCT options, please contact us.

EW = Extra Wide. Ordering code: **00**.

# Cubox

Wall mounted grazing light



## Body

Wall mounted light with body in cast aluminium, toughened thermal shock clear glass diffusers, weatherproof durable silicone gasket and external screws made of stainless steel. Simple to install via cable entry.

Ingress Protection 54.

## LED sources

Nichia single power led. CRI: 80 | CCT: 3000K, 4000K. Other CRI and CCT options available on request.

## Related Products

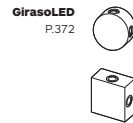

## Optic

Available in Dual light emission with also narrow beam upward or with single light emission.

## Accessories

For related accessories, please see page 374.

## Driver

Supplied with integrated no-dimmable driver.  
Dimming Options: 0-10V Dim, DALI, Phase, CASAMBI.

## Finish

Superior polyester powder coat in black and grey colour.

## Applications

Fixture in shape of a cube with Dual lights emission; it is available also with option of narrow beam upward. Application areas: entrances, corridors, walkways, gateposts, columns.

# Cubox



## Cubox S2 (2slots) / SG / G2

Wall mounted

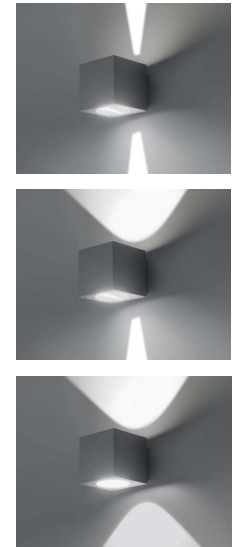
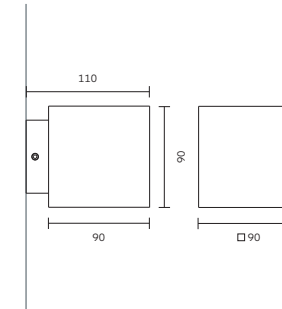

Code ordering example: **3 4 7 4 B R 1 1 - 8 0 3 0 1 5 D 0 1 0**

	Product code	Light source code*	>CRI	CCT**	LED Power	Nominal Lumen	Beam angle (BA°)	Driver Options	Finish	
					Up & Down	Up & Down				
Cubox S2 (2 slots)	<b>3474</b>	<b>BR11 Cree</b>	<b>3535</b>	<b>80</b>	<b>30</b> 3000K	2 x 3W	70 lm	<b>15</b>	<b>D0</b> No Dim	<b>10</b> ■ Black
					<b>40</b> 4000K		80 lm			<b>29</b> ■ Grey
Cubox SG	<b>3414</b>						<b>99 / 15</b>			
Cubox G2	<b>3415</b>						<b>99</b>			

## Notes:

\* For complete code ordering information, please see page 377.

\*\* For other CCT options, please contact us.

For related accessories, please see page 374.

# GirasoLED

Surface mounted grazing light

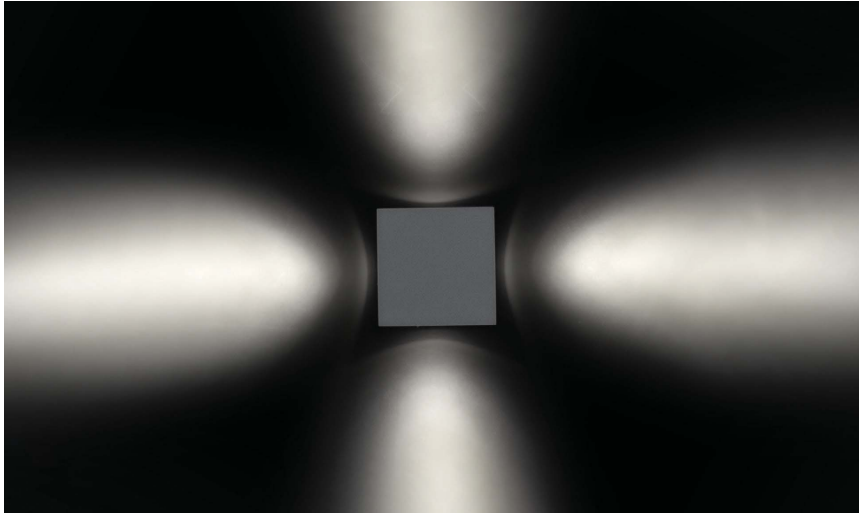

## Body

Surface mounted light with body in cast aluminium, toughened thermal shock clear glass diffusers, weatherproof durable silicone gasket and external screws made of stainless steel.

Simple to install via cable entry with grommet. Can be connected directly to the main power.

Available in 2 versions - Round and Square.

## LED sources

Nichia single power led. CRI: 80 | CCT: 3000K, 4000K. Other CRI and CCT options available on request.

## Related Products



## Optic

Lens.  
Narrow beam angle available.

## Accessories

No accessories available.

## Driver

Supplied with integrated no-dimmable driver.

## Finish

Superior polyester powder coat in black and grey colour.

## Applications

Its simple modernistic appearance making it ideal for today's architectural developments. It gives a high performance personalized lighting effect with minimal costs. Application areas: safety and security, facades, entrances, walkways, corridors.

# GirasoLED



## GirasoLED Round & Square

Surface mounted

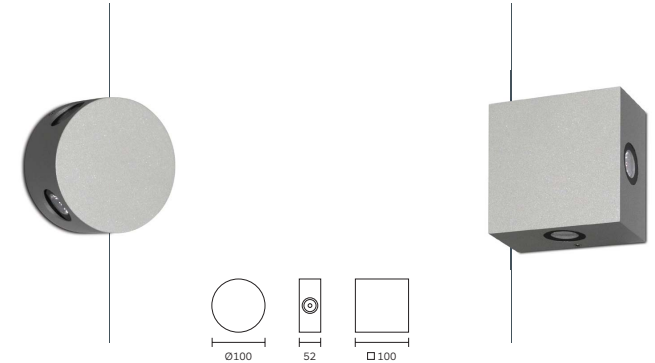

Code ordering example: **3 4 1 9 B N 1 1 - 8 0 3 0 1 0 D 0 1 0**

	Product code	Light source code*	>CRI	CCT**	LED Power	Nominal Lumen	Beam angle (BA°)	Driver Options	Finish
GirasoLED Round	<b>3419</b>	<b>BN11</b> Nichia 3535	<b>80</b>	<b>30</b> 3000K	4W	60 lm	<b>10</b>	<b>D0</b> No Dim	<b>10</b> ■ Black
GirasoLED Square	<b>3418</b>			<b>40</b> 4000K		68 lm			<b>29</b> ■ Grey

## Notes:

\* For complete code ordering information, please see page 377.

\*\* For other CCT options, please contact us.

## Accessories



Product / Accessories	Anchor Bolt Kit	Anchor Bolt Kit	Fast connector M20	3-Way Junction Box	Slot 1
	In steel	In steel	IP68	IP68	Available in colour 79

To ditch in concrete.

To ditch in concrete.

⌀ 6 + 12 mm)  
Connection must be done inside an accessible box.

2 set of gasket rings included suitable for wide range of cable diameters:

⌀5 - ⌀8 mm)

⌀8 - ⌀14 mm)

<b>Trafo</b>	<b>2231</b>	/	/	/	/
<b>Cornetto</b>	/	<b>2601</b>	/	/	/
<b>Optiwall</b>	/	/	<b>2577</b>	<b>2355</b>	/
<b>Cubox</b>	/	/	/	/	<b>2064</b>
<b>Corolla</b>	<b>2601</b>	/	/	/	/
<b>Scudo Wall</b>	/	/	<b>2577</b>	/	/



Product / Accessories	Protective Grill	Visor	Spike	Spike	Pole mounted bracket set
	Available in colours 10 and 29	Available in colours 10 and 29	Available in colour 10	Available in colour 10	Available in colours 10, 29

In die cast aluminium.

In die cast aluminium.

The 50 mm upper part must stay above ground level according to standards.

In plastic.  
The 50 mm upper part must stay above ground level according to standards.



H: 223 mm

H: 220 mm

Ø120 mm

<b>Polo</b>	<b>2375</b>	<b>2378</b>	/	<b>2372</b> <b>2373</b>	/	/	/
<b>FioreLED</b> Rectangular base	/	/	<b>2330</b>	/	/	<b>2652</b>	/
<b>FioreLED</b> Round base	/	/	/	/	/	/	/
<b>Scudo Wall</b>	/	/	/	/	/	<b>2509</b>	<b>2510</b>

### Notes:

For complete code ordering information, please see page 377.

## Symbols & Icons

## Code system

## Quick product search

## Global presence

## Symbols & Icons

Trim Round	
Trim Square	
Trimless Round	
Trimless Square	
Round ceiling cut	
Square ceiling cut	

The CE mark signifies that a product conforms with the relevant ECC directives requirements. The CE marking is compulsory to indicate LVD and EMC conformity.

The CE mark is also a self certification that the manufacturer claims that the product is safe. The value of such claim is directly related to the case of FormaLighting: All products are designed, developed, manufactured under the scope of ISO 9001 quality systems.



All formLighting products are tested in Europe and certified by an independent laboratory that is registered and audited by an approved European testing authority.

### Others third party product approvals

Our products include electrical and electronic components that carry other world wide Test House approvals such as those shown:



### CLASS I

Luminaires of insulation Class I - with earth connector.



### CLASS II

Luminaires of insulation Class II - With safety isolation, this means the tension conduction element are protected by additional isolation.

The isolation of an earth wire it is not necessary and the connection to it is not allowed.



### CLASS III

Luminaires of insulation Class III - designed for operation of protected low voltage supply (142V).



Passes the 850C glow wire test in accordance with ICE 695-2-1.



Passes the 960C glow wire test in accordance with ICE 695-2-1.



Degree of Ingress Protection\*



Dim2Warm



Tuneable White



Recyclable



## IP\_\_ Degree of Ingress Protection

1st Number	Protection Against Dust and Solid Objects	2nd Number	Protection Against Moisture and Liquids
0	No-Protection	0	No-Protection
1	Protection against solid objects >50 mm	1	Protection against dripping water
2	Protection against solid objects >12 mm	2	Protection against dripping water tilted > 15 deg
3	Protection against solid objects >2.5 mm	3	Protection against spraying water > 30 deg
4	Protection against solid objects >1 mm	4	Protection against spraying water
5	Dust - protected	5	Protection against water jet
6	Dust - tight	6	Protection against waves
		7	Protection against the effects of immersion
		8	Protection against submersion

## Level of Shock Resistance

IK00	Not protected	IK00
IK01	Protected against 0.15 J shocks	IK01
IK02	Protected against 0.2 J shocks	IK02
IK03	Protected against 0.35 J shocks	IK03
IK04	Protected against 0.5 J shocks	IK04
IK05	Protected against 0.7 J shocks	IK05
IK06	Protected against 1 J shocks	IK06
IK07	Protected against 2 J shocks	IK07
IK08	Protected against 5 J shocks	IK08
IK09	Protected against 10 J shocks	IK09
IK10	Protected against 20 J shocks	IK10

## Code system

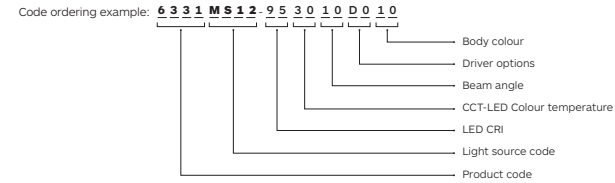

LED CRI		Driver Options		Body Colour	
80	CRI > 80	00	No Driver	10	Black
90	CRI > 90	D0	No dimming	11	White
95	CRI > 95	DL	Laser Dim	17	Black / White (B&W)
		DA	Dali Dim	26	White / Gold (W&G)
		DP	Phase	27	Chrome Polished
		DX	DMX	28	Brass Polished
		DC	CASAMBI	29	Grey (for Outdoor use)
		D1	0-10 Dim	33	Silver
				34	Nickel
				35	Gold
				54	Sanded White (for outdoor use)
				55	Red
				74	Nickel Polished
				75	Grey (RAL 9006)
				79	Natural Aluminium
				84	Stainless Steel
				92	Black / Grey (B&G)

CCT-LED Colour temperature	
27	Warm White 2700K
30	Warm White 3000K
40	Neutral White 4000K
50	Cool White 5000K
57	Cool White 5700K
TW	Tuneable White 1800K - 6000K

## How to order

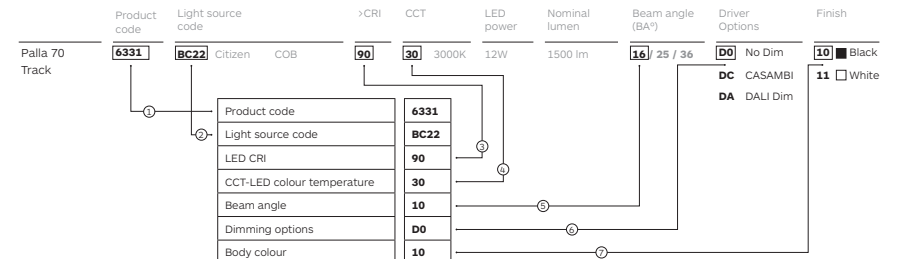

All dimensions in the catalogue in mm.

## Quick product search

Art. code	Page	Art. code	Page	Art. code	Page	Art. code	Page	Art. code	Page
<b>1020</b>	187	<b>1236</b>	214	<b>1374</b>	285	<b>2102</b>	166	<b>2286</b>	168
	191		215	<b>1379</b>	183		167	<b>2287</b>	168
<b>1021</b>	187	<b>1248</b>	209		184	<b>2103</b>	166	<b>2288</b>	168
	191	<b>1249</b>	209	<b>1380</b>	183		167	<b>2321</b>	81
<b>1024</b>	188	<b>1258</b>	345		184	<b>2104</b>	166		87
	191	<b>1259</b>	345	<b>1381</b>	183		167	<b>2322</b>	327
<b>1025</b>	188	<b>1273</b>	206		184	<b>2105</b>	167		341
	191		207	<b>1382</b>	171	<b>2106</b>	167	<b>2327</b>	81
<b>1151</b>	193	<b>1276</b>	206	<b>1383</b>	171	<b>2108</b>	167		87
<b>1152</b>	193		207	<b>1387</b>	173	<b>2137</b>	303		105
<b>1158</b>	196	<b>1280</b>	206	<b>1388</b>	173		311	<b>2328</b>	327
	197		207	<b>1389</b>	173	<b>2194</b>	166	<b>2329</b>	327
<b>1159</b>	195	<b>1283</b>	205	<b>1390</b>	173		167	<b>2330</b>	327
	197		207	<b>1391</b>	173	<b>2200</b>	281		341
<b>1164</b>	211	<b>1286</b>	205	<b>1392</b>	173	<b>2201</b>	281		374
<b>1165</b>	211		207	<b>1393</b>	175	<b>2231</b>	374	<b>2334</b>	81
<b>1166</b>	211	<b>1289</b>	205	<b>2049</b>	167	<b>2232</b>	191		87
<b>1167</b>	211		207	<b>2064</b>	374	<b>2233</b>	191		105
<b>1168</b>	211	<b>1328</b>	179	<b>2065</b>	53	<b>2235</b>	166	<b>2355</b>	303
<b>1177</b>	189		180		65		167		307
	191	<b>1331</b>	179	<b>2089</b>	166	<b>2236</b>	166		311
<b>1195</b>	189		180	<b>2090</b>	166		167		374
	191	<b>1334</b>	179	<b>2091</b>	166	<b>2237</b>	166	<b>2359</b>	311
<b>1198</b>	199		180	<b>2092</b>	166		167	<b>2361</b>	165
	200	<b>1345</b>	177	<b>2093</b>	166	<b>2238</b>	166		197
<b>1206</b>	199	<b>1346</b>	177	<b>2094</b>	166		167	<b>2362</b>	165
	200	<b>1350</b>	177	<b>2095</b>	166	<b>2239</b>	166		197
<b>1210</b>	203	<b>1351</b>	177		167		167	<b>2367</b>	91
<b>1211</b>	203	<b>1361</b>	199	<b>2096</b>	166	<b>2240</b>	166		161
<b>1212</b>	203		200		167		167		201
<b>1231</b>	213	<b>1362</b>	199	<b>2097</b>	166	<b>2241</b>	166	<b>2368</b>	91
	215		200		167		167		161
<b>1232</b>	213	<b>1363</b>	199	<b>2098</b>	166	<b>2242</b>	166		201
	215		200		167		167	<b>2372</b>	374
<b>1233</b>	213	<b>1364</b>	199	<b>2099</b>	166	<b>2243</b>	168	<b>2373</b>	374
	215		200		167	<b>2244</b>	168	<b>2375</b>	374
<b>1234</b>	214	<b>1367</b>	188	<b>2100</b>	166	<b>2268</b>	209	<b>2378</b>	374
	215		191		167	<b>2278</b>	168	<b>2379</b>	354
<b>1235</b>	214	<b>1371</b>	285	<b>2101</b>	166	<b>2279</b>	168	<b>2380</b>	354
	215	<b>1372</b>	285		167	<b>2280</b>	209	<b>2381</b>	354
		<b>1373</b>	285			<b>2285</b>	168	<b>2382</b>	354

Art. code	Page	Art. code	Page	Art. code	Page	Art. code	Page	Art. code	Page
<b>2394</b>	354	<b>2592</b>	341	<b>2715</b>	311	<b>2A54</b>	139	<b>2B95</b>	37
<b>2395</b>	354	<b>2593</b>	341	<b>2790</b>	249		153		149
<b>2418</b>	87	<b>2598</b>	81	<b>2791</b>	243		181		161
<b>2477</b>	243		87	<b>2924</b>	245		223		185
			105	<b>2974</b>	247	<b>2A58</b>	139		201
<b>2478</b>	303	<b>2599</b>	81	<b>2983</b>	249		181		227
	315		87	<b>2986</b>	249		223	<b>2B96</b>	149
	355		105	<b>2A46</b>	139	<b>2A59</b>	47		185
<b>2479</b>	303	<b>2601</b>	374		181		139	<b>2B97</b>	149
	315	<b>2607</b>	327		223		153		185
	355	<b>2608</b>	327	<b>2A47</b>	47		181	<b>2B98</b>	149
<b>2494</b>	281	<b>2609</b>	327		139		223		185
<b>2495</b>	281	<b>2610</b>	327		153	<b>2A60</b>	139	<b>2B99</b>	37
<b>2504</b>	69	<b>2614</b>	69		181		153		149
	105		105		223		181		185
	117		117	<b>2A48</b>	139		223		227
<b>2507</b>	361	<b>2615</b>	69		153	<b>2A63</b>	139	<b>2C01</b>	149
<b>2508</b>	361		105		181		181		185
<b>2509</b>	341		117		223		223	<b>2C02</b>	149
	374	<b>2616</b>	307	<b>2A49</b>	139	<b>2A64</b>	139		185
<b>2510</b>	341	<b>2619</b>	311		181		153	<b>2C03</b>	149
	374	<b>2633</b>	53		223		181		185
<b>2514</b>	307		81	<b>2A50</b>	47		223	<b>2C04</b>	37
<b>2515</b>	307		87		139	<b>2A65</b>	139		149
<b>2563</b>	361	<b>2634</b>	81		153		153		185
<b>2564</b>	361		87		181		181		227
<b>2565</b>	354		111		223		223	<b>2C05</b>	149
<b>2566</b>	354	<b>2652</b>	374	<b>2A51</b>	139	<b>2B69</b>	81		185
<b>2567</b>	354	<b>2661</b>	65		153		87	<b>2C06</b>	149
<b>2568</b>	354		69		181	<b>2B82</b>	87		185
<b>2569</b>	354		105		223	<b>2B87</b>	53	<b>2C07</b>	149
<b>2570</b>	355	<b>2662</b>	81	<b>2A52</b>	139		81		185
<b>2571</b>	355		87		181		87	<b>2C23</b>	351
<b>2576</b>	315		111		223	<b>2B88</b>	53	<b>2C24</b>	351
<b>2577</b>	281	<b>2663</b>	81	<b>2A53</b>	47		81	<b>2C25</b>	351
	303		87		139		87	<b>2C26</b>	351
	307		111		153	<b>2B89</b>	91	<b>2C27</b>	351
	311	<b>2675</b>	69		181	<b>2B90</b>	91	<b>2C28</b>	351
	341		105		223			<b>2C29</b>	351
	355		191					<b>2C30</b>	351
	374	<b>2688</b>	311					<b>2C31</b>	351

## Quick product search

Art. code	Page	Art. code	Page	Art. code	Page	Art. code	Page	Art. code	Page
2C32	351	3276	335	3459	309	3512	299	5772	89
2C33	173	3277	335	3460	309		302		90
	191		337	3465	310	3533	359	6093	163
	217	3292	335	3466	310	3535	301		165
	351		337	3467	310		302	6094	164
2C34	173	3310	305	3474	371		303		165
	217		306	3476	369	3547	367	6274	155
2C35	173	3311	305	3480	343	3548	363	6276	155
	217		306	3481	343	3550	357	6287	164
2C36	173	3312	305	3482	343	3551	301		165
	217		306	3483	343		302	6288	163
2C37	351	3325	336	3484	343		303		165
2C38	351	3328	336	3485	343	3556	360	6323	159
2C39	351	3331	336	3486	353	3557	359		160
2C40	351	3333	336	3487	353	3558	359	6328	157
2C41	351	3338	339	3488	353	3559	360	6329	157
2C42	351	3339	339	3489	330	3560	359	6331	147
2C43	351	3341	339	3490	330	3561	360		148
2C44	87	3343	339	3491	331	3562	357	6332	147
2C45	53	3346	340	3492	331	3585	349		148
	65	3347	340	3493	331	3586	349	6333	147
2C46	53	3349	340	3494	329	3587	349		148
	65	3351	340	3495	329	3588	349	6438	137
3073	313	3414	371	3496	326	3589	350		138
	314	3415	371	3497	325	3590	350	6445	151
3075	313	3418	373	3498	326	3591	350		153
	314	3419	373	3499	325	4204	245	6447	137
3094	333	3437	323	3500	305	4205	245		138
3095	333	3438	323		306	4208	245	6450	151
3096	333	3441	319	3501	305	4209	245		153
3097	333	3444	319		306	4268	281	6455	137
3098	333	3447	319	3502	305	5001	71		138
3099	333	3450	319		306	5002	71	6478	152
3139	365	3451	317	3503	347	5085	61		153
3157	300	3452	317	3504	347		64	6479	152
	302	3453	317	3505	347	5086	61		153
	303	3454	317	3506	347		64	6480	145
3198	353	3455	317	3507	321	5338	51	6481	145
3199	353	3456	317	3508	321		52	6482	145
3200	353	3457	309	3509	321	5643	51	6483	143
3269	335	3458	309	3510	365		52	6484	141

Art. code	Page	Art. code	Page	Art. code	Page	Art. code	Page	Art. code	Page
6485	142	7189	221	8132	287	G040MLHJ	277	G1FS	258
6489	135		222	8133	287	G040MLVJ	277		259
	138	7205	219	8134	287	G040MT3J	277	G1N1	268
6490	135	7211	219	8135	287	G040MX4J	277	G1NB	268
	138	7212	233	8136	287	G060C	277		269
6492	159	7231	225	8137	287	G060D	277	G1NI	269
	160		226	8301	288	G060ECF	277	G1NS	268
6494	159	7232	225	8303	288	G060ECM	277		269
	160		226	8307	289	G060FLHJ	277	G1PB	274
6526	135	7233	225	8309	289	G060FLVJ	277		275
	138		226	8361	281	G060FT3J	277	G1PI	274
6533	133	7234	217	8362	281	G060FX4J	277		275
6534	133	7235	217	8363	281	G060MLHJ	277	G1PS	274
6536	133	7236	217	8364	281	G060MLVJ	277		275
6537	135	7237	217	8370	288	G060MT3J	277	G1WB	264
7115	237	7238	217	8373	281	G060MX4J	277		265
7116	237	7239	217	8390	292	G095C	277	G1WI	264
7117	237	7240	217		295	G095D	277		265
7119	239	7241	217	8391	292	G095ECF	277	G1WS	264
	241	7243	283		295	G095ECM	277		265
7120	239	7244	283	8392	292	G095ECU	277	G4CB	261
	241	7245	283		295	G095FLHJ	277		265
7121	239	7246	284	8393	292	G095FLVJ	277	G4CI	261
	241	7247	284		295	G095FT3J	277		265
7122	240	7248	284	8394	293	G095FX4J	277	G4CS	261
	241	7249	283		295	G095MLHJ	277		265
7123	240	7250	283	8395	293	G095MLVJ	277	G4FB	255
	241	7251	283		295	G095MT3J	277		259
7124	240	7252	284	8396	293	G095MX4J	277	G4FI	253
	241	7253	284		295	G160C	277		255
7143	230	7254	284	8397	293	G160D	277	G4FS	255
7146	230	7255	235		295	G160ECM	277		259
7150	230	8101	287	G040C	277	G160MLHJ	277	G4MB	255
7153	229	8102	287	G040D	277	G160MLVJ	277		259
7156	229	8103	287	G040ECF	277	G160MT3J	277	G4MI	255
7159	229	8104	287	G040ECM	277	G160MX4J	277		259
7163	233	8105	287	G040ECU	277	G1FB	258	G4MS	255
7168	221	8110	287	G040FLHJ	277		259	G4NB	267
	222	8115	287	G040FLVJ	277	G1FI	258		269
7188	221	8130	287	G040FT3J	277		259	G4NI	267
	222	8131	287	G040FX4J	277				269

## Quick product search

Art. code	Page	Art. code	Page	Art. code	Page	Art. code	Page	Art. code	Page
G4NS	267	G6PS	272	G9US	273	RC48	56	RD98	59
	269		275		275		57	RE03	74
G4PB	271	G6WB	262	G9WB	263	RD18	130		75
	275		265		265		131	RE04	74
G4PI	271	G6WI	262	G9WI	263	RD26	130		75
	275		265		265		131	RE05	74
G4PS	271	G6WS	262	G9WS	263	RD29	89		75
	275		265		265		90	RE06	74
G4UB	271	G9CB	263	GELS	277	RD31	126		75
	275		265	GSUS	277		127	RE07	74
G4UI	271	G9CI	263	R024	23	RD32	125		75
	275		265	R028	15		127	RE08	74
G4US	271	G9CS	263		23	RD33	126		75
	275		265	R031	23		127	RE09	73
G4WB	261	G9FB	257	RA05	97	RD34	125		75
	265	G9FI	257		104		127	RE10	73
G4WI	261		259	RA06	97	RD35	126		75
	265	G9FS	257		104		127	RE11	73
G4WS	261		259	RA07	99	RD36	125		75
	265	G9MB	257		104		127	RE12	73
G6FB	256		259	RA08	99	RD37	248		75
	259	G9MI	257		104	RD38	248	RE13	73
G6FI	256		259	RA09	101	RD39	248		75
	259	G9MS	257		104	RD40	248	RE14	73
G6FS	256	G9N1	268	RA10	101	RD53	59		75
G6MB	256	G9NB	268		104	RD54	59	RE19	129
	259		269	RA11	103	RD55	125		131
G6MI	256	G9NI	269		104		127	RE20	129
G6MS	256	G9NS	268	RA12	103	RD56	126		131
	259		269		104		127	RE21	129
G6NB	267	G9PB	273	RB04	243	RD57	125		131
	269		275	RC43	56		127	RE22	129
G6NI	267	G9PI	273		57	RD58	126		131
	269		275	RC44	56		127	RE23	129
G6NS	267	G9PS	273		57	RD59	125		131
	269		275	RC45	56		127	RE24	129
G6PB	272	G9UB	273		57	RD60	126		131
	275		275	RC46	56		127	RE25	130
G6PI	272	G9UI	273		57	RD97	59		131
	275		275	RC47	56			RE26	130
					57				131

Art. code	Page	Art. code	Page	Art. code	Page	Art. code	Page	Art. code	Page
RE27	130	RG16	68	RH01	79	RH92	45	RJ35	39
	131		69		80		47	RJ36	39
RE28	130	RG17	68	RH02	79	RI41	35	RJ37	39
	131		69		80		36	RJ38	39
RE29	89	RG18	68	RH13	97	RI47	35	RJ39	39
	90		69		104		36	RJ40	39
RE47	119	RG19	68	RH14	97	RI53	35	RJ41	39
RE48	119		69		104		36	RJ42	39
RF06	31	RG30	16	RH15	99	RI59	35	RJ43	39
	36		23		104		36	RJ44	41
RF07	31	RG31	16	RH16	99	RI65	35	RJ45	41
	36		23		104		36	RJ46	41
RF10	31	RG38	15	RH17	101	RI71	35	RJ47	41
	36		23		104		36	RJ48	41
RF11	31	RG39	15	RH18	101	RJ02	19	RJ49	41
	36		23		104		23	RJ54	46
RF14	31	RG46	17	RH19	103	RJ03	18		47
	36		23		104		23	RJ55	46
RF15	31	RG47	17	RH20	103	RJ04	19		47
	36		23		104		23	RJ56	46
RF55	98	RG52	22	RH31	94	RJ05	18		47
	104		23		95		23	RJ57	46
RF56	98	RG53	22	RH34	248	RJ11	109		47
	104		23	RH51	19		111	RJ61	46
RF57	102	RG70	21		23	RJ21	84		47
	104		23	RH52	18		86	RJ62	46
RF58	104	RG71	21		23	RJ22	84		47
	104		23	RH53	19		86	RJ63	93
RF80	55	RG78	20		23	RJ23	84		95
	57		23	RH54	18		86	RJ64	93
RF88	55	RG79	20		23	RJ29	94		95
	57		23	RH87	45		95	RJ68	93
RF94	55	RG96	67		47	RJ30	94		95
	57		69	RH88	45		95	RJ72	93
RG01	55	RG97	67		47	RJ31	94		95
	57		69	RH89	45		95	RJ76	93
RG04	79	RG98	67		47	RJ32	94		95
	80		69	RH90	45		95	RJ77	93
RG05	79	RG99	67		47	RJ33	94		95
	80		69	RH91	45		95	RJ91	55
					47	RJ34	39		57



## Quick product search

Art. code	Page	Art. code	Page	Art. code	Page	Art. code	Page	Art. code	Page
RJ92	55	RL31	85	RN23	97	RN71	29	RN97	26
	57		86		104		36		27
RK12	123	RL32	85	RN24	97	RN72	33	RN98	34
RK13	123		86		104		36		36
RK15	123	RL38	113	RN25	101	RN73	33	RN99	34
RK65	49		116		104		36		36
RK66	49	RL42	114	RN26	101	RN74	33	RO01	26
RK67	49		116		104		36		27
RK68	49	RL46	115	RN41	62	RN75	33	RO02	26
RK86	83		116		64		36		27
	86	RL48	110	RN42	63	RN76	33	RO03	34
RK87	83		111		64		36		36
	86	RL52	79	RN45	62	RN77	33	RO04	34
RK88	83		80		64		36		36
	86	RL53	79	RN46	63	RN84	30	RO19	13
RK89	83		80		64		36		23
	86	RL54	109	RN56	115	RN85	30	RO20	13
RK90	83		111		116		36		23
	86	RL55	110	RN57	113	RN86	25	RO21	13
RK91	83		111		116		27		23
	86	RL59	107	RN58	114	RN87	25	RO22	13
RK96	113	RL60	107		116		27		23
	116	RL65	43	RN59	14	RN88	30	RO23	77
RL01	114	RL66	43		23		36	RO24	15
	116	RL67	43	RN60	14	RN89	30	RO25	16
RL05	115	RL68	43		23		36		23
	116	RL69	43	RN61	14	RN90	25	RO26	20
RL24	84	RL70	43		23		27		23
	86	RL71	40	RN62	14	RN91	25	RO27	21
RL25	84	RL72	40		23		27		23
	86	RL73	40	RN66	29	RN92	30	RO29	16
RL26	84	RL74	40		36		36		23
	86	RL75	40	RN67	29	RN93	30	RO30	20
RL27	85	RL76	40		36		36		23
	86	RL77	40	RN68	29	RN94	34	RO31	21
RL28	85	RL78	40		36		36	RO32	77
	86	RL79	39	RN69	29	RN95	34	RO33	77
RL29	85	RL83	39		36		36	RO38	16
	86	RL85	121	RN70	29	RN96	26		23
RL30	85	RL86	121		36		27	RO39	21
	86								23

Art. code	Page
RO40	14
	23
RO41	19
	23
RO44	77



## Global presence

Celebrating 50 years of vision, dedication and innovation, Formalighting's versatile and high-quality product offerings extends internationally via our headquarters in Hong Kong, London, Milan, Shanghai and the USA. Our well chosen and selected partners as well as our affiliated international offices broaden our global presence further in markets such as Australia, Japan, South East Asia, India and the Middle East.

Through our commitment to growth and investment within formalighting's professional team, infrastructure and product ranges, we are able to provide increasing service to our global retail and hospitality clients as well as lighting designers and specifiers strengthening our position as a leading international supplier of innovative architectural lighting solutions and systems.

With 50 years' experience in designing and manufacturing architectural lighting, formalighting's comprehensive portfolio offers a competitive range of European designed and expertly engineered products that carry CB, CE, CCC and UL certifications.

Furthermore formalighting's latest award-winning motorized range of track, pendant, and recessed fixtures, featuring remote-controlled adjustable pan and tilt, dim, dim to warm, tuneable white and beam shaping lens, are available worldwide incorporating the latest, most advanced lighting technologies.

## Headquarters

### Europe / Milan

Tel (+39) 02 9354 0300

Fax (+39) 02 9343 5117

E-mail [formaitalia@formalighting.it](mailto:formaitalia@formalighting.it)

### Asia / Hong Kong

Tel (+ 852 ) 2516 6500

Fax (+ 852 ) 2516 6525

E-mail [forma@forma.com.hk](mailto:forma@forma.com.hk)

### USA / Atlanta, GA

Tel (+ 800 ) 906 - 5088

E-mail [forma@formalightingusa.com](mailto:forma@formalightingusa.com)

Formalighting is constantly developing and improving its products therefore all information, drawings illustrations, specifications, photometric values in this catalogue are indicative and shall not form part of any commitment to our company that reserve the right to change specifications without prior notification or public announcement. Technical information on the installation-instruction has precedence over the information in the catalogue. Our general terms and conditions shall apply notwithstanding any stipulation on the contrary to all the orders and agreement with formalighting. You can obtain a copy of these conditions on demand.

Publication date: April 2018  
©Copyright formalighting

With thank to all contributors for the realization of this catalogue

Designed by formalighting Graphic Design Department

No part of this catalogue may be copied without written authorization of formalighting



# formalighting

HONG KONG

-

LONDON

-

MILAN

-

SHANGHAI

-

USA